

GTV



KATALOG PRODUKTÓW | **PRODUCT CATALOGUE** | **КАТАЛОГ ПРОДУКЦИИ**

gtv.com.pl

OŚWIETLENIE MEBLOWE
FURNITURE LIGHTING
МЕБЕЛЬНОЕ ОСВЕЩЕНИЕ

SYSTEMY PRZESUWNE
SLIDING DOOR SYSTEMS
РАЗДВИЖНЫЕ СИСТЕМЫ

AKCESORIA DEKORACYJNE
DECORATIVE ACCESSORIES
ЛИЦЕВАЯ ФУРНИТУРА

AKCESORIA FUNKCYJNE
FUNCTIONAL ACCESSORIES
ФУНКЦИОНАЛЬНАЯ ФУРНИТУРА

PL GTV to międzynarodowy producent akcesoriów meblowych i oświetlenia. Jest jedną z najdynamiczniej rozwijających się firm w Polsce. Spółka obecna jest na kilkudziesięciu rynkach w Europie, Azji i Ameryce, a produkty z logo GTV znajdują się w milionach domów i biur na całym świecie. GTV jest firmą w 100% z polskim kapitałem. Spółka dysponuje własnym zapleczem techniczno-logistycznym umożliwiającym swobodne prowadzenie działalności o ogólnoświatowym zasięgu. Siedziba firmy to nowoczesne, w pełni zinformatyzowane centrum logistyczne w Pruszkowie, w pobliżu autostrady A2. Na jego terenie znajduje się biurowiec oraz dwa magazyny o powierzchni 27 000 m kw. z wydzielonymi składami celnymi, mieszczące 35 000 europalet. Portfolio GTV to jedna z najbardziej kompletnych ofert na rynku. Obejmuje kilka tysięcy produktów, w kilkudziesięciu grupach produktowych, w tym m.in.: zawiasy, prowadnice, podnośniki, uchwyty, wyposażenie garderoby i kuchni oraz oświetlenie LED.

EN GTV is an international producer of furniture accessories and LED lighting. GTV has over 20 years of experience in cooperation with the largest furniture manufacturers in the world and millions of customers using the company's products. Today GTV is one of the international leaders in distribution of furniture accessories and LED lighting, present on dozens of markets worldwide. GTV's headquarter is a modern logistics center, located 25 km from the center of the Polish capital, Warsaw. GTV's head office is a four-story office building and two warehouses on an area of 27000 square meters with storage capacity of over 35,000 euro pallets. With its modern infrastructure, the company is able to fulfill orders from all over the world at the time indicated by the customer. GTV implementing its long-term business strategy, actively promotes its products by participating in the world's most prestigious trade fairs e.g. in Russia, Germany, Italy, Poland, Brazil. Professional service, competent team of specialists and transparent procedures allow us to effectively meet the needs of business partners.

RU GTV – это международный производитель мебельной фурнитуры и освещения. Мы работаем в десятках стран Европы, Азии и Америки, а продукция с логотипом GTV известна во всем мире. GTV – это современный, полностью информатизированный логистический центр возле Варшавы. На его территории находится офисное здание и два склада площадью 27 000 м2 с отдельными таможенными складами вместимостью 35 000 европаллет. Дополнительно фирма располагает складскими помещениями площадью почти 5000 квадратных метров. Ассортимент компании GTV включает несколько тысяч наименований продукции: петли, направляющие, подъемники, ручки, оснащение для гардероба и кухни, светодиодное освещение.





GTV

FURNITURE
ACCESSORIES

PL GTV Furniture Accessories, marka obecna na rynku od ponad dwudziestu lat to niekwestionowany lider dostarczający najbardziej kompletne portfolio akcesoriów dla branży meblarskiej. Dzięki przemyślanej strategii rozwoju, marka oferuje nieosiągalną dla innych firm relację ceny do jakości, dostarczając funkcjonalne oraz zaprojektowane zgodnie z najnowszymi trendami produkty w przystępnych cenach.

EN GTV Furniture Accessories brand is present on the market for over 20 years, building its position as one of the international leaders. The company is present in Europe, Asia and America, whereas products with the GTV logo are to be found in millions of households and offices worldwide. Thanks to carefully planned strategy and logistics, GTV can offer products with an unreachable for other companies price to quality ratio.

RU Мебельная фурнитура с логотипом GTV известна на рынке уже более двадцати лет, а портфолио компании является одним из наиболее полных предложений на мебельном рынке. Благодаря продуманной стратегии развития, эффективному управлению и открытости к новым идеям, компания GTV быстро стала лидером в дистрибуции мебельной фурнитуры. Секрет успеха компании заключается в предоставлении продукции высокого качества по приемлемой цене.

GTV

SLIDING DOOR SYSTEMS

- PL** GTV Sliding Door Systems, to marka która powstała w 2014 r. z myślą o profesjonalistach poszukujących rozwiązań ułatwiających i przyspieszających montaż drzwi przesuwanych. Systemy przesuwne zostały zaprojektowane przez naszych konstruktorów, dla których inspiracją były opinie polskich stolarzy. Dzięki tej owocnej współpracy powstał produkt, który nie tylko przekonuje praktycznymi, konstrukcyjnymi ulepszeniami. Są to również szczegóły decydujące o przewadze produktu jak unikatowy materiał, z którego wykonane zostały kółka w systemach jezdnych.
- EN** GTV Sliding Door Systems is a brand developed in 2014, for professionals seeking reliability and highest quality. Our systems have been created to meet the needs, of the most demanding customers. The idea behind the systems was inspired by carpenters, who tend to look for solutions, that will make their work more effective. GTV Sliding Door Systems offer not only practical constructional improvements. But also highest quality of components. The whole system is based on reliable elements, especially rollers thanks to which this system stands out of the competition. All of the functional accessories have been carefully selected and underwent thorough strict quality control.
- RU** Раздвижные системы GTV - бренд, созданный в 2014 году с мыслью о профессионалах, ищущих новые возможности, позволяющие ускорить процесс установки раздвижных дверей. Раздвижные системы GTV были запроектированы по инициативе производителей мебели и являются авторской разработкой инженеров компании GTV. В результате плодотворной работы был создан продукт, интересный не только своими техническими решениями, но и отличающийся качеством используемого материала в нижних ходовых элементах.

GTV

LIGHTING

- PL** Marka GTV Lighting została wprowadzona na rynek 2007 r. oferując rozwiązania oświetleniowe przeznaczone do biur, budynków przemysłowych, magazynowych i użyteczności publicznej opartych na technologii LED. Portfolio zawiera również produkty LED dla klientów indywidualnych – źródła LED, oświetlenie meblowe. GTV Lighting to szeroka i kompletna oferta, elastyczność w podejściu do partnerów biznesowych a także serwis.
- EN** The GTV Lighting brand was launched in 2007, it has been created, to provide professional lighting solutions for offices, industrial buildings and warehouses - based on LED technology. The portfolio also includes LED solutions for private consumers – home and garden lighting, furniture lighting. GTV Lighting offers also a wide and complete portfolio of services, such as lighting planning consulting.
- RU** Товарная группа GTV освещение появилась в ассортименте компании в 2007 году и представляет собой подборку интересных световых решений для офисов, промышленных зданий, складских помещений, общественных зданий, а также решений подходящих индивидуальным клиентам – источники светодиодного освещения и освещение для мебели. GTV освещение предлагает широкий спектр продукции и гибкость в подходе к бизнес-партнёрам и услугам, которые мы предоставляем.

AKCESORIA FUNKCYJNE FUNCTIONAL ACCESSORIES ФУНКЦИОНАЛЬНАЯ ФУРНИТУРА

Zawiasy Hinges Петли	8 – 41
Amortyzatory Buffers Амортизаторы	41 – 47 55 – 57
Podnośniki Lifts Подъёмники	48 – 57
Prowadnice Slides Направляющие	58 – 85
Systemy szuflad Drawer systems Выдвижные ящики	86 – 122
Elementy łączeniowe Brackets and fittings Соединительные элементы	127 – 156
Listwy Work top strip Планки для столешниц	157 – 159
Mocowania do rur Rails accessories and fittings Крепление для труб	159 – 179
Wyposażenie garderoby Wardrobe accessories Наполнение для шкафов-купе	180 – 204
Akcesoria kuchenne Kitchen accessories Кухонные аксессуары	124 – 126 206 – 225
Akcesoria biurowe Office accessories Аксессуары для офиса	226 – 238
Inne Other Другие	239 – 242

AKCESORIA DEKORACYJNE DECORATIVE ACCESSORIES ЛИЦЕВАЯ ФУРНИТУРА

Uchwyty Handles Ручки	246 – 323
Wieszaki Hooks Крючки	323 – 338

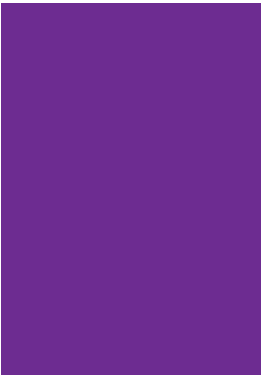

Wsporniki Shelf supports Полкодержатели	339 – 345
Nóżki meblowe Furniture legs Мебельные ножки	346 – 370
Nogi meblowe Furniture legs Мебельные опоры	371 – 387
Rolki meblowe Furniture castors Мебельные колёсики	388 – 393



SYSTEMY PRZESUWNE SLIDING DOOR SYSTEMS РАЗДВИЖНЫЕ СИСТЕМЫ

Dolny układ jezdny Bottom-running systems Нижняя ходовая система	396 – 426
Górny układ jezdny Top-running systems Верхняя ходовая система	427 – 431



OŚWIETLENIE MEBLOWE FURNITURE LIGHTING МЕБЕЛЬНОЕ ОСВЕЩЕНИЕ

Taśmy LED LED strips Светодиодные ленты	434 – 439
Profile LED LED profiles Профили LED	440 – 471
Oprawy LED LED fittings Светодиодные светильники	471 – 487
Akcesoria Accessories Аксессуары	488 – 519
Przedłużacze biurkowe Desk power sockets Выдвижные удлинители	520 – 530

**AKCESORIA FUNKCYJNE
FUNCTIONAL ACCESSORIES
ФУНКЦИОНАЛЬНАЯ ФУРНИТУРА**

Zawiasy Hinges Петли	8 – 41
Amortyzatory Buffers Амортизаторы	41 – 47 55 – 57
Podnośniki Lifts Подъёмники	48 – 57
Prowadnice Slides Направляющие	58 – 85
Systemy szuflad Drawer systems Выдвижные ящики	86 – 122
Elementy łączeniowe Brackets and fittings Соединительные элементы	127 – 156
Listwy Work top strip Планки для столешниц	157 – 159
Mocowania do rur Rails accessories and fittings Крепление для труб	159 – 179
Wyposażenie garderoby Wardrobe accessories Наполнение для шкафов-купе	180 – 204
Akcesoria kuchenne Kitchen accessories Кухонные аксессуары	124 – 126 206 – 225
Akcesoria biurowe Office accessories Аксессуары для офиса	226 – 238
Inne Other Другие	239 – 242





MB

MODERN BOX

Orientacyjna ilość zawiasów puszkowych Ø35*

* Nie dotyczy modeli specjalnych o szerokim kącie otwarcia

Approximate amount of hinges Ø35*

* Not applicable for special hinges with wide opening angle

Приблизительное количество шарнирных петель Ø35*

* Не касается специальных моделей с широким углом открывания

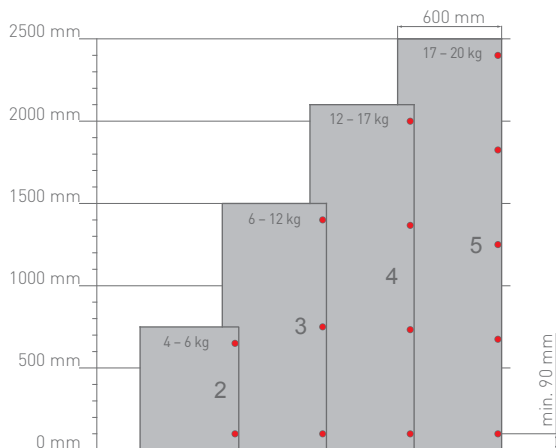

Orientacyjna ilość zawiasów puszkowych Ø26 oraz Ø35*

* Dotyczy modeli specjalnych o szerokim kącie otwarcia

Approximate amount of hinges Ø26 and Ø35*

* Applicable for special hinges with wide opening angle

Приблизительное количество шарнирных петель Ø26 и Ø35*

* Касается специальных моделей с широким углом открывания

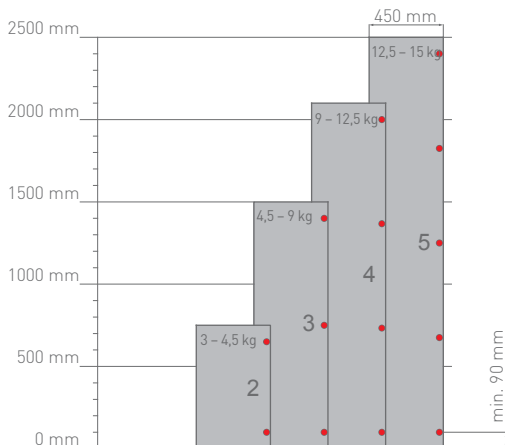

- Ilość użytych zawiasów jest zależna od wysokości, szerokości i ciężaru frontu.
- W celu zapewnienia stabilności odległość między zawiasami powinna być jak największa.
- Przed przystąpieniem do seryjnej produkcji należy przeprowadzić próbę montażu i sprawdzić poprawność funkcjonowania.
- Number of hinges that should be used, depends on the height, width and weight of the front.
- To ensure stability, the distance between the hinges should be as big as possible.
- Before starting mass production, mounting tests should be performed in order to ensure proper functioning.
- Количество использованных петель зависит от высоты, ширины и веса фасада.
- Для обеспечения стабильности, расстояние между петлями должно быть как можно больше.
- Перед началом серийного производства необходимо провести пробу монтажа и проверить исправность функциональности петель.

Zawias hydrauliczny SOLID PLUS, nakładany
 Hydraulic cup hinge SOLID PLUS, overlay door
 Гидравлическая петля SOLID PLUS, накладная

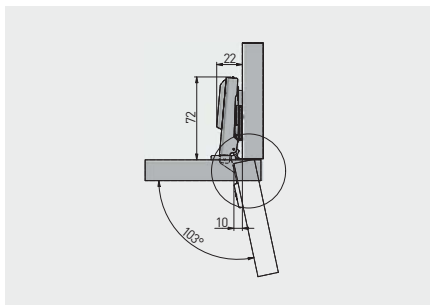

ZM-DCHC09-3DBE0	H = 0	—	—	nikiel	stal
ZM-DCHC09-3DZE0		—	x 2	nickel	steel



Zawias hydrauliczny SOLID PLUS, bliźniaczy
 Hydraulic cup hinge SOLID PLUS, twin overlay door
 Гидравлическая петля SOLID PLUS, полунакладная

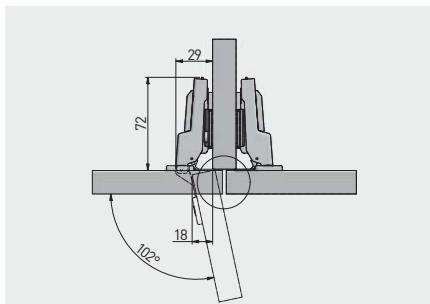

ZM-DCHC08-3DBE0	H = 0	—	—	nikiel	stal
ZM-DCHC08-3DZE0		—	x 2	nickel	steel



Zawias hydrauliczny SOLID PLUS, wpuszczany
 Hydraulic cup hinge SOLID PLUS, inset door
 Гидравлическая петля SOLID PLUS, внутренняя

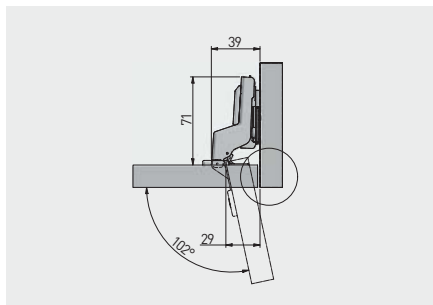

ZM-DCHC07-3DBEO	H = 0	—	—	nikiel nickel	stal steel
ZM-DCHC07-3DZEO		—	x 2	nikiel nickel	stal steel



Zawias hydrauliczny ECHC, nakładany
 Hydraulic cup hinge ECHC, overlay door
 Гидравлическая петля ECHC, накладная

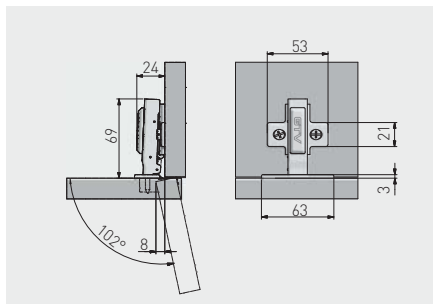

ZM-ECHC09BEO	H = 0	x 4	—	nikiel nickel	stal steel
ZM-ECHC09ZEO		x 2	x 2	nikiel nickel	stal steel





GTV

FESTO

Zawias hydrauliczny ECHC, bliźniaczy
 Hydraulic cup hinge ECHC, twin overlay door
 Гидравлическая петля ECHC, полунакладная

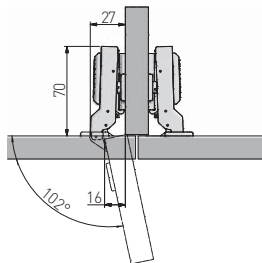

ZM-ECHC08BEO	H = 0	x 4	—	nikiel nickel нικель	stal steel сталь
ZM-ECHC08ZE0		x 2	x 2		



Zawias hydrauliczny ECHC, wpuszczany
 Hydraulic cup hinge ECHC, inset door
 Гидравлическая петля ECHC, внутренняя

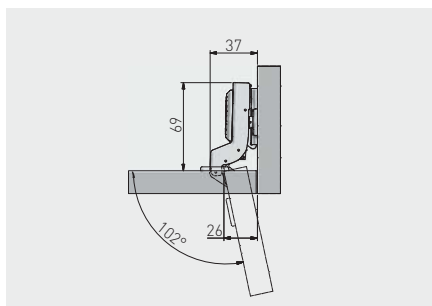

ZM-ECHC07BEO	H = 0	x 4	—	nikiel nickel нικель	stal steel сталь
ZM-ECHC07ZE0		x 2	x 2		



Zawias hydrauliczny ECHC, nakładany
 Hydraulic cup hinge ECHC, overlay door
 Гидравлическая петля ECHC, накладная

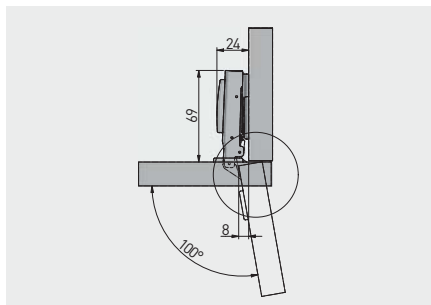

ZM-ECHC09H04-BE	H = 0	x 6	—	nikiel nickel никель	stal steel сталь



Zawias hydrauliczny ECHC, bliźniaczy
 Hydraulic cup hinge ECHC, twin overlay door
 Гидравлическая петля ECHC, полунакладная

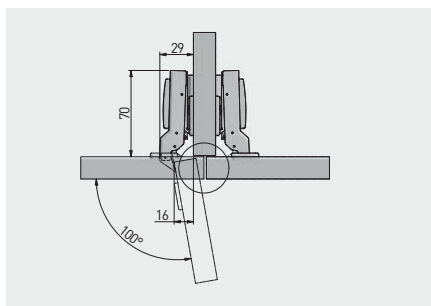

ZM-ECHC08H04-BE	H = 0	x 6	—	nikiel nickel никель	stal steel сталь



Zawias hydrauliczny ECHC, wpuszczany
 Hydraulic cup hinge ECHC, inset door
 Гидравлическая петля ECHC, внутренняя

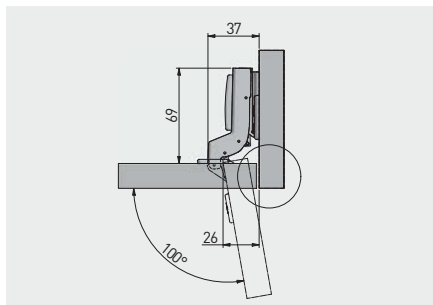

ZM-ECHC07H04-BE	H = 0	x 6	—	nikiel nickel никель	stal steel сталь



Zawias hydrauliczny ECHC3D prosty, z regulacją mimośrodową
 Hydraulic cup hinge ECHC3D with eccentric adjustment, straight
 Гидравлический шарнир ECHC3D прямой

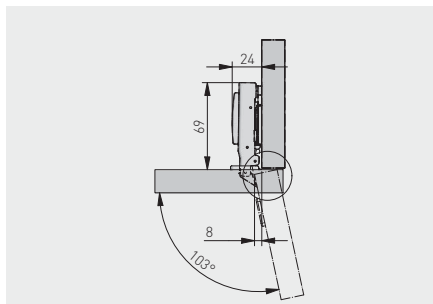

ZM-ECHC09-3DBE0	H = 0	—	—	nikiel nickel никель	stal steel сталь



Zawias hydrauliczny ECHC3D półwpuszczany z regulacją mimośrodową
 Hydraulic cup hinge ECHC with eccentric adjustment, half-overlay door
 Полууглубленный гидравлический шарнир ECHC3D

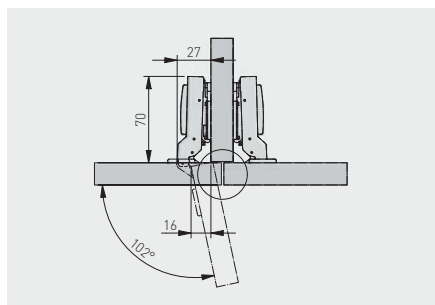

ZM-ECHC08-3DBE0	H = 0	—	—	nikiel nickel никель	stal steel сталь



Zawias hydrauliczny ECHC3D wpuszczany, z regulacją mimośrodową
 Hydraulic cup hinge ECHC with eccentric adjustment, inset door
 Гидравлический шарнир ECHC3D

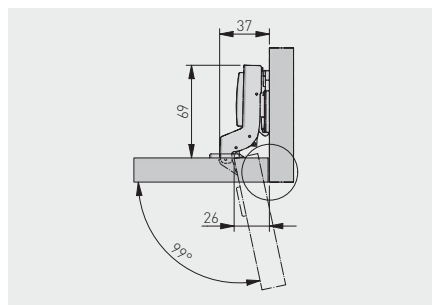

ZM-ECHC07-3DBE0	H = 0	—	—	nikiel nickel никель	stal steel сталь



Zawias hydrauliczny ECHC, wpuszczany
 Hydraulic cup hinge ECHC, inset door
 Гидравлическая петля ECHC, внутренняя

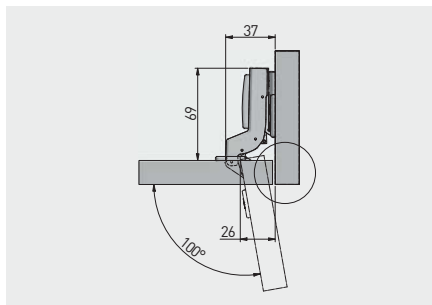

ZM-ECHC07H04-BE	H = 0	x 6	—	nikiel nickel никель	stal steel сталь



Zawias hydrauliczny CNHC z regulacją mimośrodową, nakładany
 Hydraulic cup hinge CNHC with eccentric adjustment, overlay door
 Гидравлическая петля CNHC с эксцентриком, накладная

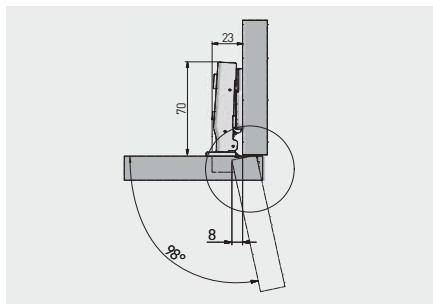

ZM-CNHC09BR2	H = 0	—	—	nikiel nickel никель	stal steel сталь



Zawias hydrauliczny CNHC z regulacją mimośrodową, bliźniaczy
 Hydraulic cup hinge CNHC with eccentric adjustment, twin overlay door
 Гидравлическая петля CNHC с эксцентриком, полунакладная

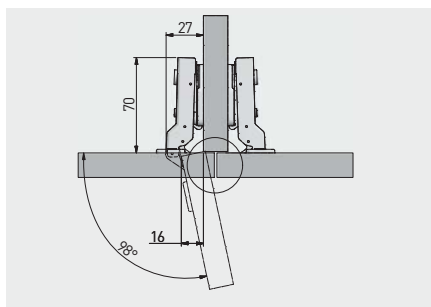

ZM-CNHC08BR2	H = 0	-	-	nikiel nickel никель	stal steel сталь



Zawias hydrauliczny CNHC z regulacją mimośrodową, wpuszczany
 Hydraulic cup hinge CNHC with eccentric adjustment, inset door
 Гидравлическая петля CNHC с эксцентриком, внутренняя

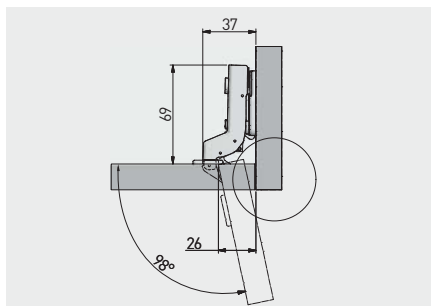

ZM-CNHC07BR2	H = 0	-	-	nikiel nickel никель	stal steel сталь



Zawias hydrauliczny INHC, nakładany
 Hydraulic cup hinge INHC, overlay door
 Гидравлическая петля INHC, накладная

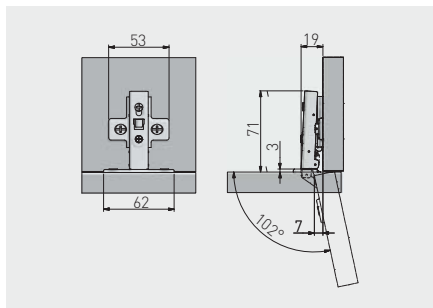

ZM-INHC090BEO	H = 0	—	—	nikiel nickel	stal steel
ZM-INHC090ZEO		—	x 2	никель	сталь



Zawias hydrauliczny INHC, bliźniaczy
 Hydraulic cup hinge INHC, twin overlay door
 Гидравлическая петля INHC, полунакладная

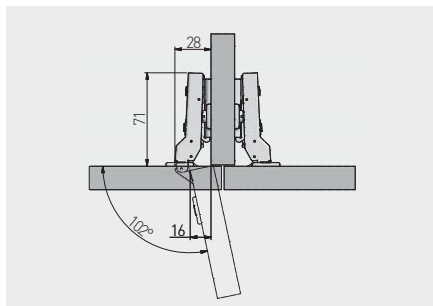

ZM-INHC080BEO	H = 0	—	—	nikiel nickel	stal steel
ZM-INHC080ZEO		—	x 2	никель	сталь



Zawias hydrauliczny INHC, wpuszczany
 Hydraulic cup hinge INHC, inset door
 Гидравлическая петля INHC, внутренняя

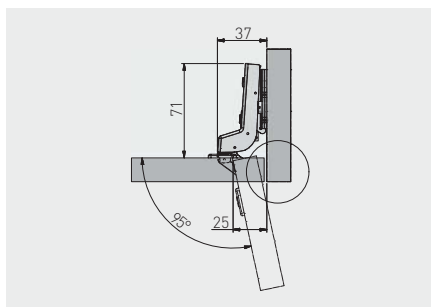

ZM-INHC070BEO	H = 0	—	—	nikiel nickel никель	stal steel сталь
ZM-INHC070ZEO		—	x 2		



Zawias kątowy 30°, hydrauliczny HCKT
 Hydraulic corner cup hinge 30° HCKT
 Угловая петля 30°, гидравлическая HCKT

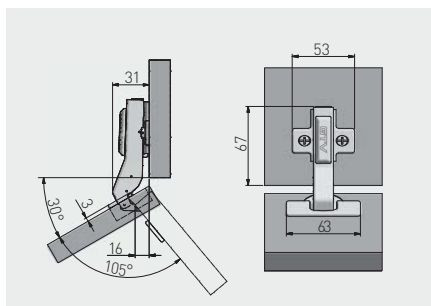

ZM-HCKT30-BE-S	H = 0	x 4	—	nikiel nickel никель	stal steel сталь
ZM-HCKT30-ZE-S		x 2	x 2		



Zawias kątowy 45° hydrauliczny HCKT
 Hydraulic corner cup hinge 45° HCKT
 Угловая петля 45°, гидравлическая HCKT

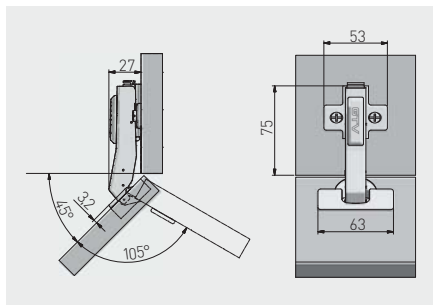

ZM-HCKT45-BE-S	H = 0	x 4	—	nikiel nickel никель	stal steel сталь
ZM-HCKT45-ZE-S		x 2	x 2		



Zawias kątowy 45° HCKT z regulacją mimośrodową
 Corner hinge 45° HCKT with eccentric adjustment
 Угловая петля 45° HCKT с эксцентриком

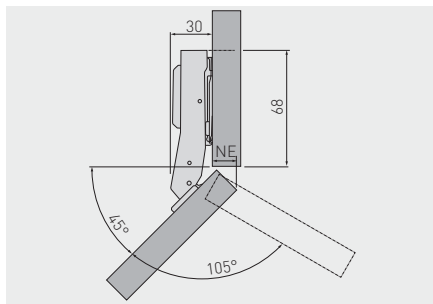

ZM-HCKT45-3DBE0-S	H = 0	—	—	nikiel nickel никель	stal steel сталь



Zawias równoległy hydrauliczny HCKT
 Parallel hydraulic hinge HCKT
 Гидравлическая петля под фальшпанель HCKT

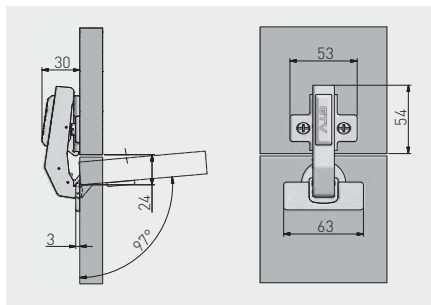

ZM-HCKT90-BE-S	H = 0	x 4	—	nikiel nickel никель	stal steel сталь
ZM-HCKT90-ZE-S		x 2	x 2		



Zawias równoległy HCKT z regulacją mimośrodową
 Parallel hinge HCKT with eccentric adjustment
 Петля под фальшпанель HCKT с эксцентриком

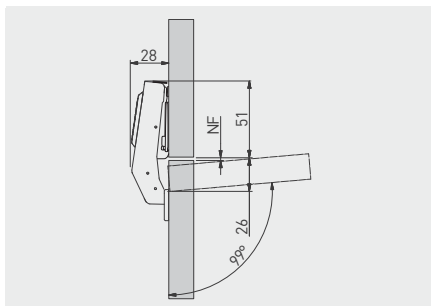

ZM-HCKT90-3DBE0-S	H = 0	—	—	nikiel nickel никель	stal steel сталь



Zawias z ujemnym uskokiem 155° hydrauliczny HCKT
 Hydraulic set-off hinge 155° HCKT
 Гидравлическая петля 155° HCKT

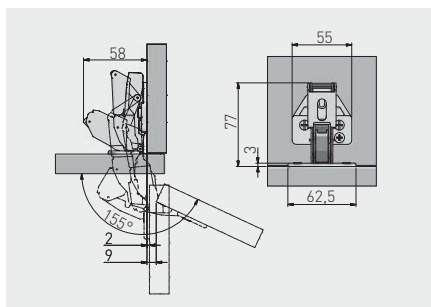

ZM-HCKT155BE	H = 0	—	—	nikiel nickel	stal steel
ZM-HCKT155ZE		—	x 2	никель	сталь



Zawias 165° hydrauliczny HCKT
 Hydraulic hinge 165° HCKT
 Гидравлическая петля 165° HCKT

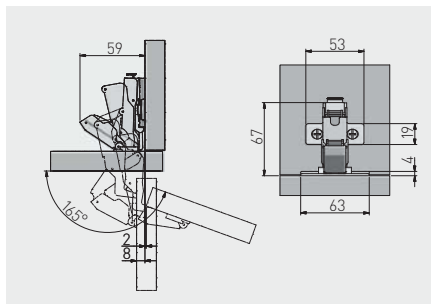

ZM-HCKT165BE-S	H = 0	—	—	nikiel nickel	stal steel
ZM-HCKT165ZE-S		—	x 2	никель	сталь



Zawias 165° hydrauliczny HCKT z regulacją mimośrodową
 Hydraulic hinge 165° HCKT with eccentric adjustment
 Гидравлическая петля 165° HCKT с эксцентриком

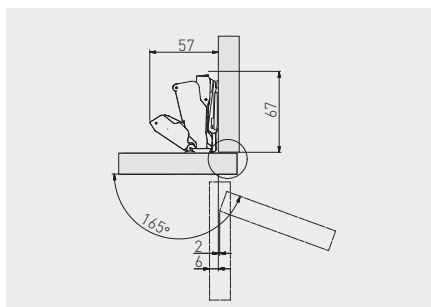

ZM-HCKT165-3DBEO-S	H = 0	—	—	nikiel nickel НИКЕЛЬ	stal steel СТАЛЬ



Zawias SOLID, nakładany
 Hinge SOLID, overlay door
 Петля SOLID, накладная

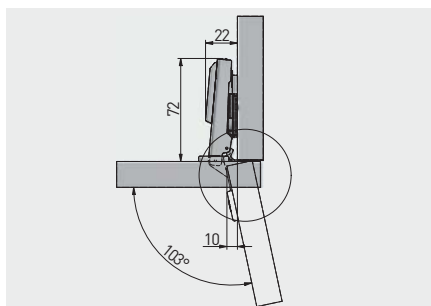

ZP-BIDI09-3DBEO	H = 0	—	—	nikiel nickel НИКЕЛЬ	stal steel СТАЛЬ



Zawias SOLID, bliźniaczy
Hinge SOLID, twin overlay door
Петля SOLID, полунакладная

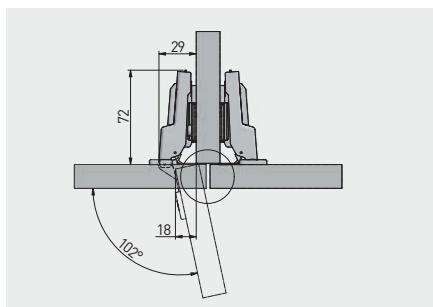

ZP-BIDI08-3DBEO	H = 0	—	—	nikiel nickel никель	stal steel сталь



Zawias SOLID, wpuszczany
Hinge SOLID, inset door
Петля SOLID, внутренняя

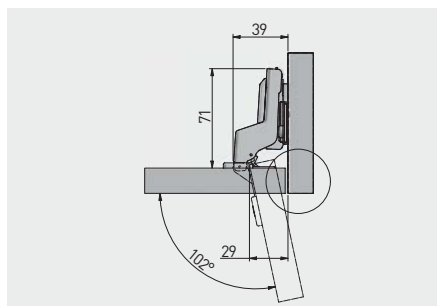

ZP-BIDI07-3DBEO	H = 0	—	—	nikiel nickel никель	stal steel сталь



Zawias CONL, nakładany
Hinge CONL, overlay door
Петля CONL, накладная

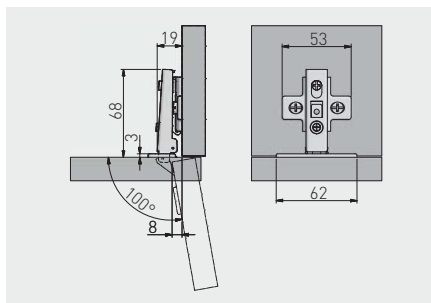

ZP-CONL09-BE	H = 0	—	—	nikiel nickel никель	stal steel сталь
ZP-CONL09-ZE		—	x 2		



Zawias CONL, bliźniaczy
Hinge CONL, twin overlay door
Петля CONL, полунакладная

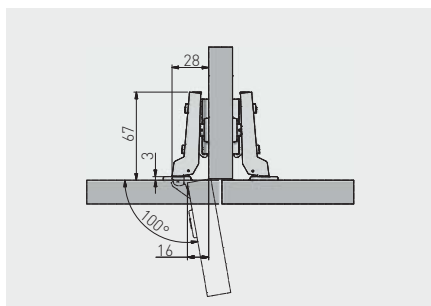

ZP-CONL08-BE	H = 0	—	—	nikiel nickel никель	stal steel сталь
ZP-CONL08-ZE		—	x 2		



Zawias CONL, wpuszczany
Hinge CONL, inset door
Петля CONL, внутренняя

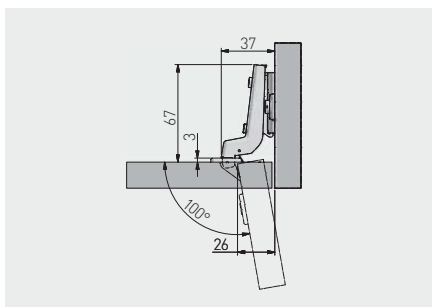

ZP-CONL07-BE	H = 0	—	—	nikiel nickel никель	stal steel сталь
ZP-CONL07-ZE		—	x 2		



Zawias BICN, nakładany
Hinge BICN, overlay door
Петля BICN, накладная

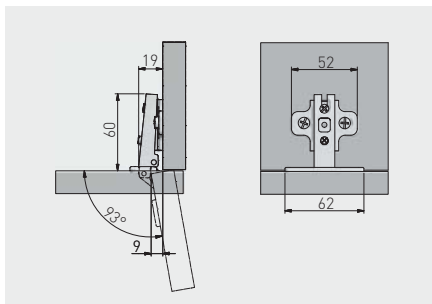

ZP-BICN090BE	H = 0	—	—	nikiel nickel никель	stal steel сталь
ZP-BICN090ZE		—	x 2		
ZP-BICN092BE	H = 2	—	—	nikiel nickel никель	stal steel сталь
ZP-BICN092ZE		—	x 2		



Zawias BICN, bliźniaczy
Hinge BICN, twin overlay door
Петля BICN, полунакладная

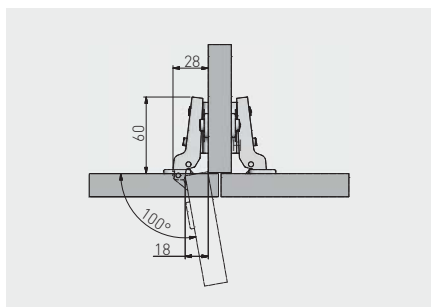

ZP-BICN080BE	H = 0	—	—	nikiel nickel никель	stal steel сталь
ZP-BICN080ZE		—	x 2		
ZP-BICN082BE	H = 2	—	—	nikiel nickel никель	stal steel сталь
ZP-BICN082ZE		—	x 2		



Zawias BICN, wpuszczany
Hinge BICN, inset door
Петля BICN, внутренняя

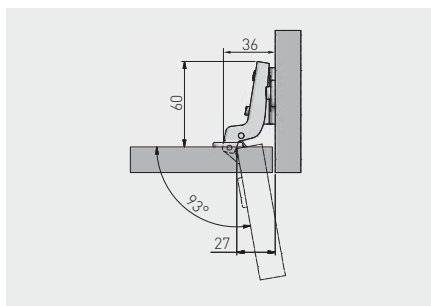

ZP-BICN070BE	H = 0	—	—	nikiel nickel никель	stal steel сталь
ZP-BICN070ZE		—	x 2		
ZP-BICN072BE	H = 2	—	—	nikiel nickel никель	stal steel сталь
ZP-BICN072ZE		—	x 2		



Zawias kątowy 30° KT
 Corner hinge 30° KT
 Угловая петля 30° KT

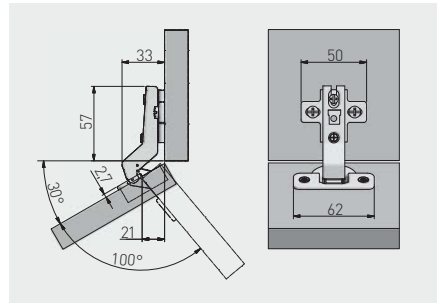

ZP-KT30H2-BE	H = 2	—	—	nikiel nickel никель	stal steel сталь



Zawias kątowy 45° KT
 Corner hinge 45° KT
 Угловая петля 45° KT

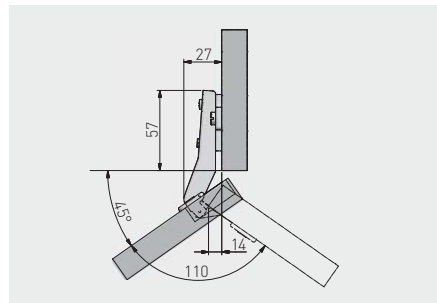

ZP-KT45H2-BE	H = 2	—	—	nikiel nickel никель	stal steel сталь
ZP-KT45H2-ZE		—	x 2		



Zawias równoległy KT
Parallel hinge KT
Петля под фальшпанель KT

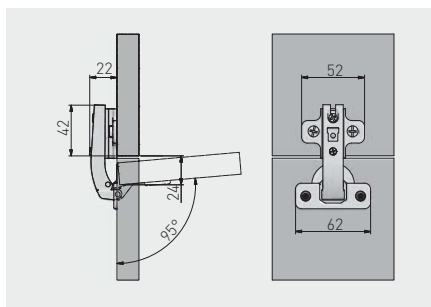

ZP-KT90H2-BE	H = 2	—	—	nikiel nickel никель	stal steel сталь
ZP-KT90H2-ZE		—	x 2		



Zawias równoległy – krótkie ramię KTK
Parallel hinge – short arm KTK
Петля под фальшпанель с коротким плечем KTK

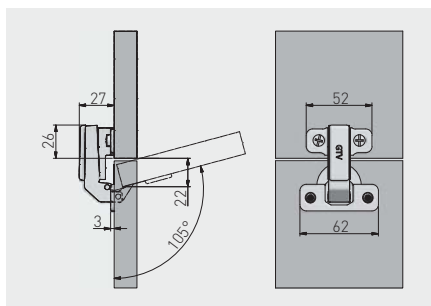

ZP-KTK90H6BE	H = 6	—	—	nikiel nickel никель	stal steel сталь
ZP-KTK90H6ZE		—	x 2		



Zawias 165° KT
Hinge 165° KT
Петля 165° KT

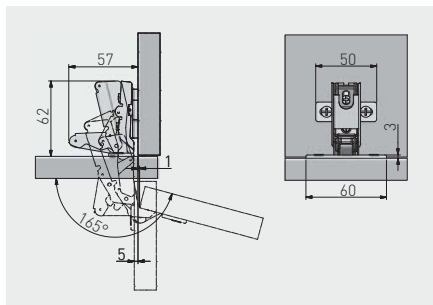

ZP-KT165H2BE	H = 2	—	—	nikiel nickel никель	stal steel сталь
ZP-KT165H2ZE		—	x 2		



Zawias uzupełniający 135° KT
Complementary hinge 135° KT
Петля для складных дверей 135° KT

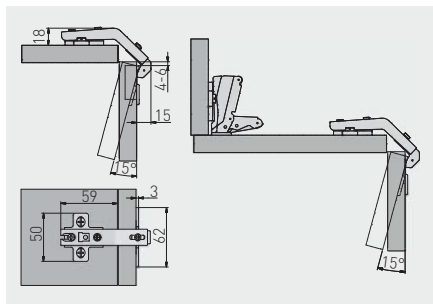

ZP-KT135H2BE	H = 2	—	—	nikiel nickel никель	stal, ZnAl steel, ZnAl сталь, ZnAl
ZP-KT135H2ZE		—	x 2		



Zawias bez sprężyny COCA, nakładany
 Hinge without spring COCA, overlay door
 Петля без пружины COCA, накладная

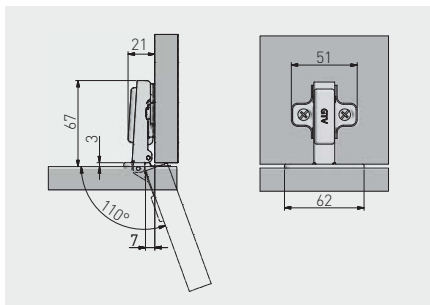

ZP-COCA450-BE	H = 0	—	—	nikiel nickel никель	stal steel сталь
ZP-COCA450-ZE		—	x 2		



Zawias bez sprężyny COCA, wpuszczany
 Hinge without spring COCA, inset door
 Петля без пружины COCA, внутренняя

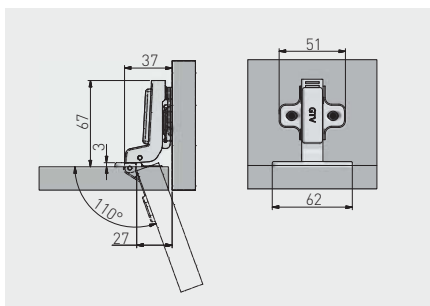

ZP-COCA7450-BE	H = 0	—	—	nikiel nickel никель	stal steel сталь



Zawias samootwierający PO, nakładany
 Self-opening hinge PO, overlay door
 Петля самооткрывающаяся PO, накладная

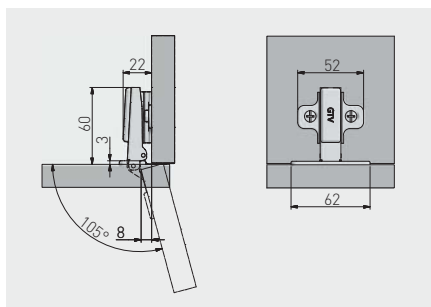

ZP-POH045BE0	H = 0	—	—	nikiel nickel	stal steel
ZP-POH045ZE0		—	x 2	nikiel nickel	stal steel



Zawias samootwierający PO, wpuszczany
 Self-opening hinge PO, inset door
 Петля самооткрывающаяся PO, внутренняя

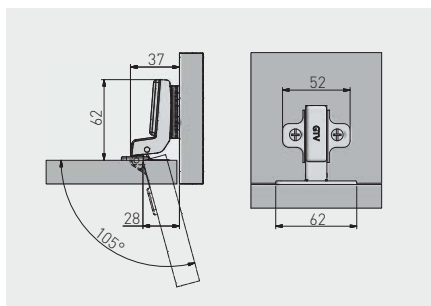

ZP-PO7H045BE	H = 0	—	—	nikiel nickel nikel	stal steel сталь



Zawias hydrauliczny mini CIHC, nakładany
 Hydraulic hinge mini CIHC, overlay door
 Гидравлическая петля мини CIHC, накладная

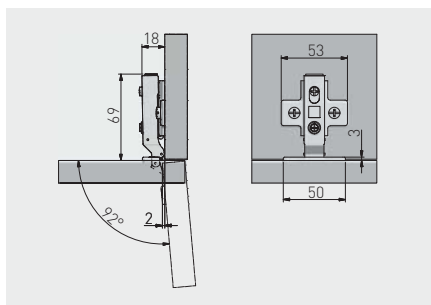

ZP-CIHC090ZE	H = 0	-	x 2	nikiel nickel нικель	stal, ZnAl steel, ZnAl сталь, ZnAl



Zawias hydrauliczny mini CIHC, bliźniaczy
 Hydraulic hinge mini CIHC, twin overlay door
 Гидравлическая петля мини CIHC, полунакладная

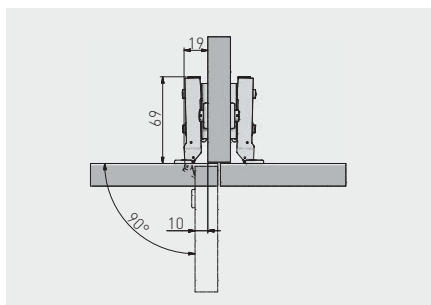

ZP-CIHC080ZE	H = 0	-	x 2	nikiel nickel нικель	stal, ZnAl steel, ZnAl сталь, ZnAl



Zawias hydrauliczny mini CIHC, wpuszczany
 Hydraulic hinge mini CIHC, inset door
 Гидравлическая петля мини CIHC, внутренняя

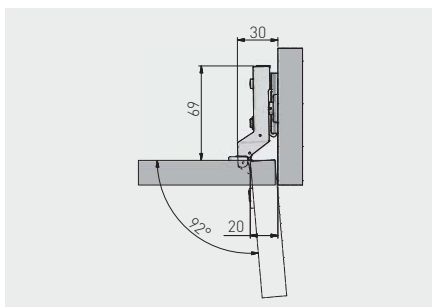

ZP-CIHC070ZE	H = 0	-	x 2	nikiel nickel нικель	stal, ZnAl steel, ZnAl сталь, ZnAl

Zawias mini CIBI, nakładany
 Hinge mini CIBI, overlay door
 Петля мини CIBI, накладная

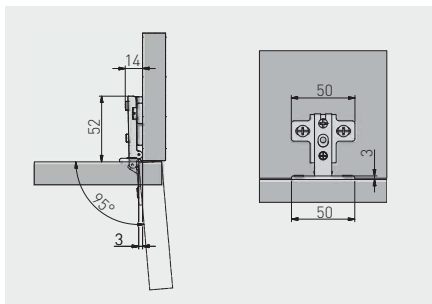

ZP-CIBI9H0ZE	H = 0	-	x 2	nikiel nickel нικель	stal steel сталь

Zawias mini CIBI, bliźniaczy
Hinge mini CIBI, twin overlay door
Петля мини CIBI, полунакладная

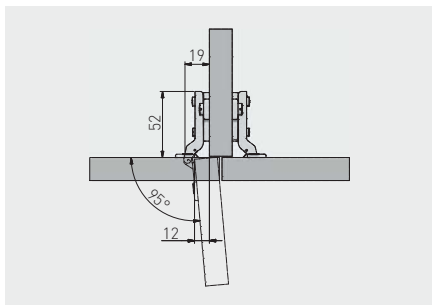

ZP-CIBI8H0ZE	H = 0	-	x 2	nikiel nickel никель	stal steel сталь



Zawias mini CIBI, wpuszczany
Hinge mini CIBI, inset door
Петля мини CIBI, внутренняя

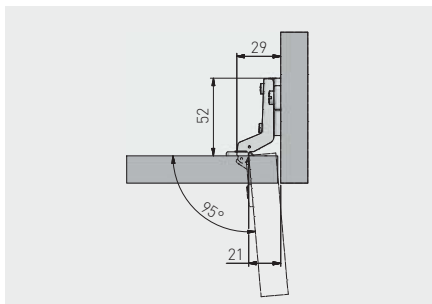

ZP-CIBI7H0ZE	H = 0	-	x 2	nikiel nickel никель	stal steel сталь



Zawias do szkła CIG, nakładany
 Hinge for glass CIG, overlay door
 Петля для стеклянных дверей CIG, накладная

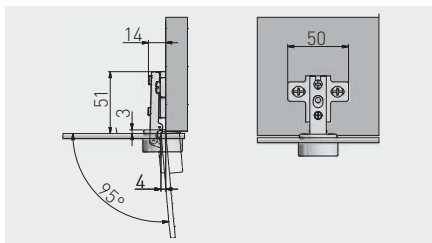

ZP-CIG-09OZE	H = 0	—	x 2	nikiel nickel ннкль	stal, tworzywo steel, plastic сталь, пластмасса		chrom chrome хром
ZP-CIG-09UZE		—	x 2				
ZP-CIG-09UBE		—	—				czarny / black / чёрный
ZP-CIG-09UZC		—	x 2				
ZP-CIG-19OZE		—	x 2				aluminium aluminium алюминий
ZP-CIG-19UZE		—	x 2				



Zawias do szkła CIG, wpuszczany
 Hinge for glass CIG, inset door
 Петля для стеклянных дверей CIG, внутренняя

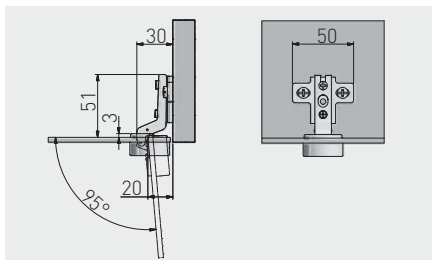

ZP-CIG-07OZE	H = 0	—	x 2	nikiel nickel ннкль	stal, tworzywo steel, plastic сталь, пластмасса		chrom chrome хром
ZP-CIG-07UZE		—	x 2				
ZP-CIG-17OZE		—	x 2				aluminium aluminium алюминий
ZP-CIG-17UZE		—	x 2				



Zawias do ramek aluminiowych, nakładany
 Hinge for aluminium frames, overlay door
 Петля GTV для алюминиевых рамок, с клипом, накладная

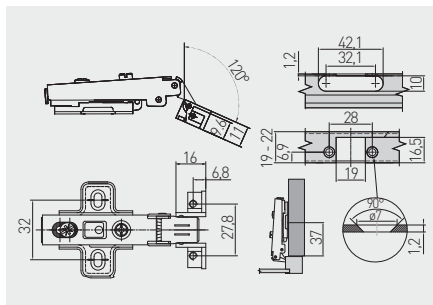

Produkt kompatybilny z profil aluminiowy do frontów: PA-3731-35-50
 Product compatible with aluminum profile for fronts: PA-3731-35-50
 Подходит для алюминиевых профилей под индексом: PA-3731-35-50

ZP-RALUH2-00	H = 2	—	—	nikiel nickel никель	stal steel сталь



Zawias hydrauliczny do ramek aluminiowych, nakładany
 Hinge for aluminium frame, overlay door
 Петля GTV для алюминиевых рамок, с клипом, накладная

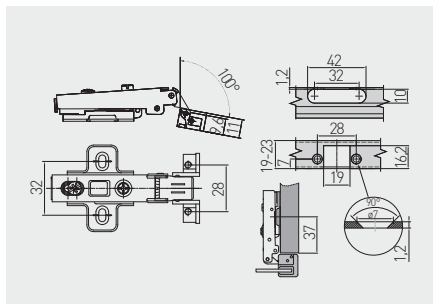

Produkt kompatybilny z profil aluminiowy do frontów: PA-3731-35-50
 Product compatible with aluminum profile for fronts: PA-3731-35-50
 Подходит для алюминиевых профилей под индексом: PA-3731-35-50

ZM-HCRALU9BE	H = 0	—	—	nikiel nickel никель	stal steel сталь



Zawias 270°, nakładany
Hinge 270°, overlay door
Петля 270°, накладная

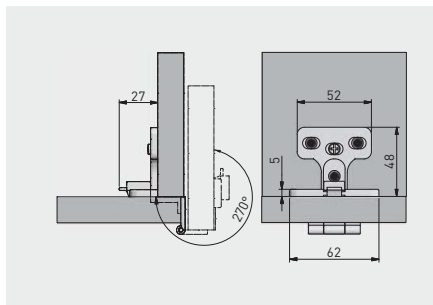

ZP-KT0270-BE	—	—	nikiel nickel ннкль	ZnAl



Zawias tłoczkowy duży
Cylinder hinge large
Поршневая петля (большая)

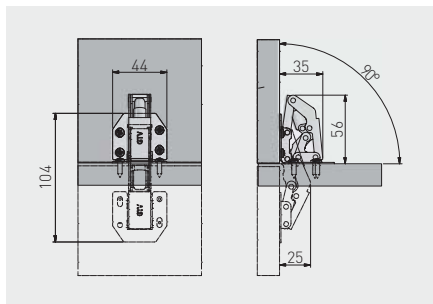

ZT-HF-01-D00	—	—	nikiel nickel ннкль	stal steel сталь



Zawias tłoczkowy mały
 Cylinder hinge small
 Поршневая петля (малая)

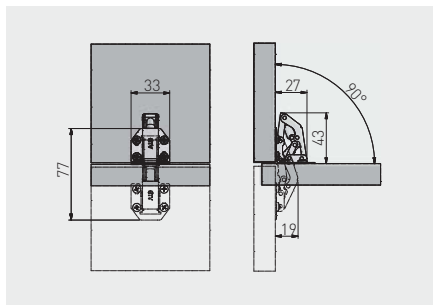

ZT-HF-01-M00	—	—	nikiel nickel никель	stal steel сталь



Zawias JUNIOR 75°
 JUNIOR hinge 75°
 Петля JUNIOR 75°

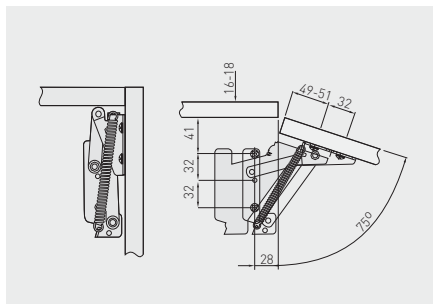

ZP-JUNIOR-00	—	—	nikiel nickel никель	stal steel сталь



Zawias skrzydełkowy
Butterfly hinge
Петля-бабочка

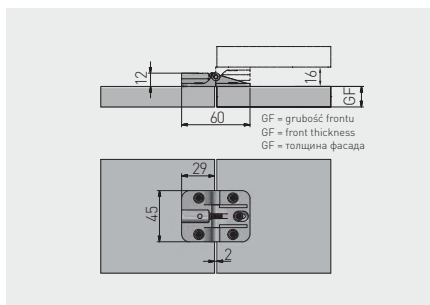

ZP-SKR-00-80	—	—	lakier lacquer лак	szary gray серый	ZnAl



Zawias cylindryczny
Cylinder hinge
Петля цилиндрическая

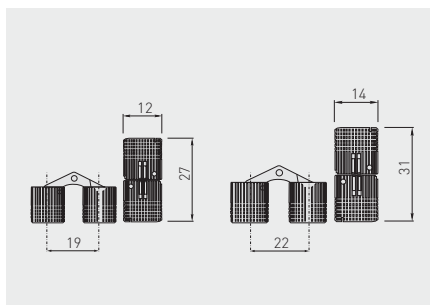

ZC-GTV-12-00	12 mm	7 kg	mosiądz brass латунь	mosiądz brass латунь
ZC-GTV-14-00	14 mm			



Zawias barkowy
Flap hinge
Барная петля

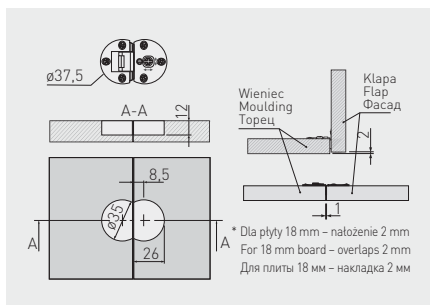

PD-MD-ZB-01-KPL	1 kpl. = 2 szt. 1 set = 2 pcs	chrom / chrome / хром	ZnAl
PD-MD-ZB-04-KPL	1 комп. = 2 шт.	antyczny mosiądz / antique brass / античная латунь	



Amortyzator z adapterem prostym
Buffer with straight adapter
Амортизатор с прямым адаптером

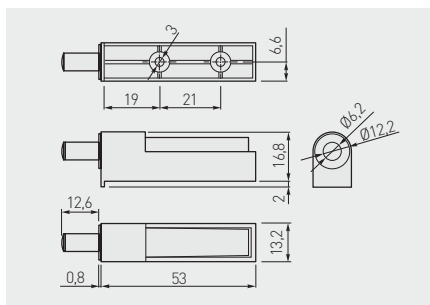

AM-PROST-KPL	szary gray серый	tworzywo plastic пластмасса
--------------	------------------------	-----------------------------------



Amortyzator z adapterem krzyżakowym
 Buffer with cross adapter
 Амортизатор с крестовым адаптером

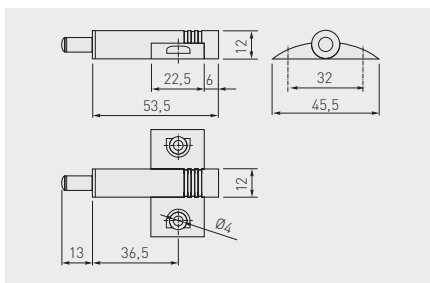

AM-KRZYZ-KPL	szary gray серый	tworzywo plastic пластмасса
--------------	------------------------	-----------------------------------



Amortyzator AM-ODB
 Buffer AM-ODB
 Амортизатор AM-ODB

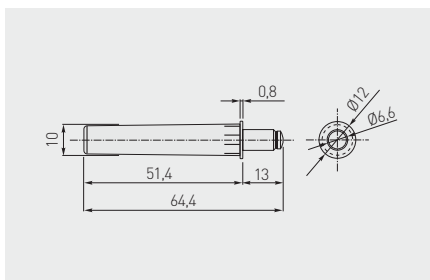

AM-ODB000-60	standard	szary / gray / серый	tworzywo / plastic / пластмасса
AM-ODB000-10		biały / white / белый	



Adapter AM-ODB prosty
 Adapter AM-ODB straight
 Адаптер AM-ODB прямой

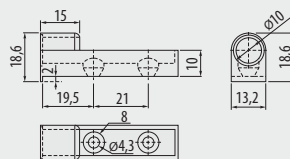

AM-ADAP0B-60	szary / gray / серый	tworzywo / plastic / пластмасса
AM-ADAP0B-10	biały / white / белый	



Adapter AM-ODB krzyżakowy
 Cross adapter AM-ODB
 Адаптер AM-ODB крестовой

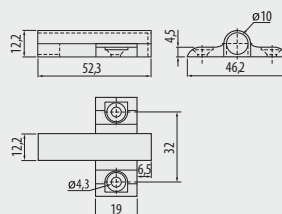

AM-ADAP0A-60	szary / gray / серый	tworzywo / plastic / пластмасса
AM-ADAP0A-10	biały / white / белый	



Odbojnik wpuszczany krótki
Bumper, recessed, short
Амортизатор врезной короткий

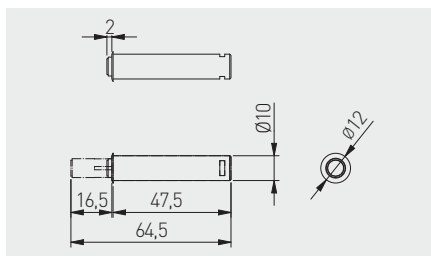

AM-OWM-KR-MG-10	z końcówką magnetyczną / magnetic tip / магнитный наконечник	biały white белый	tworzywo plastic пластмасса
AM-OWM-KR-GM-10	z końcówką kauczukową / with rubber tip / каучуковый наконечник		
AM-OWM-KR-MG-30	z końcówką magnetyczną / magnetic tip / магнитный наконечник	szary gray серый	
AM-OWM-KR-GM-30	z końcówką kauczukową / with rubber tip / каучуковый наконечник		
AM-OWM-KR-MG-60	z końcówką magnetyczną / magnetic tip / магнитный наконечник	antracyt anthracite антрацит	
AM-OWM-KR-GM-60	z końcówką kauczukową / with rubber tip / каучуковый наконечник		



Odbojnik wpuszczany długi
Bumper, recessed, long
Амортизатор врезной длинный

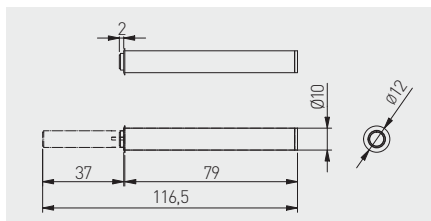

AM-OWM-DL-MG-10	z końcówką magnetyczną / magnetic tip / магнитный наконечник	biały white белый	tworzywo plastic пластмасса
AM-OWM-DL-GM-10	z końcówką kauczukową / with rubber tip / каучуковый наконечник		
AM-OWM-DL-MG-30	z końcówką magnetyczną / magnetic tip / магнитный наконечник	szary gray серый	
AM-OWM-DL-GM-30	z końcówką kauczukową / with rubber tip / каучуковый наконечник		
AM-OWM-DL-MG-60	z końcówką magnetyczną / magnetic tip / магнитный наконечник	antracyt anthracite антрацит	
AM-OWM-DL-GM-60	z końcówką kauczukową / with rubber tip / каучуковый наконечник		



Odbojnik AM-PL z adapterem
Bumper with adapter AM-PL
Амортизатор с адаптером AM-PL

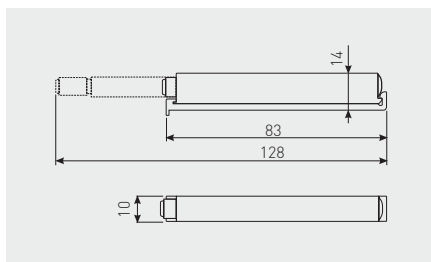

AM-PL-DL-MAG	z końcówką magnetyczną magnetic tip магнитный наконечник	szary gray серый	tworzywo plastic пластмасса
AM-PLA-DLU-0	z końcówką kauczukową with rubber tip каучуковый наконечник		



Odbojnik AM-ZAT zatrzaskowy
Push latch AM-ZAT
Амортизатор AM-ZAT на защелке

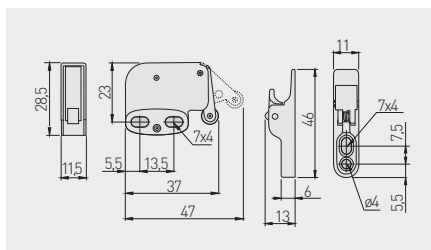

AM-ZAT-A1-10	biały white белый	stal, tworzywo steel, plastic сталь, пластмасса

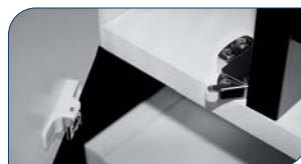

Do zastosowania z zawiasem samootwierającym ZP-POH045ZE0

Dedicated for GTV self opening hinge ZP-POH045ZE0

Используется с самооткрывающейся петлей ZP-POH045ZE0

Odbojnik krótki z adapterem Bumper, short, with adapter Амортизатор короткий с адаптером

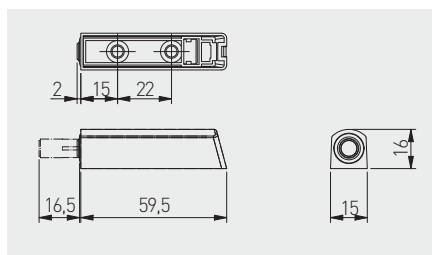

AM-OAM-KR-MG-10	z końcówką magnetyczną / magnetic tip / магнитный наконечник	biały white белый	tworzywo plastic пластмасса
AM-OAM-KR-GM-10	z końcówką kauczukową / with rubber tip / каучуковый наконечник		
AM-OAM-KR-MG-30	z końcówką magnetyczną / magnetic tip / магнитный наконечник	szary gray серый	
AM-OAM-KR-GM-30	z końcówką kauczukową / with rubber tip / каучуковый наконечник		
AM-OAM-KR-MG-60	z końcówką magnetyczną / magnetic tip / магнитный наконечник	antracyt anthracite антрацит	
AM-OAM-KR-GM-60	z końcówką kauczukową / with rubber tip / каучуковый наконечник		



Odbojnik długi z adapterem Bumper, long, with adapter Амортизатор длинный с адаптером

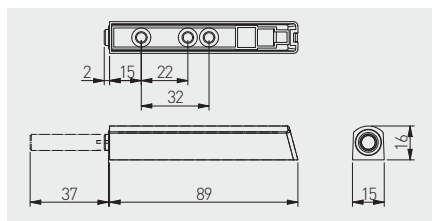



AM-OAM-DL-MG-10	z końcówką magnetyczną / magnetic tip / магнитный наконечник	biały white белый	tworzywo plastic пластмасса
AM-OAM-DL-GM-10	z końcówką kauczukową / with rubber tip / каучуковый наконечник		
AM-OAM-DL-MG-30	z końcówką magnetyczną / magnetic tip / магнитный наконечник	szary gray серый	
AM-OAM-DL-GM-30	z końcówką kauczukową / with rubber tip / каучуковый наконечник		
AM-OAM-DL-MG-60	z końcówką magnetyczną / magnetic tip / магнитный наконечник	antracyt anthracite антрацит	
AM-OAM-DL-GM-60	z końcówką kauczukową / with rubber tip / каучуковый наконечник		



Amortyzator silikonowy
Silicone damper dots
Амортизатор силиконовый







	 mm	
AMR-BP-1003	Ø10 x 3	100 szt. / arkusz 100 psc / sheet 100 шт. / лист
AMR-BP-0715	Ø7 x 1,5	

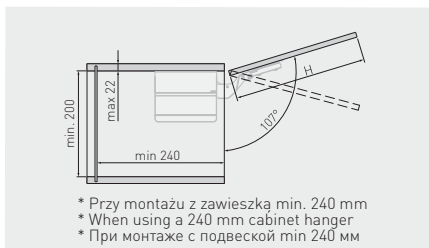

Podnośnik PD-LIFTNEW
PD-LIFTNEW lift
Подъемник PD-LIFTNEW

NEW



	 Orientacyjna wysokość frontu Approximate front height Ориентировочная высота фасада	Współczynnik F Power Factor F Показатель F	Sprężyna Spring power Пружина		
PD-LIFTNEW-LIGHT-10	250 – 400 mm	480 – 1250	light	biały / white / белый szary / gray / серый	stal steel
PD-LIFTNEW-LIGHT-80					
PD-LIFTNEW-MEDIUM-10	250 – 500 mm	960 – 2350	medium	biały / white / белый szary / gray / серый	
PD-LIFTNEW-MEDIUM-80					
PD-LIFTNEW-STRONG-10	250 – 500 mm	1600 – 3600	strong	biały / white / белый szary / gray / серый	
PD-LIFTNEW-STRONG-80					
PD-LIFTNEW-STRONG-PLUS-10	600 mm	2500 – 4500	extra strong	biały / white / белый szary / gray / серый	
PD-LIFTNEW-STRONG-PLUS-80					

Współczynnik mocy F = wysokość frontu H (mm) × waga frontu łącznie z podwójną wagą uchwytu (kg)



Power Factor F = front height × front weight with doubled handle weight (kg)

Показатель мощности F = высота фасада H (мм) × вес фасада с удвоенным весом ручки (кг)

Podnośnik PD-LIFT-P20
PD-LIFT-P20 lift
Подъемник PD-LIFT-P20

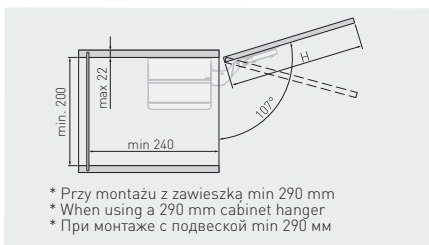
NEW



	 Orientacyjna wysokość frontu Approximate front height Ориентировочная высота фасада	Współczynnik F Power Factor F Показатель F	Sprężyna Spring power Пружина		
PD-LIFT-P20-LIGHT-10	250 – 400 mm	580 – 1350	light	biały / white / белый szary / gray / серый	stal steel
PD-LIFT-P20-LIGHT-80					
PD-LIFT-P20-MEDIUM-10	250 – 500 mm	1060 – 2450	medium	biały / white / белый szary / gray / серый	
PD-LIFT-P20-MEDIUM-80					
PD-LIFT-P20-STRONG-10	250 – 500 mm	1800 – 4000	strong	biały / white / белый szary / gray / серый	
PD-LIFT-P20-STRONG-80					
PD-LIFT-P20-STRONG-PLUS-10	600 mm	2600 – 5000	extra strong	biały / white / белый szary / gray / серый	
PD-LIFT-P20-STRONG-PLUS-80					

Współczynnik mocy F = wysokość frontu H (mm) × waga frontu łącznie z podwójną wagą uchwytu (kg)

Power Factor F = front height H (mm) × front weight with doubled handle weight (kg)

Показатель мощности F = высота фасада H (мм) × вес фасада с удвоенным весом ручки (кг)

Podnośnik gazowy NEO
Gas stay lift NEO
Подъемник газовый NEO

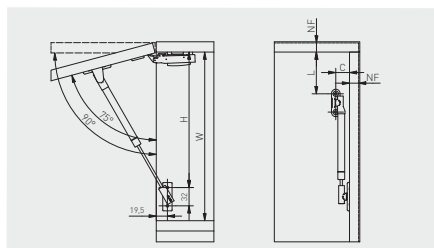

ø 12				
Kąt otwarcia drzwi Door opening angle Угол открывания дверей	H (mm)	L (mm)	C (mm)	W (mm)
75°	237	73	24	275
90°	217	54		
ø 15				
Kąt otwarcia drzwi Door opening angle Угол открывания дверей	H (mm)	L (mm)	C (mm)	W (mm)
75°	247	73	24	295
90°	228	52		

Model	Force (N)	Color	Material
PD-GNE012-50-60	50 N	szary / antracyt gray / anthracite серый / антрацит	stal steel сталь
PD-GNE012-60-60	60 N		
PD-GNE012-80-60	80 N		
PD-GNE015-100-60	100 N		
PD-GNE015-120-60	120 N		
PD-GNE015-150-60	150 N		
PD-GNE012-50-10M	50 N	biały white белый	
PD-GNE012-60-10M	60 N		
PD-GNE012-80-10M	80 N		
PD-GNE015-100-10M	100 N		
PD-GNE015-120-10M	120 N		
PD-GNE015-150-10M	150 N		
PD-GNE015-50-60	50 N	szary / antracyt gray / anthracite серый / антрацит	
PD-GNE015-60-60	60 N		
PD-GNE015-80-60	80 N		
PD-GNE015-50-10M	50 N	biały white белый	
PD-GNE015-60-10M	60 N		
PD-GNE015-80-10M	80 N		

Kąt otwarcia drzwi Door opening angle Угол открывания дверей	Siła podnośnika Lift force Мощность подъемника	Wysokość drzwi (mm) / Door height (mm) / Высота дверцы (мм)			
		300	400	500	600
		Waga drzwi (kg) / Door weight (kg) / Вес дверцы (кг)			
75°	50 N	1,6	1,2	1,0	0,8
	60 N	2,0	1,5	1,2	1,0
	80 N	2,7	2,0	1,6	1,4
	100 N	3,4	2,6	2,0	1,7
	120 N	4,1	3,1	2,5	2,0
90°	150 N	4,7	3,5	2,9	2,4
	50 N	1,5	1,1	0,9	0,7
	60 N	1,8	1,3	1,1	0,9
	80 N	2,4	1,8	1,4	1,2
	100 N	3,0	2,2	1,8	1,5
100°	120 N	3,6	2,7	2,1	1,8
	150 N	4,1	3,2	2,3	2,1
	50 N	1,1	1,0	0,8	0,7
	60 N	1,6	1,2	0,9	0,8
	80 N	2,1	1,6	1,2	1,0
100°	100 N	2,6	1,9	1,6	1,3
	120 N	3,1	2,3	1,9	1,6
	150 N	3,5	2,6	2,2	1,9

Podnośnik gazowy z amortyzatorem i regulacją
 Gas stay with buffer, adjustable
 Подъемник газовый с амортизатором и регулировкой

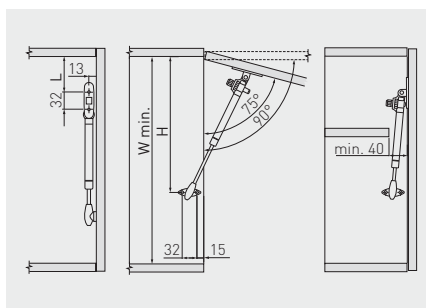

PD-GAM050-N02	50 N	szary gray серый	stal steel сталь
PD-GAM060-N02	60 N		
PD-GAM080-N02	80 N		
PD-GAM100-N02	100 N		
PD-GAM120-N02	120 N		
PD-GAM050-N10	50 N	biały white белый	
PD-GAM060-N10	60 N		
PD-GAM080-N10	80 N		
PD-GAM100-N10	100 N		
PD-GAM120-N10	120 N		
PD-GAM050-N60	50 N	antracyt anthracite антрацит	
PD-GAM060-N60	60 N		
PD-GAM080-N60	80 N		
PD-GAM100-N60	100 N		
PD-GAM120-N60	120 N		
PD-GAM150-N60	150 N		

Kąt otwarcia drzwi Door opening angle Угол открывания дверей	H (mm)	L (mm)	W (mm)
75°	295	64	315
90°	275	52	300



Kąt otwarcia drzwi Door opening angle Угол открывания дверей	Siła podnośnika Lift force Мощность подъемника	Wysokość drzwi (mm) / Door height (mm) / Высота дверцы (мм)			
		300	400	500	600
		Waga drzwi (kg) / Door weight (kg) / Вес дверцы (кг)			
<p>75°</p>	50 N	1,6	1,2	1,0	0,8
	60 N	2,0	1,5	1,2	1,0
	80 N	2,7	2,0	1,6	1,4
	100 N	3,4	2,6	2,0	1,7
	120 N	4,1	3,1	2,5	2,0
<p>90°</p>	50 N	1,5	1,1	0,9	0,7
	60 N	1,8	1,3	1,1	0,9
	80 N	2,4	1,8	1,4	1,2
	100 N	3,0	2,2	1,8	1,5
	120 N	3,6	2,7	2,1	1,8
	150 N	4,1	3,2	2,3	2,1

Podnośnik gazowy standard
Gas stay lift standard
Подъемник газовый стандартный

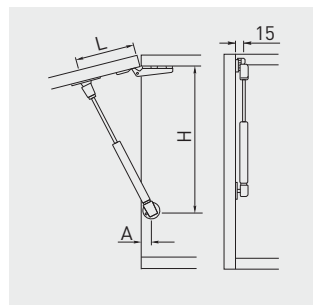

PD-G0050-N02	50 N	szary gray серый	stal steel сталь
PD-G0060-N02	60 N		
PD-G0080-N02	80 N		
PD-G0100-N02	100 N		
PD-G0120-N02	120 N		
PD-G0150-N02	150 N		



Kąt otwarcia drzwi Door opening angle Угол открывания дверей	Drzwi wpuszczone Inset door Внутренние двери			Drzwi bliźniacze Twin door Двойные двери			Drzwi nakładane Overlay door Наружные двери		
	H (mm)	L (mm)	A (mm)	H (mm)	L (mm)	A (mm)	H (mm)	L (mm)	A (mm)
75°	280	100	20 + grubość frontu 20 + front thicknes 20 + толщина фронта	272	100	25	264	100	25
90°	260	90		251	90	25	244	90	25
100°	250	80		242	80	25	234	80	25

Kąt otwarcia drzwi Door opening angle Угол открывания дверей	Siła podnośnika Lift force Мощность подъемника	Wysokość drzwi (mm) / Door height (mm) / Высота двери (мм)			
		300	400	500	600
Waga drzwi (kg) / Door weight (kg) / Вес двери (кг)					
75°	60 N	2,0	1,5	1,2	1,0
	80 N	2,7	2,0	1,6	1,4
	100 N	3,4	2,6	2,0	1,7
	120 N	4,1	3,1	2,5	2,0
	150 N	4,7	3,5	2,9	2,4
90°	60 N	1,8	1,3	1,1	0,9
	80 N	2,4	1,8	1,4	1,2
	100 N	3,0	2,2	1,8	1,5
	120 N	3,6	2,7	2,1	1,8
	150 N	4,1	3,2	2,3	2,1
100°	60 N	1,6	1,2	0,9	0,8
	80 N	2,1	1,6	1,2	1,0
	100 N	2,6	1,9	1,6	1,3
	120 N	3,1	2,3	1,9	1,6
	150 N	3,5	2,6	2,2	1,9

Podnośnik gazowy krótki
Gas stay lift short
Подъемник газовый короткий

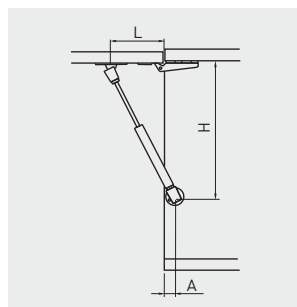

PD-G60160-02	60 N	szary gray серый	stal steel сталь
PD-G80160-02	80 N		



Kąt otwarcia drzwi Door opening angle Угол открывания дверей	Drzwi wpuszczane Inset door Внутренние дверцы			Drzwi bliźniacze Twin door Двойные дверцы			Drzwi nakładane Overlay door Наружные дверцы		
	H (mm)	L (mm)	A (mm)	H (mm)	L (mm)	A (mm)	H (mm)	L (mm)	A (mm)
75°	188	70	20 + grubość frontu 20 + front thickness 20 + толщина фронта	180	70	20	172	70	20
90°	176	60		167	60	20	160	60	20
100°	172	50		164	50	20	154	50	20

Kąt otwarcia drzwi Door opening angle Угол открывания дверей	Siła podnośnika Lift force Мощность подъемника	Wysokość drzwi (mm) / Door height (mm) / Высота дверцы (мм)			
		300	400	500	600
		Waga drzwi (kg) / Door weight (kg) / Вес дверцы (кг)			
75° 	60 N	2,0	1,5	1,2	1,0
	80 N	2,7	2,0	1,6	1,4
90° 	60 N	1,8	1,3	1,1	0,9
	80 N	2,4	1,8	1,4	1,2
100° 	60 N	1,6	1,2	0,9	0,8
	80 N	2,1	1,6	1,2	1,0

Podnośnik DESIGN mechaniczny
 Mechanical stay lift DESIGN
 Подъемник механический DESIGN



PD-GPD01-001	chrom / chrome / хром	stal steel сталь
PD-GPD02-002	satyna / satin / сатин	
PD-GPD03-005	aluminium / алюминий	



Podnośnik do klap
 Flap lift
 Подъемник фасада



100°

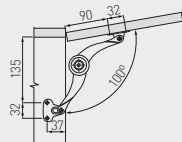

Płaszczyzna wewn. boku
 Inner side surface
 Поверхность боковой стенки

Podnośnik do klap
 Flap lift
 Подъемник фасада



75°

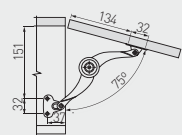

Płaszczyzna wewn. boku
 Inner side surface
 Поверхность боковой стенки

Podnośnik do klap
 Flap lift
 Подъемник фасада



90°

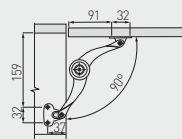

Płaszczyzna wewn. boku
 Inner side surface
 Поверхность боковой стенки

Wizualizacja dla zawiasów barkowych
 Drop Down Flap Stay
 Визуализация для барных петель



90°

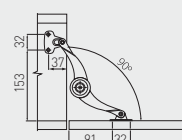

Płaszczyzna wewn. boku
 Inner side surface
 Поверхность боковой стенки

Wykres orientacyjnych wartości
 maksymalnego ciężaru w zależności
 od wysokości klapy.

Maximum weight depending
 on the flap height.

Максимальный вес фасада зависит
 от его высоты.

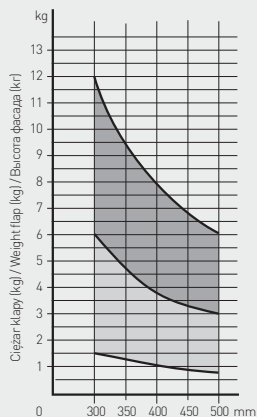
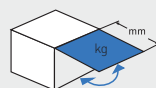

Wysokość klapy (mm)
 Flap height (mm)
 Высота фасада (мм)

- 1 podnośnik
1 stay lift
1 подъемник
- 2 podnośniki
2 stay lifts
2 подъемника

Podnośnik mechaniczny standard
 Mechanical stay lift standard
 Подъемник механический стандартный



PD-PD000-001



chrom / chrome / хром



stal / steel / сталь



Podnośnik do klap
 Flap lift
 Поддержка фасада



100°

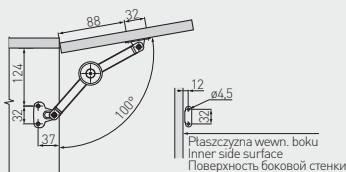

Wykres orientacyjnych wartości maksymalnego ciężaru w zależności od wysokości kłapy.

Maximum weight depending on the flap height.

Максимальный вес фасада зависит от его высоты.

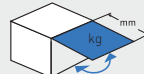

Podnośnik do klap
 Flap lift
 Поддержка фасада



75°

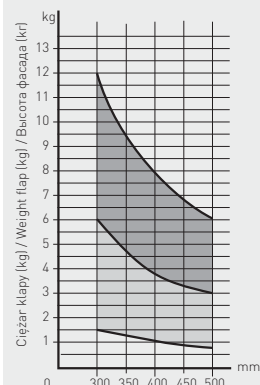
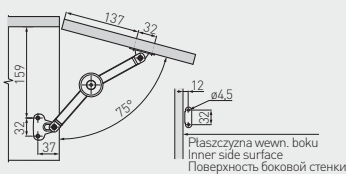

Podnośnik do klap
 Flap lift
 Поддержка фасада



90°

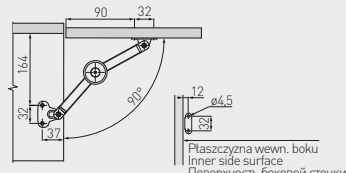

Rozwórka do klap
 Wizualizacja dla zawiasu barkowego
 Drop down flap stay
 Поддержка фасада
 Визуализация для барных петель



90°

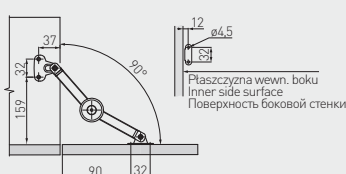

Wysokość kłapy (mm)
 Flap height (mm)
 Высота фасада (мм)

- 1 podnośnik
1 stay lift
1 подъемник
- 2 podnośniki
2 stay lifts
2 подъемника

Amortyzator VIM do klap barkowych, krótki
 VIM stay lift for drop down cabinet doors, short
 Амортизатор барный, короткий VIM



Produkt kompatybilny z zawiasem barkowym: PD-MD-ZB
 Compatible with flap hinge: PD-MD-ZB

Продукт совместим с барной петлей: PD-MD-ZB

		
PD-MDLIFT-P1-D	szary gray серый	stal steel сталь



Orientacyjna tabela wartości doboru podnośników, w zależności od szerokości i wysokości kłapy.
 Maximum weight depending on the flap height.
 Таблица подбора амортизатора в зависимости от ширины и высоты фасада.

Wysokość Height Высота	Szerokość (mm) / Width (mm) / Ширина (мм)			
	600 mm	700 mm	800 mm	900 mm
Ilość amortyzatorów Number of lifts Количество амортизаторов				
250 mm	1	1	2	2
260 mm				
270 mm				
280 mm				
290 mm	2	2	2	2
300 mm				
310 mm				
320 mm				
330 mm				
340 mm				

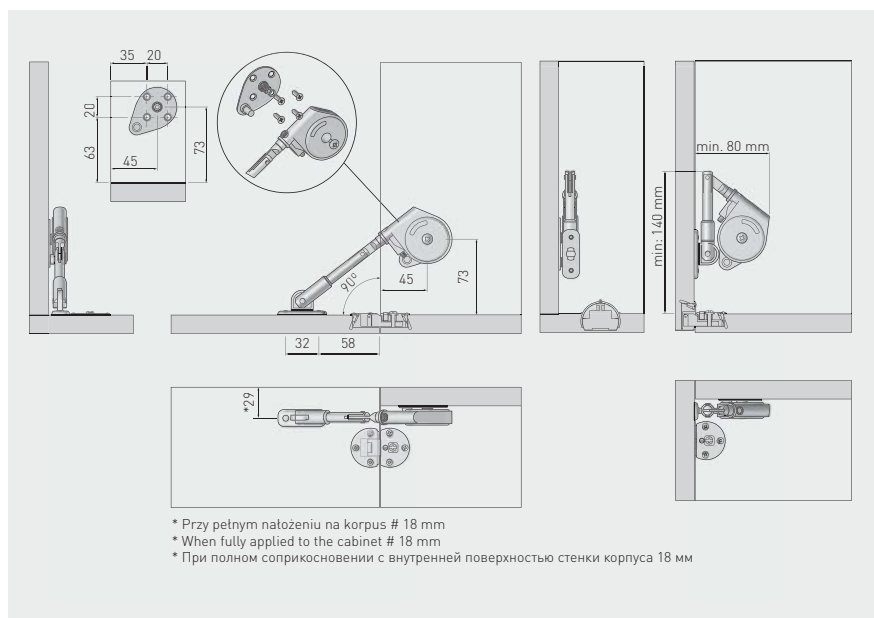

Amortyzator VIM do klap barkowych, długi
 VIM stay lift for drop down cabinet doors, long
 Амортизатор барный VIM, длинный



Produkt kompatybilny z zawiasem barkowym: PD-MD-ZB
 Compatible with flap hinge: PD-MD-ZB

Продукт совместим с барной петлей: PD-MD-ZB

		
PD-MDLIFT-P2-D	szary gray серый	stal steel сталь





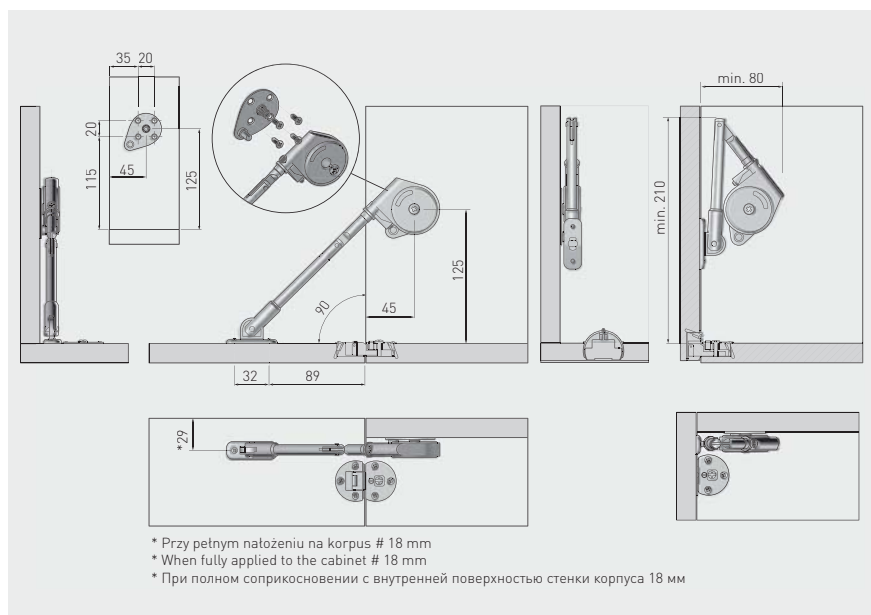

Orientacyjna tabela wartości doboru podnośników, w zależności od szerokości i wysokości kłapy.
 Maximum weight depending on the flap height.
 Таблица подбора амортизатора в зависимости от ширины и высоты фасада.

Wysokość Height Высота	Szerokość (mm) / Width (mm) / Ширина (мм)			
	600 mm	700 mm	800 mm	900 mm
350 mm	Ilość amortyzatorów Number of lifts Количество амортизаторов			
360 mm	1	2	2	2
370 mm				
380 mm				
390 mm				
400 mm				

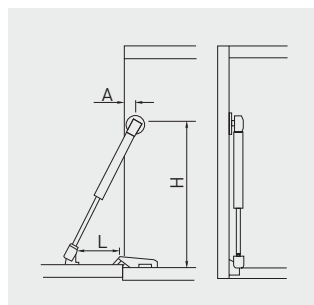

Amortyzator olejowy do klap barkowych
Oil stay lift for drop down cabinet doors
Амортизатор маслянный барный



			
PD-ECGDL-060	60 N	szary gray серый	stal steel сталь
PD-ECGDL-080	80 N		
PD-ECGDL-150	150 N		

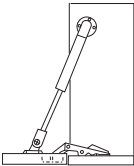

Kąt otwarcia drzwi Door opening angle Угол открывания дверей	Drzwi wpuszczane Inset door Внутренние дверцы			Drzwi bliźniacze Twin door Двойные дверцы			Drzwi nakładane Overlay door Наружные дверцы		
	H (mm)	L (mm)	A (mm)	H (mm)	L (mm)	A (mm)	H (mm)	L (mm)	A (mm)
90°	260	90	45	253	90	25	246	90	25

Kąt otwarcia drzwi Door opening angle Угол открывания дверей	Siła podnośnika Lift force Мощность подъемника	Wysokość drzwi (mm) / Door height (mm) / Высота дверцы (мм)			
		300	400	500	600
		Waga drzwi (kg) / Door weight (kg) / Вес дверцы (кг)			
 90°	60 N	1,8	1,3	1,1	0,9
	80 N	2,4	1,8	1,4	1,2
	150 N	4,1	3,2	2,3	2,1

Prowadnica dolnego montażu ze spowalniczem 0SHX
 Undermount drawer slide with soft closing 0SHX
 Направляющая нижнего монтажа полного выдвижения с доводчиком 0SHX



Rozstaw otworów montażowych
 Mounting dimensions
 Монтажные отверстия

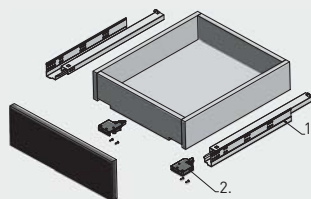
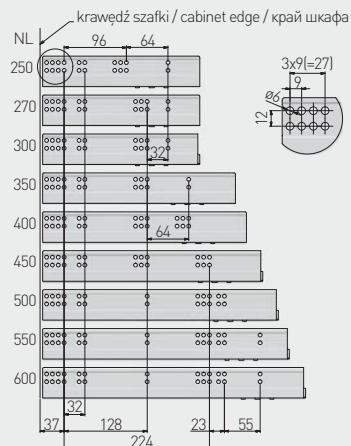

1. prowadnica lewa/prawa
 drawer slide L/R
 направляющая Л/П
2. sprzęgło lewe/prawe + wkręty
 locking device L/R + screws
 крепления фасада Л/П + саморезы

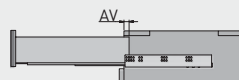

NL = długość nominalna prowadnicy
 nominal slide length
 номинальная длина направляющей

AV = strata wysuwu
 extension loss
 потеря на выдвижении

Uwagi montażowe: dla prawidłowego działania szuflady jej szerokość nie może przekraczać długości nominalnej prowadnicy.
 Mounting information: for proper drawer operation, the width of the drawer can not exceed the nominal slide length.
 Техническое примечание: ширина ящика не должна превышать длину направляющей.

	NL mm	AV mm		kg		
PB-0SHX-250-A	250	16	pełny full полное	35		stal steel сталь
PB-0SHX-270-A	270					
PB-0SHX-300-A	300					
PB-0SHX-350-A	350					
PB-0SHX-400-A	400					
PB-0SHX-450-A	450					
PB-0SHX-500-A	500					
PB-0SHX-550-A	550					
PB-0SHX-600-A	600					



Prowadnica dolnego montażu ze spowalniczem 0SHX-18 3D
 Undermount drawer slide with soft closing 0SHX-18 3D
 Направляющая нижнего монтажа с доводчиком 0SHX-18 3D



NL krawędź szafki / cabinet edge / край шкафа

3x9(=27)
9
12

1. prowadnica lewa/prawa drawer slide L/R направляющая Л/П
2. sprzętko lewe/prawe + wkręty locking device L/R + screws крепления фасада Л/П + саморезы

AV

NL = długość nominalna prowadnicy nominal slide length
 номинальная длина направляющей
 AV = strata wysuwu extension loss
 потеря на выдвигании

Uwagi montażowe: dla prawidłowego działania szuflady jej szerokość nie może przekraczać długości nominalnej prowadnicy.
 Mounting information: for proper drawer operation, the width of the drawer can not exceed the nominal slide length.
 Техническое примечание: ширина ящика не должна превышать длину направляющей.

	L mm	AV mm		kg		
PB-3D0SHX18-300-H	300	16	pełny full полное	30	ocynk galvanized гальваника	stal steel сталь
PB-3D0SHX18-350-H	350					
PB-3D0SHX18-400-H	400					
PB-3D0SHX18-450-H	450					
PB-3D0SHX18-500-H	500					
PB-3D0SHX18-550-H	550					



Prowadnica dolnego montażu ze spowalniaczem GCHX-H

Undermount drawer slide with soft closing GCHX-H

Направляющая нижнего монтажа неполное выдвигание с доводчиком GCHX-H

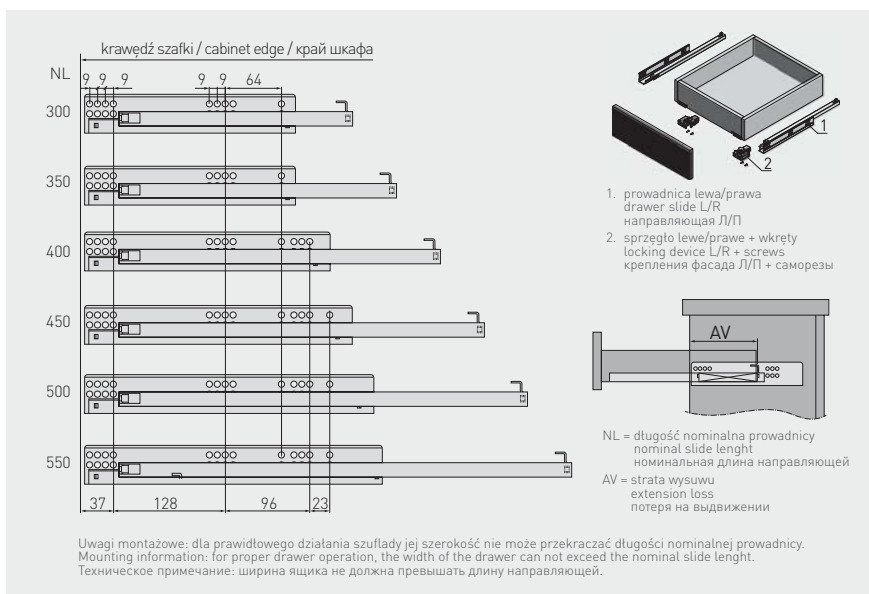

	L mm	AV mm		kg		
PB-GCHX-300-H	300	83	niepełny partial неполное	30	ocynk galvanized гальваника	stal steel сталь
PB-GCHX-350-H	350					
PB-GCHX-400-H	400					
PB-GCHX-450-H	450	111				
PB-GCHX-500-H	500					
PB-GCHX-550-H	550					







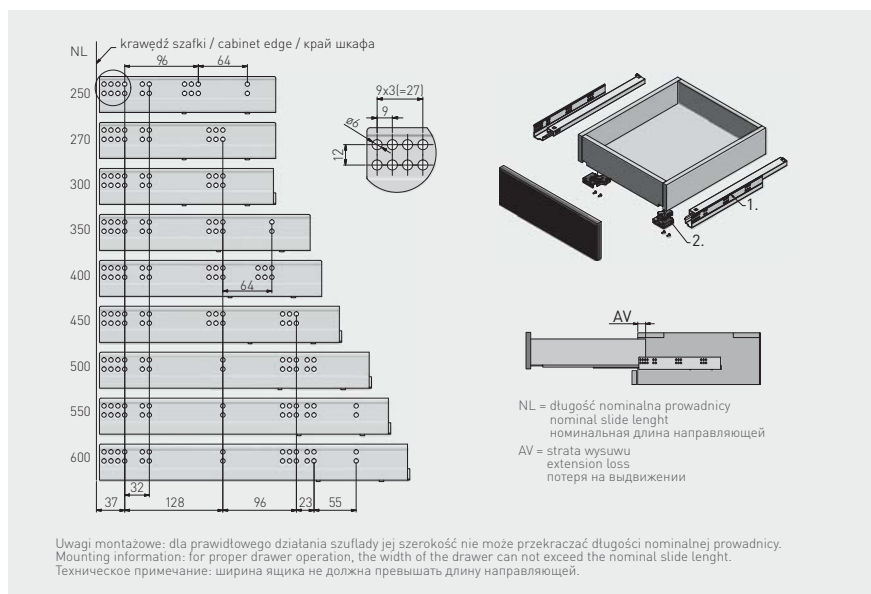

Prowadnica dolnego montażu push to open 0FPO
 Undermount drawer slide push to open 0FPO
 Направляющая нижнего монтажа push to open 0FPO



Możliwość zastosowania stabilizatora
 PB-D-P20STAB
 Can be used with stabilizer
 PB-D-P20STAB
 Возможность использования
 стабилизатора
 PB-D-P20STAB



		 L mm	 AV mm		 kg 1		
PB-0FPO-250		250	26	pełny full полное	25	ocynk galvanized гальванка	stal steel сталь
PB-0FPO-270		270					
PB-0FPO-300		300					
PB-0FPO-350		350					
PB-0FPO-400		400					
PB-0FPO-450		450					
PB-0FPO-500		500					
PB-0FPO-550		550					
PB-0FPO-600		600					



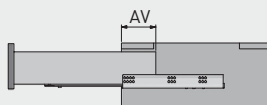
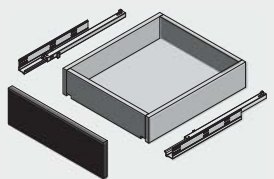
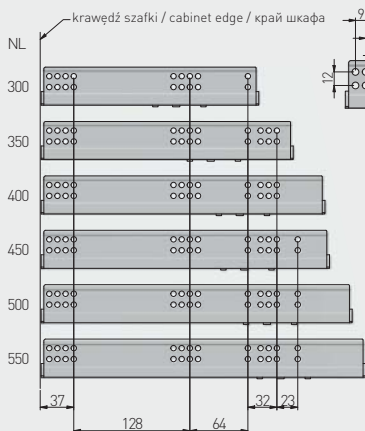

Prowadnice dolnego montażu ze spowalniczem G10HX-H
 Undermount drawer slide with soft closing G10HX-H
 Направляющая нижнего монтажа неполное выдвигание с доводчиком G10HX-H



NL = długość nominalna prowadnicy
 nominal slide length
 номинальная длина направляющей
 AV = strata wysuwu
 extension loss
 потеря на выдвигании

Uwagi montażowe: dla prawidłowego działania szuflady jej szerokość nie może przekraczać długości nominalnej prowadnicy.
 Mounting information: for proper drawer operation, the width of the drawer can not exceed the nominal slide length.
 Техническое примечание: ширина ящика не должна превышать длину направляющей.

		 L mm	 AV mm				
PB-G10HX300-H		300	83	niepełny partial неполное	25	ocynk galvanized гальваника	stal steel сталь
PB-G10HX350-H		350					
PB-G10HX450-H		450	111				
PB-G10HX500-H		500					
PB-G10HX550-H		550					



Prowadnica kulkowa H53
 Ball bearing slide H53
 Шариковая направляющая H53

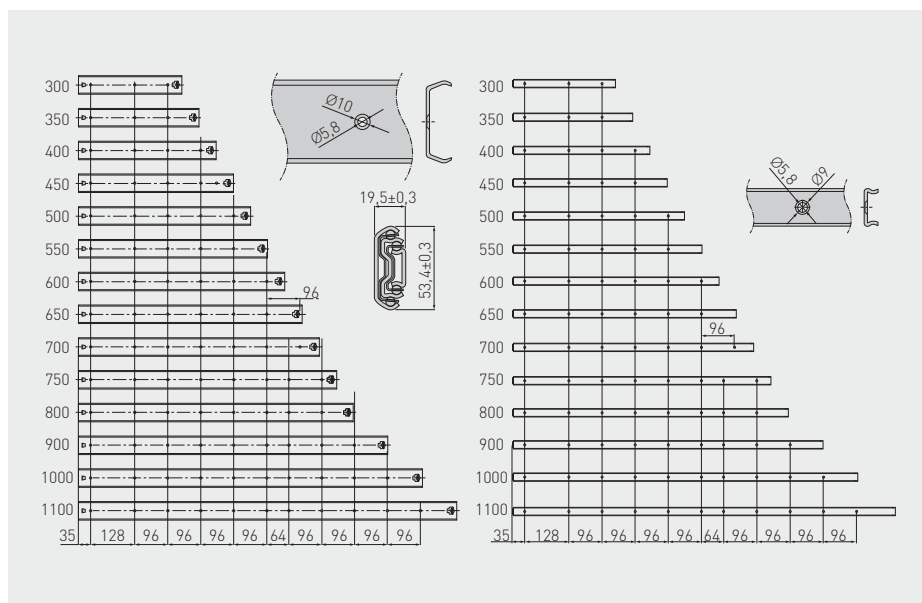

	L mm	AV mm	kg		
PK-0-H53-300	300	-	100	ocynk galvanized гальваника	stal steel сталь
PK-0-H53-350	350	-			
PK-0-H53-400	400	-			
PK-0-H53-450	450	-			
PK-0-H53-500	500	-			
PK-0-H53-550	550	-			
PK-0-H53-600	600	-			

	L mm	AV mm	kg		
PK-0-H53-650	650	-	100	ocynk galvanized гальваника	stal steel сталь
PK-0-H53-700	700	-			
PK-0-H53-750	750	-			
PK-0-H53-800	800	-			
PK-0-H53-900	900	-			
PK-0-H53-1000	1000	-			
PK-0-H53-1100	1100	-			



Prowadnica kulkowa VERSALITE PRO H45 push to open i soft close
 Ball bearing slide VERSALITE PRO H45 push to open & soft close
 Шариковая направляющая VERSALITE PRO H45 push to open с soft close

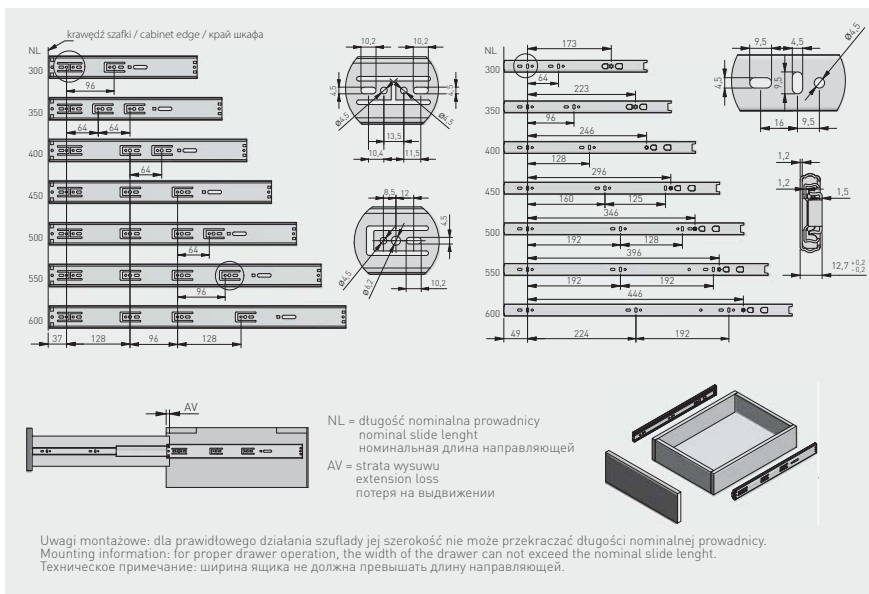

	L mm	AV mm		kg		
PK-L-P20-H45-300	300	52	pełny full полное	30	osynek galvanized гальваника	stal steel сталь
PK-L-P20-H45-350	350	35				
PK-L-P20-H45-400	400	20				
PK-L-P20-H45-450	450	4				
PK-L-P20-H45-500	500					
PK-L-P20-H45-550	550					
PK-L-P20-H45-600	600					





Prowadnica kulkowa VERSALITE PLUS ze spowalniczem H45
 Ball bearing slide VERSALITE PLUS with soft closing H45
 Шариковая направляющая VERSALITE PLUS с доводчиком H45





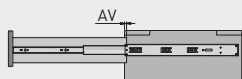
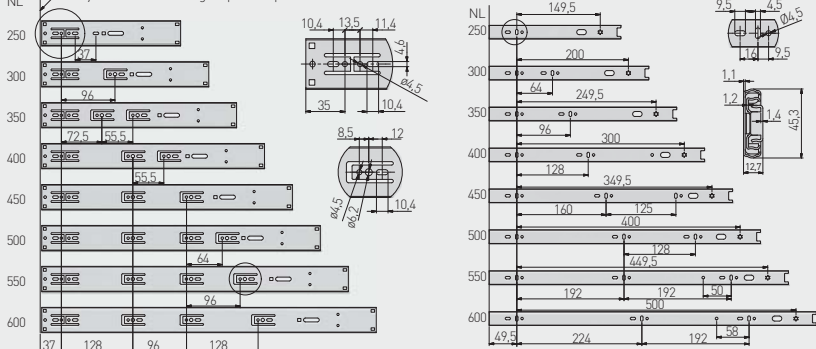

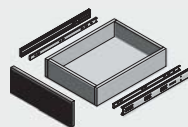

NL - krawędź szafki / cabinet edge / край шкафа



NL = długość nominalna prowadnicy
 nominal slide length
 номинальная длина направляющей
 AV = strata wysuwu
 extension loss
 потеря на выдвигении



Uwagi montażowe: dla prawidłowego działania szuflady jej szerokość nie może przekraczać długości nominalnej prowadnicy.
 Mounting information: for proper drawer operation, the width of the drawer can not exceed the nominal slide length.
 Техническое примечание: ширина ящика не должна превышать длину направляющей.

	 L mm	 AV mm		 kg		
PK-L-H45-250	250*	102	petny full полное	30	ocynk galvanized гальваника	stal steel сталь
PK-L-H45-300	300*	52				
PK-L-H45-350	350*	35				
PK-L-H45-400	400*	20				
PK-L-H45-450	450	4				
PK-L-H45-500	500					
PK-L-H45-550	550					
PK-L-H45-600	600					



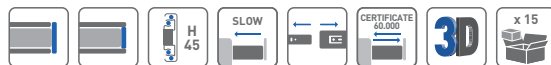



* Brak pełnego wysuwu / Not full extension / Неполное выдвигение

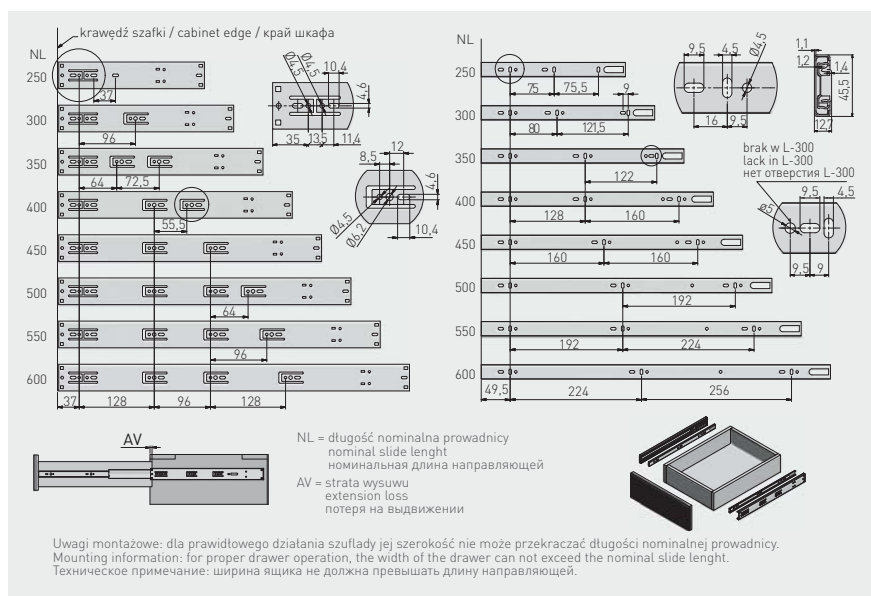



Prowadnica kulkowa VERSALITE ze spowalniczem H45*
 Ball bearing slide VERSALITE with soft closing H45*
 Шариковая направляющая VERSALITE с доводчиком H45*



		 L mm	 AV mm		 kg		
PK-L-H45-250-A		250**	55	pełny full полное	30	ocynk galvanized гальваника	stal steel сталь
PK-L-H45-300-A		300	15				
PK-L-H45-350-A		350	5				
PK-L-H45-400-A		400	5				
PK-L-H45-450-A		450	5				
PK-L-H45-500-A		500	5				
PK-L-H45-550-A		550	0				
PK-L-H45-600-A		600	0				

*Produkt dostępny na indywidualne zamówienie / Available for special orders / Товар доступен под заказ

** Brak pełnego wysuwu / Not full extension / Неполное выдвижение



Prowadnica kulkowa VERSALITE LIGHT ze spawalniczem H45
 Ball bearing slide VERSALITE LIGHT with soft closing H45
 Шариковая направляющая VERSALITE LIGHT с доводчиком H45









NL krawędź szafki / cabinet edge / край шкафа

NL = długość nominalna prowadnicy
 nominal slide length
 номинальная длина направляющей

AV = strata wysuwu
 extension loss
 потеря на выдвигении

Uwagi montażowe: dla prawidłowego działania szuflady jej szerokość nie może przekraczać długości nominalnej prowadnicy.
 Mounting information: for proper drawer operation, the width of the drawer can not exceed the nominal slide length.
 Техническое примечание: ширина ящика не должна превышать длину направляющей.





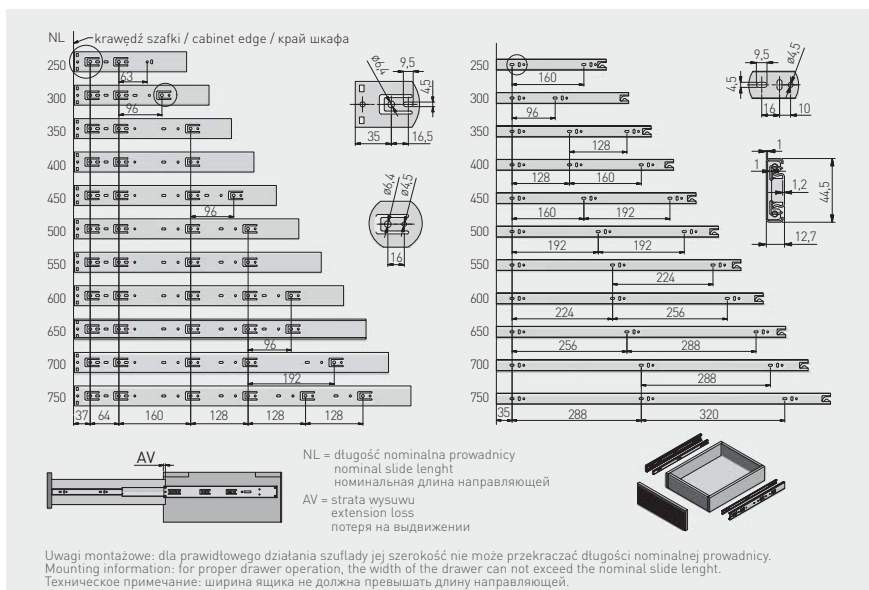

		 L mm	 AV mm		 kg		
	PK-L-H45-300-GX	300*	50	pełny full полное	25	ocynk galvanized гальваника	stal steel сталь
	PK-L-H45-350-GX	350	20				
	PK-L-H45-400-GX	400	-				
	PK-L-H45-450-GX	450	-				
	PK-L-H45-500-GX	500	-				
	PK-L-H45-550-GX	550	-				
	PK-L-H45-600-GX	600	-				

* Brak pełnego wysuwu / Not full extension / Неполное выдвижение



Prowadnica kulkowa z samodociąganiem H45
 Ball bearing slide with self closing H45
 Шариковая направляющая с фиксатором H45



		 L mm	 AV mm				
PK-S-H45-250		250	22	35	ocynk galvanized гальваника	stal steel сталь	15
PK-S-H45-300		300					
PK-S-H45-350		350					
PK-S-H45-400		400					
PK-S-H45-450		450					
PK-S-H45-500		500					
PK-S-H45-550		550					10
PK-S-H45-600		600					
PK-S-H45-650		650					
PK-S-H45-700		700					



Prowadnica kulkowa push to open H45 GX
 Ball bearing slide push to open H45 GX
 Шариковая направляющая push to open H45 GX



Możliwość zastosowania stabilizatora PB-D-P20STAB

Can be used with stabilizer PB-D-P20STAB

Возможность использования стабилизатора PB-D-P20STAB

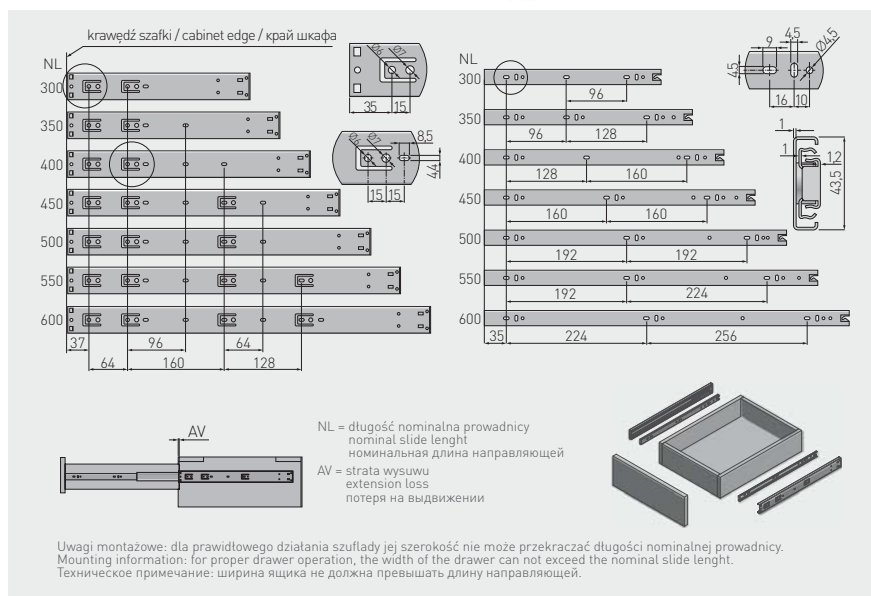

	L mm	AV mm		kg		
PK-P-H45-300-GX	300*	30	pełny full полное	25	osynek galvanized гальваника	stal steel сталь
PK-P-H45-350-GX	350					
PK-P-H45-400-GX	400					
PK-P-H45-450-GX	450					
PK-P-H45-500-GX	500					
PK-P-H45-550-GX	550					
PK-P-H45-600-GX	600					

* Brak pełnego wysuwu / Not full extension / Неполное выдвигание



Prowadnica kulkowa H45 PRO
 Ball bearing slide H45 PRO
 Шариковая направляющая H45 PRO



krzewi szafki / cabinet edge / край шкафа

NL = długość nominalna prowadnicy
 nominal slide length
 номинальная длина направляющей

AV = strata wysuwu
 extension loss
 потеря на выдвигании

NL (mm)	*a (mm)
300	21
350	49
400	89
450	94,5
500	115
550	115,5
600	156
650	167

Uwagi montażowe: dla prawidłowego działania szuflady jej szerokość nie może przekraczać długości nominalnej prowadnicy.
 Mounting information: for proper drawer operation, the width of the drawer can not exceed the nominal slide length.
 Техническое примечание: ширина ящика не должна превышать длину направляющей.







	L mm	AV mm					
PK-PRO-H45-250	250	5	pełny full полное	50	ocynk galwanizacja гальванізація	stal steel сталь	15
PK-PRO-H45-300	300						
PK-PRO-H45-350	350						
PK-PRO-H45-400	400						
PK-PRO-H45-450	450						
PK-PRO-H45-500	500						
PK-PRO-H45-550	550						
PK-PRO-H45-600	600						
PK-PRO-H45-650	650						

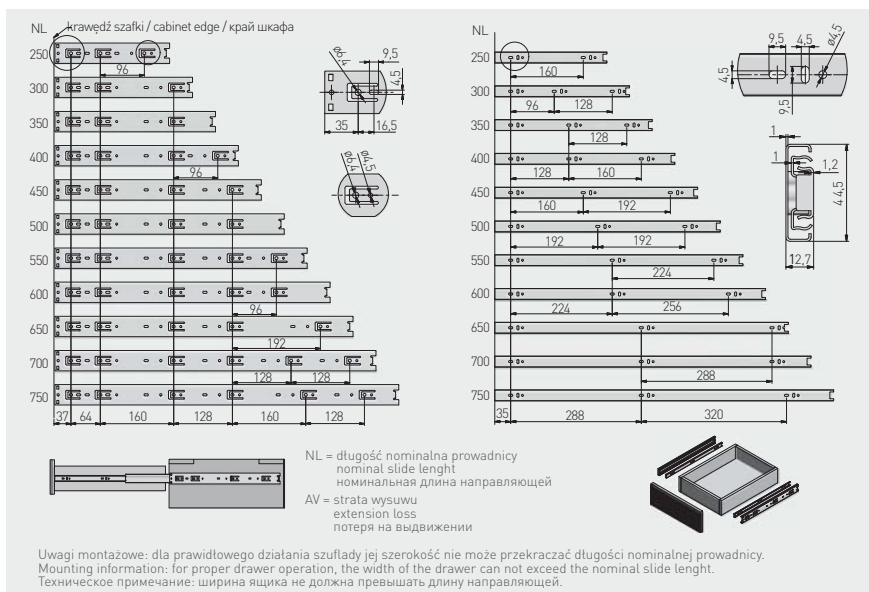



Prowadnica kulkowa H45 PRESTIGE
 Ball bearing slide H45 PRESTIGE
 Шариковая направляющая H45 PRESTIGE







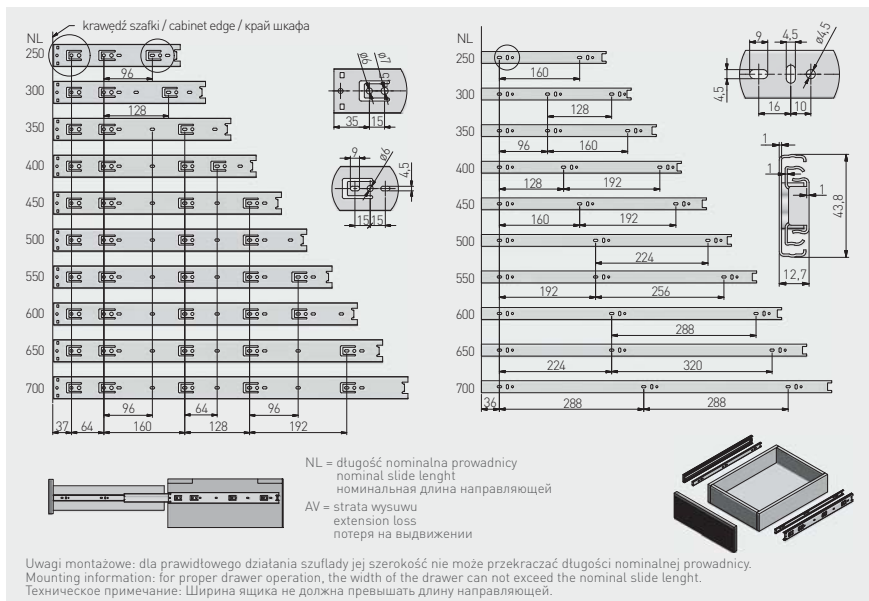

		 L mm	 AV mm					
PK-0-H45-250		250						
PK-0-H45-300		300						
PK-0-H45-350		350						
PK-0-H45-400		400						15
PK-0-H45-450		450			35	ocynk galvanized	stal steel	
PK-0-H45-500		500						
PK-0-H45-550		550						
PK-0-H45-600		600						10
PK-0-H45-700		700						



Prowadnica kulkowa H45 GX1
Ball bearing slide H45 GX1
Шариковая направляющая H45 GX1



		 L mm	 AV mm				
PK-0H45250GX1		250	5	pełny full полное	30	ocynk galvanized гальваника	stal steel сталь
PK-0H45300GX1		300					
PK-0H45350GX1		350					
PK-0H45400GX1		400					
PK-0H45450GX1		450					
PK-0H45500GX1		500					
PK-0H45550GX1		550					
PK-0H45600GX1		600					
PK-0H45650GX1		650					
PK-0H45700GX1		700					



Prowadnica kulkowa H35
Ball bearing slide H35
Шариковая направляющая H35

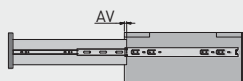
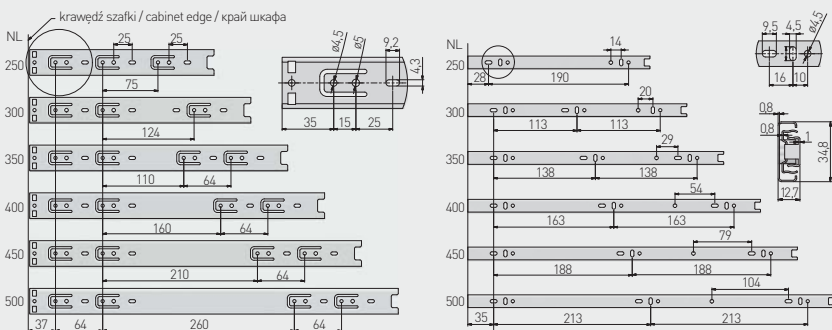

NL = długość nominalna prowadnicy
nominal slide length
номинальная длина направляющей
AV = strata wysuwu
extension loss
потеря на выдвигении

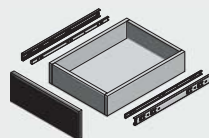





Uwagi montażowe: dla prawidłowego działania szuflady jej szerokość nie może przekraczać długości nominalnej prowadnicy.
Mounting information: for proper drawer operation, the width of the drawer can not exceed the nominal slide length.
Техническое примечание: Ширина ящика не должна превышать длину направляющей.

Model	Length (mm)	Width (mm)	Material	Weight (kg)	Finish	Material	Quantity
PK-0H35-2500	250	4	petny full полное	20	ocynk galvanized гальваника	stal steel сталь	30
PK-0-H35-3000	300						20
PK-0-H35-3500	350						20
PK-0-H35-4000	400						20
PK-0-H35-4500	450						20
PK-0-H35-5000	500						20

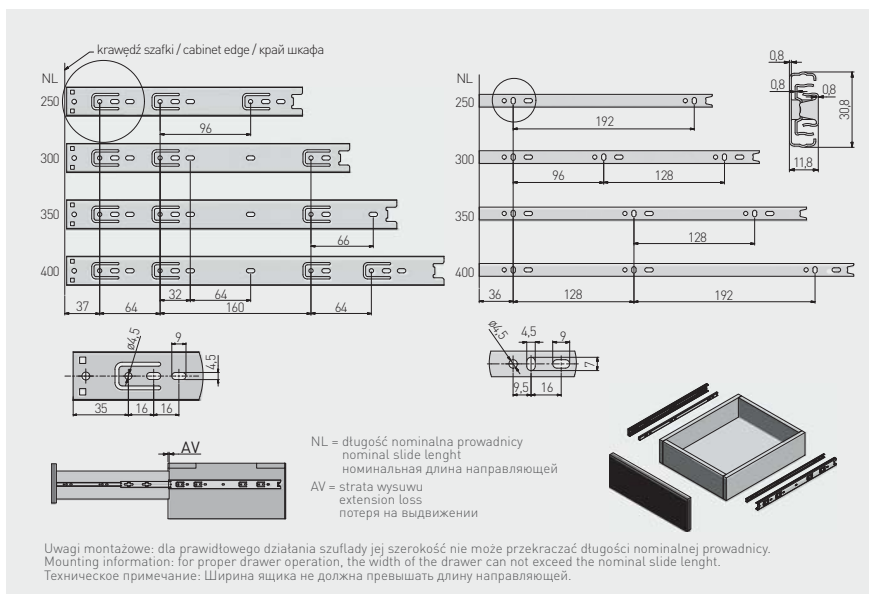

Prowadnica kulkowa H30
Ball bearing slide H30
Шариковая направляющая H30



	 L mm	 AV mm		 kg ↓		
PK-0H30-2500	250	-	pełny full полное	15	ocynk galvanized гальваника	stal steel сталь
PK-0H30-3000	300					
PK-0H30-3500	350					
PK-0H30-4000	400					





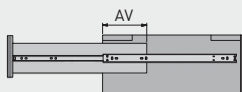
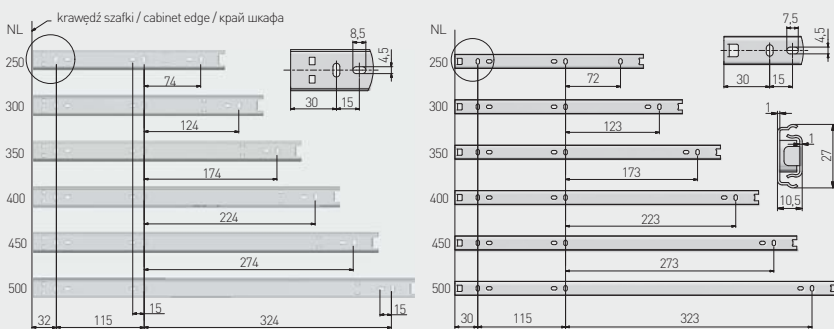

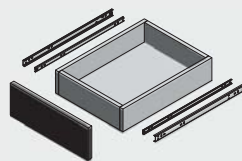

Prowadnica kulkowa H27
 Ball bearing slide H27
 Шариковая направляющая H27



NL = długość nominalna prowadnicy
 nominal slide length
 номинальная длина направляющей
 AV = strata wysuwu
 extension loss
 потеря на выдвигании







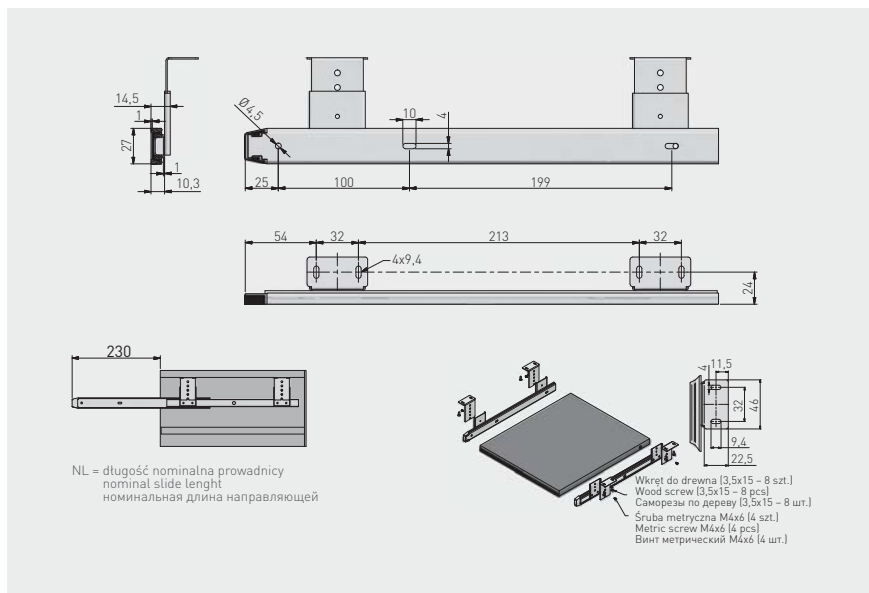

Uwagi montażowe: dla prawidłowego działania szuflady jej szerokość nie może przekraczać długości nominalnej prowadnicy.
 Mounting information: for proper drawer operation, the width of the drawer can not exceed the nominal slide length.
 Техническое примечание: Ширина ящика не должна превышать длину направляющей.

	 L mm	 AV mm		 kg		
PK-0H27-3000	300	109	niepełny partial неполное	15	ocynk galvanized гальваника	stal steel сталь
PK-0H27-3500	350	124				
PK-0H27-4000	400	134				
PK-0H27-4500	450	149				
PK-0H27-5000	500	184				



Prowadnica kulkowa do półki pod klawiaturę H27
 Ball bearing slide for keyboard H27
 Шариковая направляющая для полки под клавиатуру H27







	 mm		 kg		
PK-0-000-027	360	niepełny partial неполное	5	ocynk galvanized гальваника	stal steel сталь

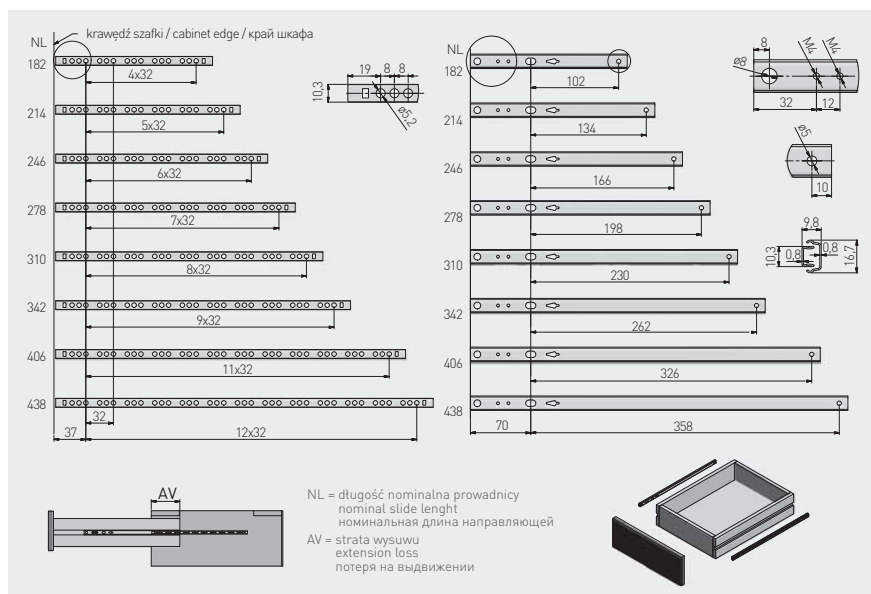

Prowadnica kulkowa H17
 Ball bearing slide H17
 Шариковая направляющая H17



		L mm	AV mm		kg ↓			
PK-0H17182XP		182	62	niepełny partial неполное	8	ocynk galvanized гальваника	stal steel сталь	100
PK-0H17214XP		214	77					
PK-0H17246XP		246						
PK-0H17278XP		278						
PK-0H17310XP		310						
PK-0H17342XP		342						
PK-0H17406XP		406	100					
PK-0H17438XP		438						50



Prowadnica rolkowa 0B
Euro roller slide 0B
Роликовая направляющая 0B

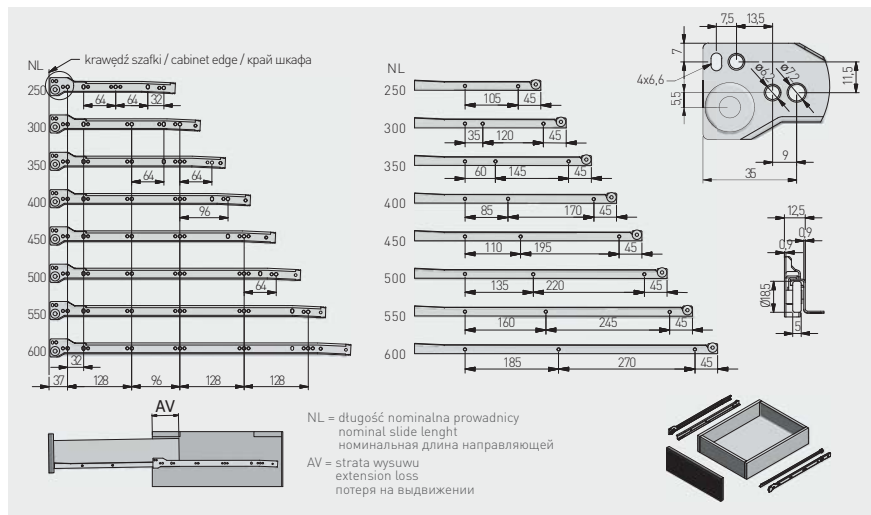

PR-0B-250-10	250								
PR-0B-300-10	300								
PR-0B-350-10	350	100							
PR-0B-400-10	400								
PR-0B-450-10	450								
PR-0B-500-10	500	110							
PR-0B-550-10	550	115							
PR-0B-600-10	600	125							
PR-0B-250-30	250								
PR-0B-300-30	300								
PR-0B-350-30	350	100							
PR-0B-400-30	400								
PR-0B-450-30	450								
PR-0B-500-30	500	110							
PR-0B-250-18	250								
PR-0B-300-18	300								
PR-0B-350-18	350	100							
PR-0B-400-18	400								
PR-0B-450-18	450								
PR-0B-500-18	500	110							
PR-0B-550-18	550	115							
PR-0B-600-18	600	125							
			niepełny / partial / неполное	20	biały / white / белый	stal / steel / сталь	brązowy / brown / коричневый		stal / steel / сталь
			niepełny / partial / неполное	20			szary / gray / серый		



Prowadnica Metalbox MP
Slide Metalbox MP
Направляющая Metalbox MP





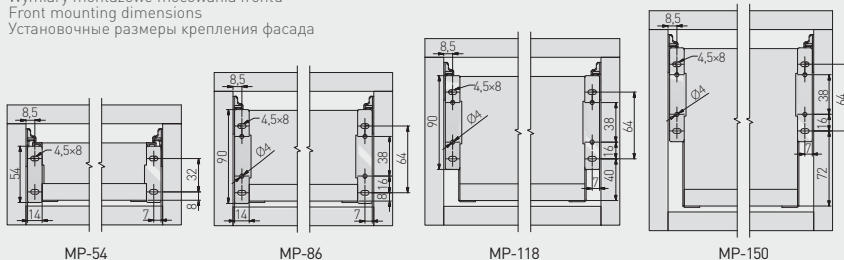



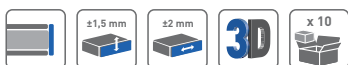
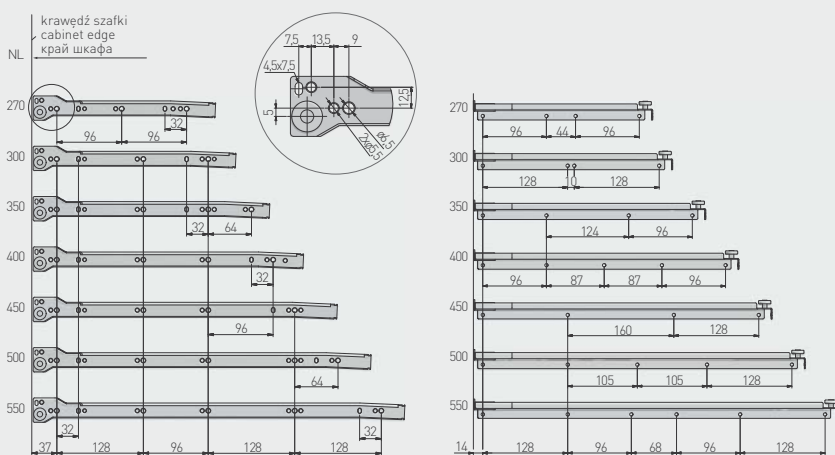

Wymiary montażowe mocowania frontu
Front mounting dimensions
Установочные размеры крепления фасада







Rozstaw otworów montażowych
Mounting dimensions
Монтажные отверстия

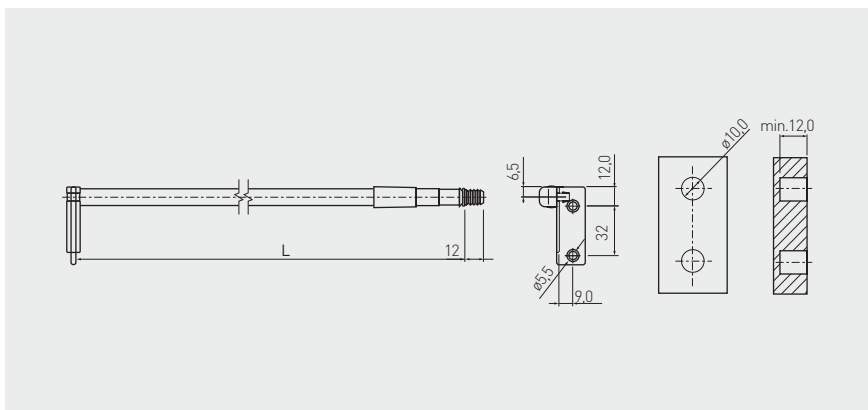

		 H mm	 L mm	 AV mm				
MP-054350-10	54	350	88	niepełny partial неполное	25	lakier lacquer лак	biały white белый	stal steel сталь
MP-054400-10		400	98					
MP-054450-10		450						
MP-054500-10		500						
MP-054450-80		450						
MP-054500-80		500	szary gray серый					
MP-086350-10	86	350	88	niepełny partial неполное	25	lakier lacquer лак	biały white белый	stal steel сталь
MP-086450-10		450	98					
MP-086350-80		350	88					
MP-086450-80		450	98					
MP-118350-10	118	350	88	niepełny partial неполное	25	lakier lacquer лак	biały white белый	stal steel сталь
MP-118400-10		400	98					
MP-118450-10		450						
MP-118500-10		500						
MP-150350-10	150	350	88	niepełny partial неполное	25	lakier lacquer лак	biały white белый	stal steel сталь
MP-150400-10		400	98					
MP-150450-10		450						
MP-150500-10		500						
MP-150350-80		350	88				szary gray серый	
MP-150400-80		400	98					
MP-150450-80		450						
MP-150500-80		500						

Reling z uchwytem ścianki tylnej lewy / prawy
 Rail with back panel connector left / right
 Релинг с ручкой задней стенки левый / правый



	 L mm	
RS-SZ-400-10	393 / 404	biały / white / белый
RS-SZ-450-10	443 / 454	
RS-SZ-500-10	493 / 504	

L – długość rzeczywista relingu mieszcząca się w przedziale (Lmin.; Lmax.) / actual length / фактическая длина релинга в пределах (Lмин; Lмакс)



Spowniacz do prowadnic rolkowych oraz szuflad typu Metalbox 350-550 mm
 Soft closing device for euro roller slide and Metalbox 350-550 mm
 Доводчик для роликовых направляющих и Металбоксов 350-550 мм



			
AM-MBSOFT-P2	25	szary gray серый	tworzywo plastic пластмасса

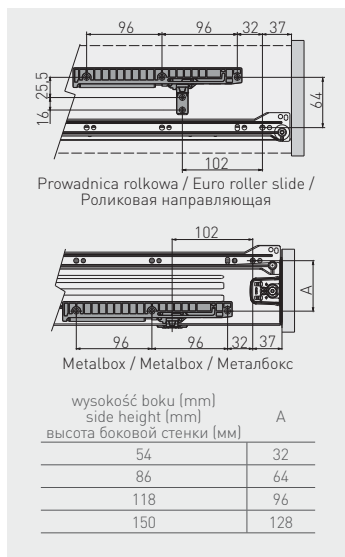

Rolka stabilizująca
 Drawer stabilizer
 Стабилизирующий механизм

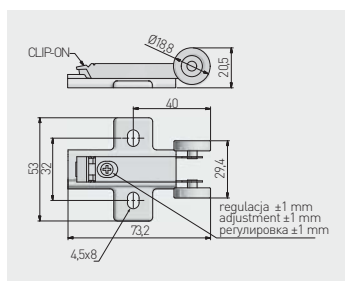

Do szuflad skrzyniowych wyposażonych w prowadnice push to open
 For drawers with push to open
 Для ящиков с направляющими push to open

		
PB-D-P20STAB	nikiel / nickel / никель	stal / steel / сталь



AXIS PRO

Skład zestawu
Set
Комплектация

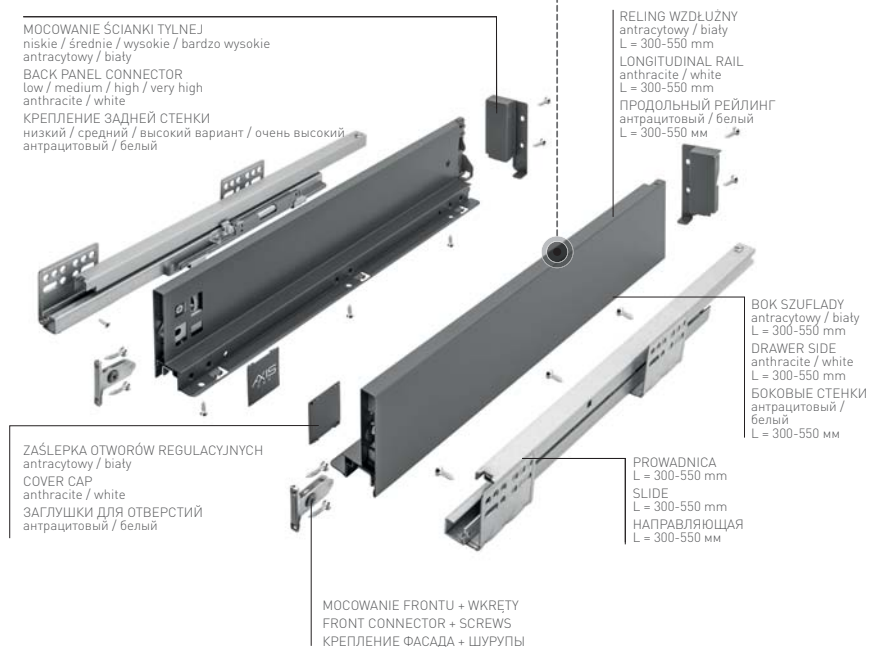

AXIS PRO

Komplet szuflady niskiej A
Low drawer set A
Низкий ящик A

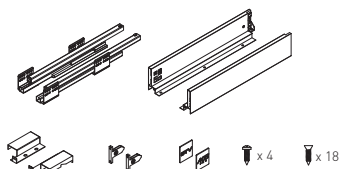

PB-AXISPRO-KPL300A	300	40	antracyt anthracite антрацитовый	lakier lacquer лак	stal steel сталь	
PB-AXISPRO-KPL350A	350					
PB-AXISPRO-KPL400A	400					
PB-AXISPRO-KPL450A	450					
PB-AXISPRO-KPL500A	500					
PB-AXISPRO-KPL550A	550					
PB-AXISPRO-KPL300A1	300					biały white белый
PB-AXISPRO-KPL350A1	350					
PB-AXISPRO-KPL400A1	400					
PB-AXISPRO-KPL450A1	450					
PB-AXISPRO-KPL500A1	500					
PB-AXISPRO-KPL550A1	550					

AXIS PRO

Komplet szuflady średniej B
Medium drawer set B
Средний ящик B

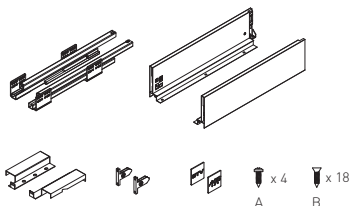

PB-AXISPRO-KPL300B	300	40	antracyt anthracite антрацитовый	lakier lacquer лак	stal steel сталь	
PB-AXISPRO-KPL350B	350					
PB-AXISPRO-KPL400B	400					
PB-AXISPRO-KPL450B	450					
PB-AXISPRO-KPL500B	500					
PB-AXISPRO-KPL550B	550					
PB-AXISPRO-KPL300B1	300					biały white белый
PB-AXISPRO-KPL350B1	350					
PB-AXISPRO-KPL400B1	400					
PB-AXISPRO-KPL450B1	450					
PB-AXISPRO-KPL500B1	500					
PB-AXISPRO-KPL550B1	550					

AXIS PRO

Komplet szuflady wysokiej C
High drawer set C
Высокий ящик C

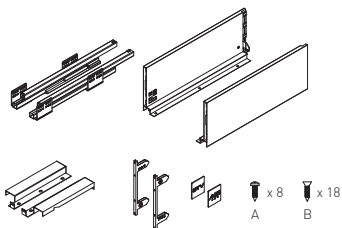

PB-AXISPRO-KPL300C	300	40	antracyt anthracite антрацитовый	lakier lacquer лак	stal steel сталь	
PB-AXISPRO-KPL350C	350					
PB-AXISPRO-KPL400C	400					
PB-AXISPRO-KPL450C	450					
PB-AXISPRO-KPL500C	500					
PB-AXISPRO-KPL550C	550					
PB-AXISPRO-KPL300C1	300					biały white белый
PB-AXISPRO-KPL350C1	350					
PB-AXISPRO-KPL400C1	400					
PB-AXISPRO-KPL450C1	450					
PB-AXISPRO-KPL500C1	500					
PB-AXISPRO-KPL550C1	550					

AXIS PRO

Komplet szuflady bardzo wysokiej D
Very high drawer set D
Очень высокий ящик D

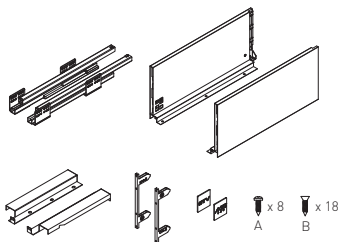





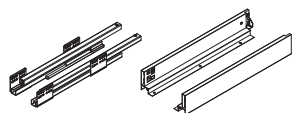

PB-AXISPRO-KPL300D	300	40	antracyt anthracite антрацитовый	lakier lacquer лак	stal steel сталь	
PB-AXISPRO-KPL350D	350					
PB-AXISPRO-KPL400D	400					
PB-AXISPRO-KPL450D	450					
PB-AXISPRO-KPL500D	500					
PB-AXISPRO-KPL550D	550					
PB-AXISPRO-KPL300D1	300					biały white белый
PB-AXISPRO-KPL350D1	350					
PB-AXISPRO-KPL400D1	400					
PB-AXISPRO-KPL450D1	450					
PB-AXISPRO-KPL500D1	500					
PB-AXISPRO-KPL550D1	550					

AXIS PRO

Komplet szuflady ekstra niskiej
Very low drawer set
Набор ящиков очень низких







		 L mm	 kg			
PB-AXISPRO-KPL69-450-60		450	40	antracyt anthracite антрацитовый	lakier lacquer лак	stal steel сталь
PB-AXISPRO-KPL69-500-60		500				
PB-AXISPRO-KPL69-450-10		450		biały white белый		
PB-AXISPRO-KPL69-500-10		500				

Złączka frontu wewnętrznej niska

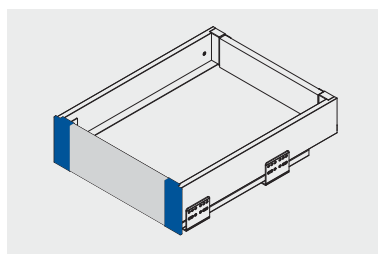
Inner front connector low

Соединитель передней панели, низкий



			
PB-AXISPRO-WEWMOCA		antracyt anthracite антрацитовый	stal steel сталь
PB-AXISPRO-WEWMOCA1		biały white белый	

Złączka frontu wewnętrznego średnia
 Inner front connector medium
 Соединитель передней панели, передней

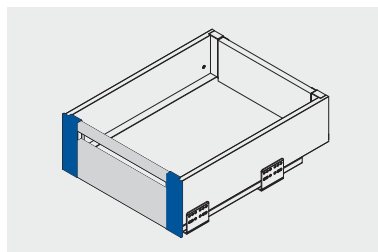

PB-AXISPRO-WEWMOCB	antracyt anthracite антрацитовый	stal steel сталь
PB-AXISPRO-WEWMOCB1	biały white белый	

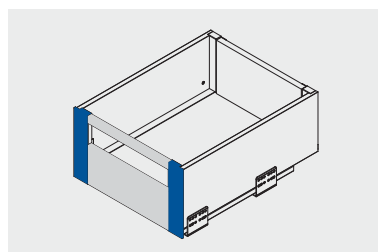

Złączka frontu wewnętrznego wysoka
 Inner front connector high
 Соединитель передней панели, высокий



PB-AXISPRO-WEWMOCB	antracyt anthracite антрацитовый	stal steel сталь
PB-AXISPRO-WEWMOCB1	biały white белый	

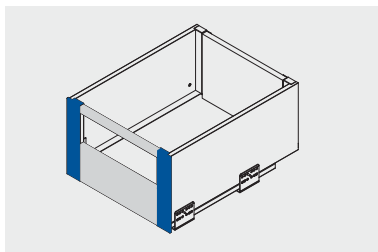

Złączka frontu wewnętrznego bardzo wysoka
 Inner front connector very high
 Соединитель передней панели, очень высокий



			
PB-AXISPRO-WEWM0CD		antracyt anthracite антрацитовый	stal steel сталь
PB-AXISPRO-WEWM0CD1		biały white белый	

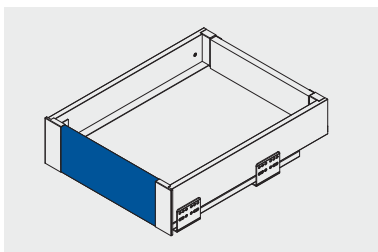
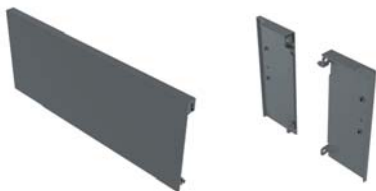



Zestaw do szuflady wewnętrznej niskiej
 Set for low inside drawer
 Набор для внутреннего нижнего ящика

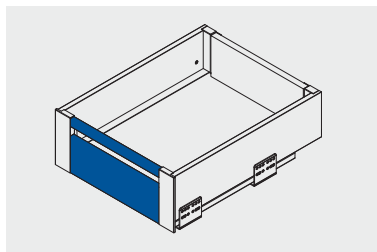

		 H mm	 L mm		
PB-AXISPRO-ZESWEW-A AXISPRO		110	1200	antracyt anthracite антрацитовый	stal steel сталь
PB-AXISPRO-ZESWEW-A1 AXISPRO				biały white белый	





Zestaw do szuflady wewnętrznej średniej
Set for medium inside drawer
Набор для среднего внутреннего ящика

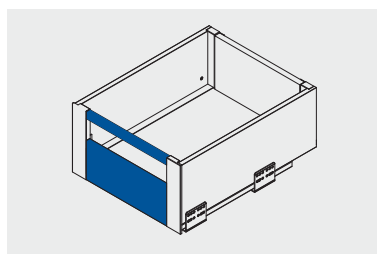
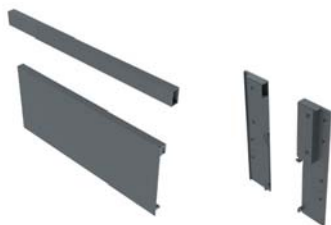

	 H mm	 L mm		
PB-AXISPRO-ZESWEW-B AXISPRO	95	1200	antracyt anthracite антрацитовый	stal steel сталь
PB-AXISPRO-ZESWEW-B1 AXISPRO			biały white белый	





Zestaw do szuflady wewnętrznej wysokiej
Set for high inside drawer
Набор для внутреннего высокого ящика

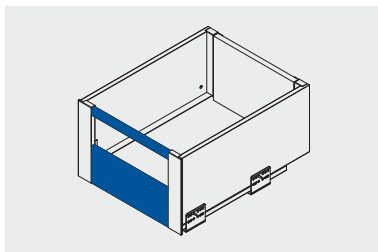
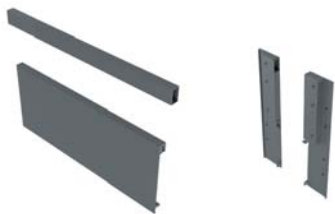

	 H mm	 L mm		
PB-AXISPRO-ZESWEW-C AXISPRO	110	1200	antracyt anthracite антрацитовый	stal steel сталь
PB-AXISPRO-ZESWEW-C1 AXISPRO			biały white белый	





Zestaw do szuflady wewnętrznej bardzo wysokiej
 Set for very high inside drawer
 Набор для очень высокого внутреннего ящика

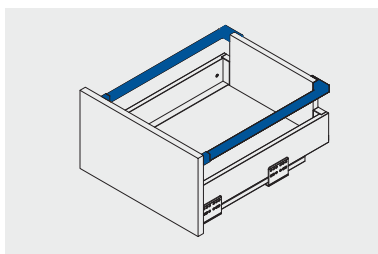

		 H mm	 L mm		
PB-AXISPRO-ZESWEW-D AXISPRO		110	1200	antracyt anthracite антрацитовый	stal steel сталь
PB-AXISPRO-ZESWEW-D1 AXISPRO				biały white белый	

Reling wzłużny kwadratowy
 Square longitudinal railing
 Квадратные продольные перила



		 L mm		
PB-AXISPRO-RELKW300		300	antracyt anthracite антрацитовый	stal steel сталь
PB-AXISPRO-RELKW350		350		
PB-AXISPRO-RELKW400		400		
PB-AXISPRO-RELKW450		450		
PB-AXISPRO-RELKW500		500		
PB-AXISPRO-RELKW550		550	biały white белый	
PB-AXISPRO-RELKW300-10		300		
PB-AXISPRO-RELKW350-10		350		
PB-AXISPRO-RELKW400-10		400		
PB-AXISPRO-RELKW450-10		450		
PB-AXISPRO-RELKW500-10		500		
PB-AXISPRO-RELKW550-10		550		

Modern Box Square

Skład zestawu

Set

Комплектация

MOCOWANIE ŚCIANKI TYLNEJ

niskie / średnie / wysokie
szare / biały

BACK PANEL CONNECTOR

low / medium / high
gray / white

КРЕПЛЕНИЕ ЗАДНЕЙ СТЕНКИ

низкий / средний / высокий вариант
серый / белый

RELING WZDŁUŻNY

szary / biały
L = 250-550 mm

LONGITUDINAL RAIL

gray / white
L = 250-550 mm

ПРОДОЛЬНЫЙ РЕЙЛИНГ

серый / белый
L = 250-550 мм

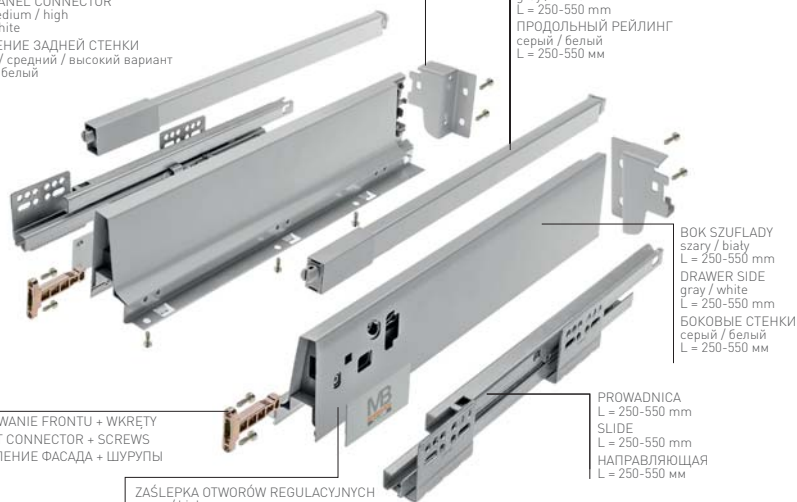

BOK SZUFLADY

szary / biały
L = 250-550 mm

DRAWER SIDE

gray / white
L = 250-550 mm

БОКОВЫЕ СТЕНКИ

серый / белый
L = 250-550 мм

MOCOWANIE FRONTU + WKRETY

FRONT CONNECTOR + SCREWS
КРЕПЛЕНИЕ ФАСАДА + ШУРУПЫ

ZASŁEPKA OTWORÓW REGULACYJNYCH

szara / biała

COVER CAP

gray / white

ЗАГЛУШКИ ДЛЯ ОТВЕРСТИЙ
серый / белый

PROWADNICA

L = 250-550 mm

SLIDE

L = 250-550 mm

НАПРАВЛЯЮЩАЯ

L = 250-550 мм



Modern Box Square

Komplet szuflady niskiej A
Low drawer set A
Низкий ящик A

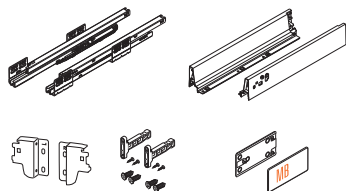

PB-KW-KPL300A	300	40	szary gray серый	lakier lacquer лак	stal steel сталь
PB-KW-KPL350A	350				
PB-KW-KPL400A	400				
PB-KW-KPL450A	450				
PB-KW-KPL500A	500				
PB-KW-KPL550A	550				
PB-KW-KPL250A1	250				
PB-KW-KPL300A1	300				
PB-KW-KPL350A1	350				
PB-KW-KPL400A1	400				
PB-KW-KPL450A1	450				
PB-KW-KPL500A1	500				
PB-KW-KPL550A1	550				
PB-KW-KPL250A2	250				
PB-KW-KPL300A2	300				
PB-KW-KPL350A2	350				
PB-KW-KPL400A2	400				
PB-KW-KPL450A2	450				
PB-KW-KPL500A2	500				
PB-KW-KPL550A2	550				

Modern Box Square

Komplet szuflady średniej B
Medium drawer set B
Средний ящик B

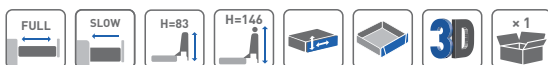
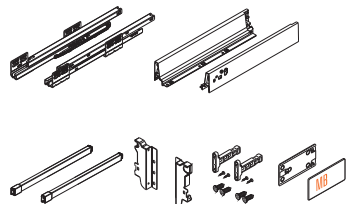

PB-KW-KPL250B	250	40	szary gray серый	lakier lacquer лак	stal steel сталь
PB-KW-KPL350B	350				
PB-KW-KPL400B	400				
PB-KW-KPL450B	450				
PB-KW-KPL500B	500				
PB-KW-KPL550B	550				
PB-KW-KPL250B1	250				
PB-KW-KPL300B1	300				
PB-KW-KPL350B1	350				
PB-KW-KPL400B1	400				
PB-KW-KPL450B1	450				
PB-KW-KPL500B1	500				
PB-KW-KPL550B1	550				
PB-KW-KPL250B2	250				
PB-KW-KPL300B2	300				
PB-KW-KPL350B2	350				
PB-KW-KPL400B2	400				
PB-KW-KPL450B2	450				
PB-KW-KPL500B2	500				
PB-KW-KPL550B2	550				

Modern Box Square

Komplet szuflady wysokiej C
High drawer set C
Высокий ящик C

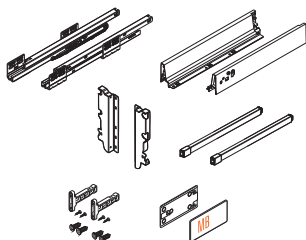

PB-KW-KPL250C	250	40	szary gray серый	lakier lacquer лак	stal steel сталь
PB-KW-KPL300C	300				
PB-KW-KPL350C	350				
PB-KW-KPL400C	400				
PB-KW-KPL450C	450				
PB-KW-KPL500C	500				
PB-KW-KPL550C	550				
PB-KW-KPL250C1	250		biały white белый		
PB-KW-KPL300C1	300				
PB-KW-KPL350C1	350				
PB-KW-KPL400C1	400				
PB-KW-KPL450C1	450				
PB-KW-KPL500C1	500	antracyt anthracite антрацитовый			
PB-KW-KPL550C1	550				
PB-KW-KPL250C2	250				
PB-KW-KPL300C2	300				
PB-KW-KPL350C2	350				
PB-KW-KPL400C2	400				
PB-KW-KPL450C2	450				
PB-KW-KPL500C2	500				
PB-KW-KPL550C2	550				



Reiling wzdłużny Longitudinal drawer rail Продольный рейлинг

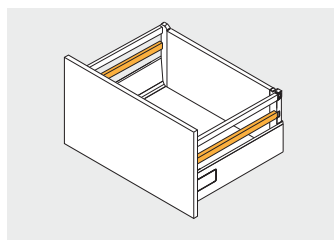

PB-D-RELKW350	350	szary gray серый	lakier lacquer лак	stal steel сталь
PB-D-RELKW400	400			
PB-D-RELKW450	450			
PB-D-RELKW500	500			
PB-D-RELKW550	550			







PB-D-RELKW350-10	350	biały white белый	lakier lacquer лак	stal steel сталь
PB-D-RELKW400-10	400			
PB-D-RELKW450-10	450			
PB-D-RELKW500-10	500			
PB-D-RELKW550-10	550			

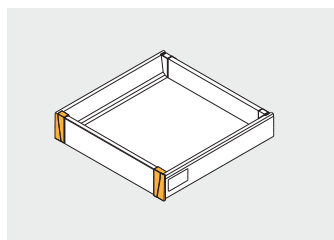

Złączka frontu wewnętrznego, niska
 Inner front connector, low
 Соединитель передней панели, низкий





			
PB-D-WEWMOCA-KW	szuflada niska A low drawer A низкий ящик A	szary / gray / серый	tworzywo plastic пластмасса
PB-D-WEWMOCA-KW-10		biały / white / белый	

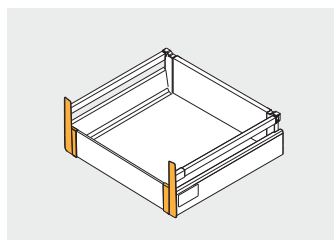

Złączka frontu wewnętrznego, średnia
 Inner front connector, medium
 Соединитель передней панели, средний



			
PB-D-WEWMOCB-KW	szuflada średnia B medium drawer B средний ящик B	szary / gray / серый	tworzywo plastic пластмасса
PB-D-WEWMOCB-KW-10		biały / white / белый	



Złączka frontu wewnętrznego, wysoka
 Inner front connector, high
 Соединитель передней панели, высокий

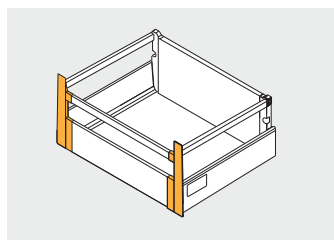

PB-D-WEWMOCC-KW	szuflada wysoka C high drawer C высокий ящик C	szary / gray / серый	tworzywo plastic пластмасса
PB-D-WEWMOCC-KW-10		biały / white / белый	
PB-D-WEWMOCC-KW-60		antracyt / anthracite / антрацитовый	



Zestaw do szuflady wewnętrznej wysokiej Modern Box Square
 Set for high inside drawer Modern Box Square
 Набор для внутреннего высокого ящика Modern Box Square

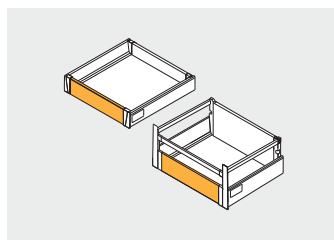

PB-D-ZESWEWKW-C	1100	szary / gray / серый	aluminium aluminium алюминий
PB-D-ZESWEWKW-C-10		biały / white / белый	
PB-D-ZESWEWKW-C-60		antracyt / anthracite / антрацитовый	



Zestaw do organizacji szuflady wewnętrznej Modern Box Square
 Set for inside drawer organization Modern Box Square
 Комплект для внутренней организации ящиков Modern Box Square

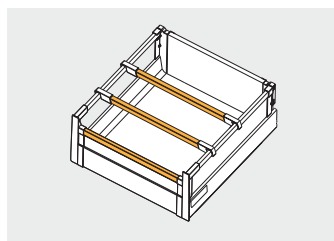

	 L mm		
PB-D-WEWORGKW-A	1100	szary / gray / серый	stal steel сталь
PB-D-WEWORGKW-A-10		biały / white / белый	
PB-D-WEWORGKW-A-60		antracyt / anthracite / антрацитовый	



Łącznik relingu poprzecznego
 Transverse rail connector
 Соединитель поперечного рейлинга

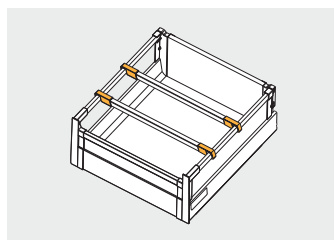

			
PB-D-ZR-KW-00	1 kpl. = 2 szt. 1 set = 2 pcs 1 комп. = 2 шт.	szary / gray / серый	tworzywo plastic пластмасса
PB-D-ZR-KW-10		biały / white / белый	
PB-D-ZR-KW-60		antracyt / anthracite / антрацитовый	



Zestaw do organizacji szuflady wewnętrznej
Set for inside drawer organization
Комплект для внутренней организации ящиков

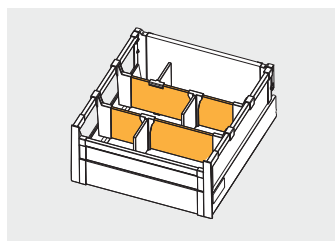





	 L mm		
PB-D-WEWORGKW-B	1100	szary / gray / серый	aluminium aluminium алюминий
PB-D-WEWORGKW-B-10		biały / white / белый	
PB-D-WEWORGKW-B-60		antracyt / anthracite / антрацитовый	

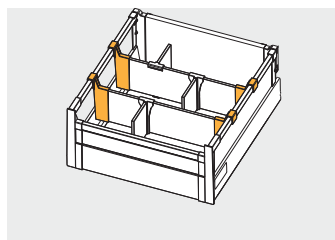

Złączka do listwy poprzecznej
Transverse bar connector
Соединитель поперечной планки



			
PB-D-CONREL-KW	1 kpl. = 2 szt. 1 set = 2 pcs 1 комп. = 2 шт.	szary / gray / серый	tworzywo plastic пластмасса
PB-D-CONREL-KW-10		biały / white / белый	
PB-D-CONREL-KW-60		antracyt / anthracite / антрацитовый	



Przegroda do listwy poprzecznej
 Transverse bar divider
 Перегородка для поперечной планки

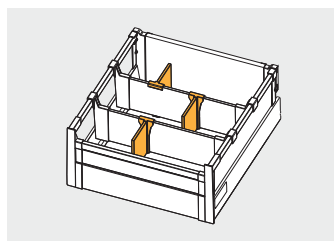

PB-D-PRZEGLP-KW	1 szt. 1 pc	szary / gray / серый	tworzywo plastic пластмасса
PB-D-PRZEGLP-KW-10	1 шт.	biały / white / белый	



Mocowanie relingu do podwyższonej ścianki tylnej
 Back panel connector for rails, additional
 Соединитель задней стенки для рейлингов, дополнительная

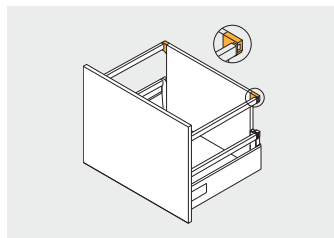

PB-D-D2R0-00	1 kpl. = 2 szt. 1 set = 2 pcs	szary / gray / серый	tworzywo plastic пластмасса
PB-D-D2R0-01	1 комп. = 2 шт.	biały / white / белый	



Bok perforowany
 Perforated side
 Перфорированная сторона

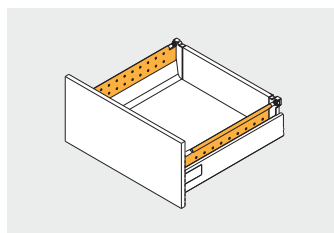

PB-D-BXSIDEKW25C	250	szary gray серый	stal steel сталь
PB-D-BXSIDEKW30C	300		
PB-D-BXSIDEKW35C	350		
PB-D-BXSIDEKW40C	400		
PB-D-BXSIDEKW50C	500		
PB-D-BXSIDEKW45C	450		
PB-D-BXSIDEKW25C-10	250	biały white белый	
PB-D-BXSIDEKW30C-10	300		
PB-D-BXSIDEKW35C-10	350		
PB-D-BXSIDEKW40C-10	400		
PB-D-BXSIDEKW45C-10	450		
PB-D-BXSIDEKW50C-10	500		
PB-D-BXSIDEKW25C-60	250	antracyt anthracite антрацитовый	
PB-D-BXSIDEKW30C-60	300		
PB-D-BXSIDEKW35C-60	350		
PB-D-BXSIDEKW40C-60	400		
PB-D-BXSIDEKW50C-60	500		
PB-D-BXSIDEKW45C-60	450		



Złączka ścianki tylnej, niska
 Back panel connector, low
 Держатель задней стенки, низкий

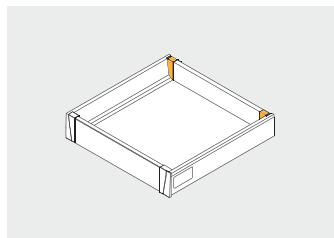

PB-D-N2R0-00	1 kpl. = L+P 1 set = L+R	szary / gray / серый	stal steel
PB-D-N2R0-01	1 комп. = Л+П	biały / white / белый	сталь



Złączka ścianki tylnej, średnia
 Back panel connector, medium
 Держатель задней стенки, средний

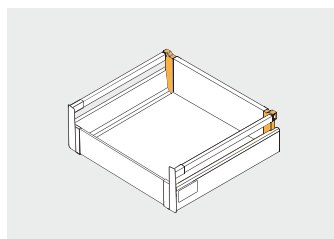

PB-D-S2R0-00	1 kpl. = L+P 1 set = L+R	szary / gray / серый	stal steel
PB-D-S2R0-01	1 комп. = Л+П	biały / white / белый	сталь



Złączka ścianki tylnej, wysoka
 Back panel connector, high
 Держатель задней стенки, высокий

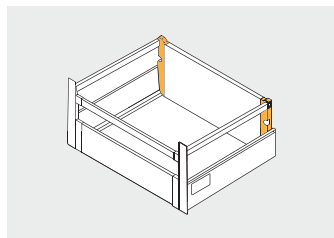

PB-D-W2R0-00	1 kpl. = L+P 1 set = L+R	szary / gray / серый	stal steel
PB-D-W2R0-01	1 комп. = Л+П	biały / white / белый	stal сталь



Mocowanie do relingów
 Rails mounting
 Держатель рейлинга



PB-D-MH604-KW	1 szt. 1 pc 1 шт.	szary gray серый	tworzywo plastic пластмасса
---------------	-------------------------	------------------------	-----------------------------------



Matryca do relingów
 Marking gauge for rails
 Матрица для рейлингов



			
PB-D-MATRYCA	1 kpl. = 1 szt. 1 set = 1 pc 1 комп. = 1 шт.	szary gray серый	tworzywo plastic пластмасса



Znacznik do frontów
 Marking gauge for drawer front
 Маркер фасада



			
PB-D-ZNACZ-0	1 kpl. = 2 szt. 1 set = 2 pcs 1 комп. = 2 шт.	szary gray серый	ZnAl



Modern Box



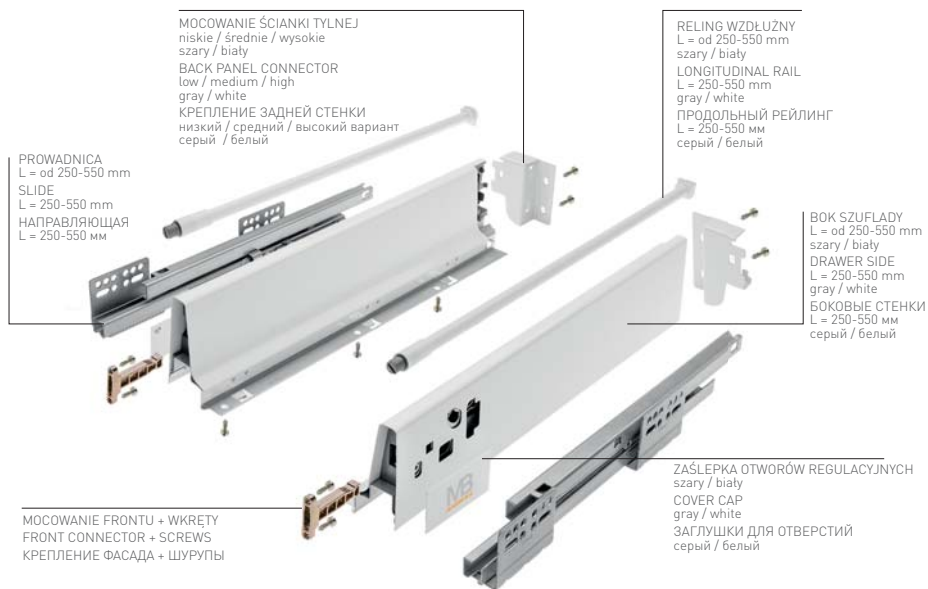



Skład zestawu
Set
Комплектация

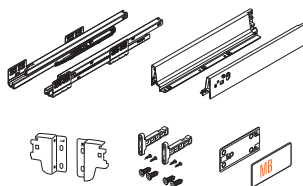

Modern Box

Komplet szuflady niskiej A
Low drawer set A
Низкий ящик A



	 L mm		 kg			
PB-D-KPL250A	250	soft close	40	szary gray серый	lakier lacquer лак	stal steel сталь
PB-D-KPL300A	300					
PB-D-KPL350A	350					
PB-D-KPL400A	400					
PB-D-KPL450A	450					
PB-D-KPL500A	500					
PB-D-KPL550A	550	push to open	40	szary gray серый	lakier lacquer лак	stal steel сталь
PB-D-KPL250A1	250					
PB-D-KPL300A1	300					
PB-D-KPL350A1	350					
PB-D-KPL400A1	400					
PB-D-KPL450A1	450					
PB-D-KPL500A1	500					
PB-D-KPL550A1	550					
PB-D-P20250A	250	push to open	40	szary gray серый	lakier lacquer лак	stal steel сталь
PB-D-P20300A	300					
PB-D-P20350A	350					
PB-D-P20400A	400					
PB-D-P20450A	450					
PB-D-P20500A	500					



Modern Box

Komplet szuflady średniej B
Medium drawer set B
Средний ящик B

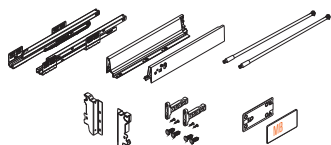

PB-D-KPL300B	300	soft close	40	szary gray серый	lakier lacquer лак	stal steel сталь
PB-D-KPL350B	350					
PB-D-KPL400B	400					
PB-D-KPL450B	450					
PB-D-KPL500B	500					
PB-D-KPL550B	550					

Modern Box



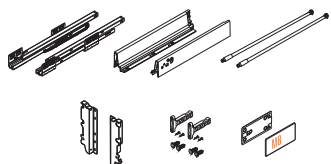



Komplet szuflady wysokiej C
High drawer set C
Высокий ящик C

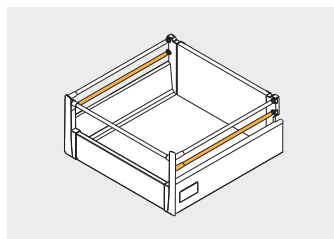





PB-D-KPL250C	250	soft close	40	szary gray серый	lakier lacquer лак	stal steel сталь
PB-D-KPL300C	300					
PB-D-KPL350C	350					
PB-D-KPL400C	400					
PB-D-KPL450C	450					
PB-D-KPL500C	500					
PB-D-KPL550C	550					
PB-D-KPL250C1	250					
PB-D-KPL300C1	300					
PB-D-KPL350C1	350					
PB-D-KPL400C1	400					
PB-D-KPL450C1	450					
PB-D-KPL500C1	500					
PB-D-KPL550C1	550					
PB-D-P20300C	300	push to open	40	szary gray серый	lakier lacquer лак	stal steel сталь
PB-D-P20350C	350					
PB-D-P20400C	400					
PB-D-P20450C	450					
PB-D-P20500C	500					
PB-D-P20550C	550					

Reлинг wzdużny
Longitudinal rail
Продольный рейлинг







	 mm		
PB-D-REL2500	250		
PB-D-REL3000	300		
PB-D-REL3500	350		
PB-D-REL4000	400		
PB-D-REL4500	450		
PB-D-REL5000	500		
PB-D-REL5500	550	szary gray серый	stal steel сталь

	 mm		
PB-D-REL450-10	450	biały white белый	stal steel сталь
PB-D-REL500-10	500		
PB-D-REL550-10	550		

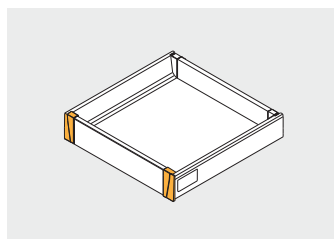

Złączka frontu wewnętrznej, niska
Inner front connector, low
Соединитель передней панели, низкий



			
PB-D-WEWMOCA	szuflada niska A low drawer A низкий ящик A	szary / gray / серый	tworzywo plastic пластмасса
PB-D-WEWMOCA1		biały / white / белый	



Złączka frontu wewnętrznego, średnia
 Inner drawer connector, medium
 Соединитель передней панели, средний

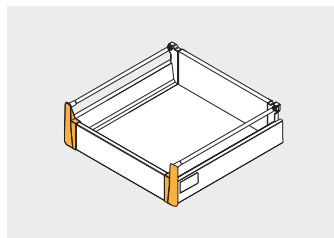

PB-D-WEWMOCB	szuflada średnia B medium drawer B средний ящик B	szary / gray / серый	tworzywo plastic пластмасса
PB-D-WEWMOCB1		biały / white / белый	



Złączka frontu wewnętrznego, wysoka, do 1 kompletu relingów
 Inner drawer connector high, for 1 set of rails
 Соединитель передней панели, высокий, для 1 комплекта рейлингов

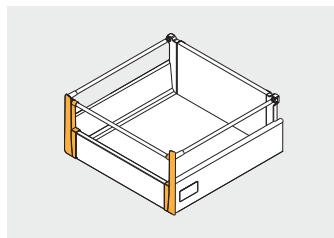

PB-D-WEWSZKLC	szuflada wysoka C, 1 reling high drawer C, 1 rail высокий ящик C, рейлинг -1 шт.	szary / gray / серый	tworzywo plastic пластмасса
PB-D-WEWSZKLC-10		biały / white / белый	



Złączka frontu wewnętrznej, wysoka, do 2 kompletów relingów
 Inner drawer front connector, high, for 2 sets of rails
 Соединитель передней панели, высокий, для 2 комплектов рельсов

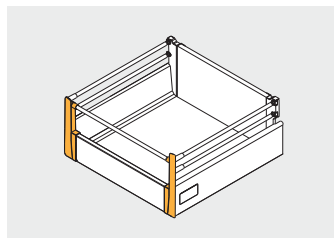

PB-D-WEWMOCC	szuflada wysoka C, 2 relingi high drawer C, 2 rails высокий ящик C, рейлинг -2 шт.	szary / gray / серый	tworzywo plastic пластмасса
PB-D-WEWMOCC1		biały / white / белый	



Zestaw do szuflady wewnętrznej wysokiej
 Set for high inside drawer
 Набор для внутреннего высокого ящика

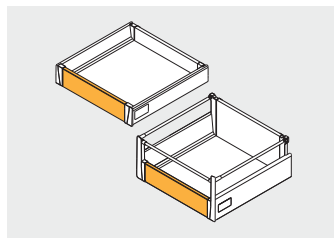





PB-D-ZESWEW-C	1100	szary / gray / серый	aluminium aluminium алюминий
PB-D-ZESWEW-C-10		biały / white / белый	

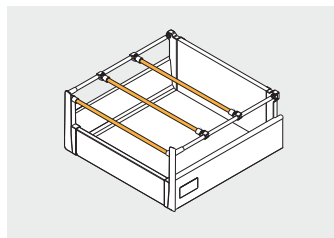

Reling poprzeczny
Transverse rail
Поперечный рейлинг



	 L mm		
PB-D-RP-1100	1100	szary / gray / серый	stal steel сталь
PB-D-RP-1100-10		biały / white / белый	



Łącznik relingu poprzecznego
Transverse rail connector
Соединитель поперечного рейлинга

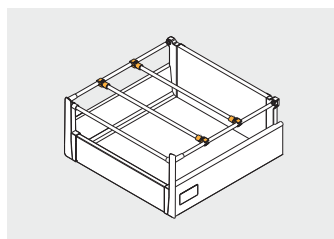

			
PB-D-ZR-00-0	1 kpl. = 2 szt. 1 set = 2 pcs 1 комп. = 2 шт.	szary / gray / серый	tworzywo plastic пластмасса
PB-D-ZR-00-10		biały / white / белый	



Uchwyt do szuflady wewnętrznej
 Inner drawer handle
 Ручка для внутреннего ящика

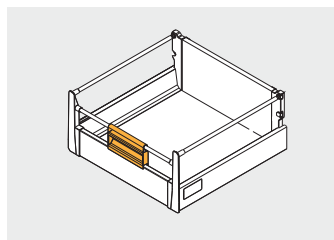

PB-D-UCHWEW	szary / gray / серый	tworzywo plastic пластмасса
PB-D-UCHWEW-10	biały / white / белый	



Łącznik krzyżowy do relingu
 Cross rail connector
 Крестообразный соединитель рейлингов

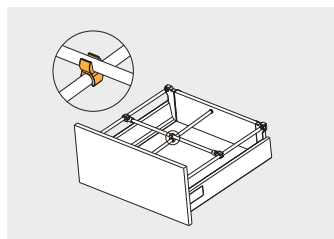

PB-D-LR-00-0	szary / gray / серый	tworzywo plastic пластмасса
PB-D-LR-00-10	biały / white / белый	



Zaślepka do relingu poprzecznego
End cap for transverse rail
Заглушка для поперечного рейлинга

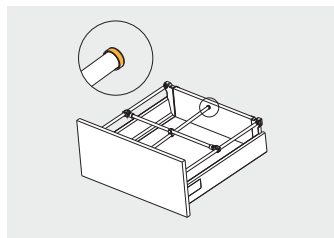

PB-D-RELCOV	szary / gray / серый	tworzywo plastic пластмасса
PB-D-RELCOV-10	biały / white / белый	



Zestaw do organizacji szuflady wewnętrznej
Set for inside drawer organization
Комплект для внутренней организации ящиков

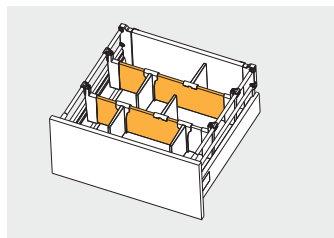

PB-D-WEWORG-B	1100	szary / gray / серый	aluminium aluminium алюминий
PB-D-WEWORG-B-10		biały / white / белый	



Złączka listwy poprzecznej do relingu
 Connector for transverse rail and bar
 Соединитель поперечных планок и рейлингов

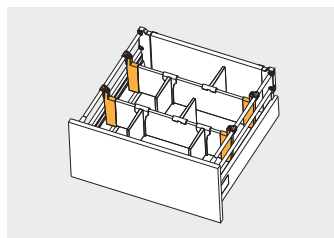

PB-D-CONREL	1 kpl. = 2 szt. 1 set = 2 pcs 1 комп. = 2 шт.	szary / gray / серый	tworzywo plastic пластмасса
PB-D-CONREL-10		biały / white / белый	



Złączka listwy poprzecznej do boku perforowanego
 Transverse bar connector for perforated sides
 Соединитель поперечных планок и перфорированных боковин

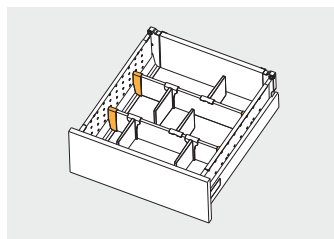

PB-D-CONBXSID	1 kpl. = 2 szt. 1 set = 2 pcs 1 комп. = 2 шт.	szary / gray / серый	tworzywo plastic пластмасса
PB-D-CONBXSIDE-10		biały / white / белый	



Przegroda listwy poprzecznej
 Transverse bar divider
 Перегородка для поперечной планки

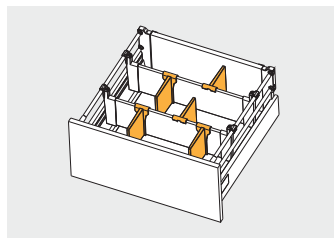

PB-D-PRZEGLP	szary / gray / серый	tworzywo plastic пластмасса
PB-D-PRZEGLP-10	biały / white / белый	



Bok perforowany do szuflady średniej
 Perforated side for medium drawer
 Перфорированная боковина, низкая

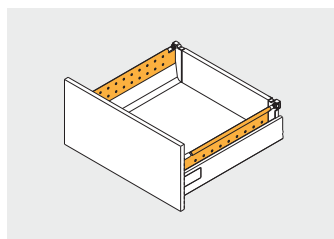





PB-D-BXSIDE45B	450	szary / gray / серый	stal steel сталь
PB-D-BXSIDE45B-10		biały / white / белый	
PB-D-BXSIDE50B	500	szary / gray / серый	
PB-D-BXSIDE50B-10		biały / white / белый	

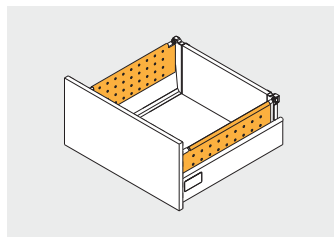
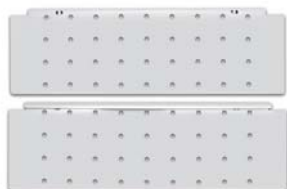

Bok perforowany do szuflady wysokiej
 Perforated side for high drawer
 Перфорированная боковина, высокая







	 L mm		
PB-D-BXSIDE45C	450	szary / gray / серый	stal steel сталь
PB-D-BXSIDE45C-10		biały / white / белый	
PB-D-BXSIDE50C	500	szary / gray / серый	
PB-D-BXSIDE50C-10		biały / white / белый	

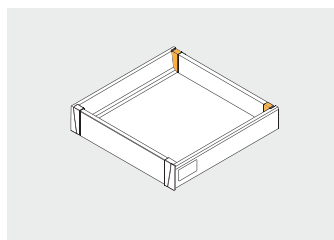

Złączka ścianki tylnej, niska
 Back panel connector, low
 Соединитель задней стенки, низкий







			
PB-D-N2R0-00	1 kpl. = L+P 1 set = L+R 1 комп. = Л+П	szary / gray / серый	stal steel сталь
PB-D-N2R0-01		biały / white / белый	

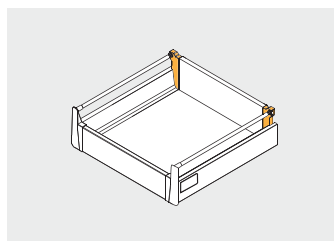

Złączka ścianki tylnej, średnia
 Back panel connector, medium
 Соединитель задней стенки, средний







			
PB-D-S2R0-00	1 kpl. = L+P 1 set = L+R	szary / gray / серый	stal steel
PB-D-S2R0-01	1 комп. = Л+П	biały / white / белый	сталь

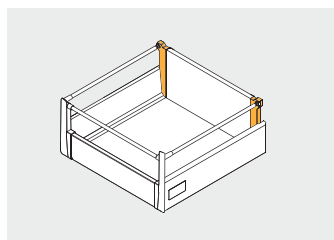

Złączka ścianki tylnej, wysoka
 Back panel connector, high
 Соединитель задней стенки, высокий





			
PB-D-W2R0-00	1 kpl. = L+P 1 set = L+R	szary / gray / серый	stal steel
PB-D-W2R0-01	1 комп. = Л+П	biały / white / белый	сталь

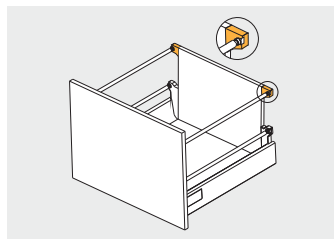

Mocowanie relingu do podwyższonej ścianki tylnej
 Back panel connector for rails, additional
 Соединитель задней стенки для рейлингов, дополнительная







			
PB-D-D2R0-00	1 kpl. = 2 szt. 1 set = 2 pcs	szary / gray / серый	tworzywo plastic пластмасса
PB-D-D2R0-01	1 комп. = 2 шт.	biały / white / белый	



Matryca do relingów
 Marking gauge for rails
 Матрица для рейлингов







			
PB-D-MATRYCA	1 kpl. = 1 szt. 1 set = 1 pcs 1 комп. = 1 шт.	szary gray серый	tworzywo plastic пластмасса



Znacznik do frontów
 Marking gauge for drawer front
 Маркер фасада







			
PB-D-ZNACZ-0	1 kpl. = 2 szt. 1 set = 2 pcs 1 комп. = 2 шт.	szary gray серый	ZnAl



Mocowanie do relingów
 Rail mounting
 Держатель рейлинга







			
PB-D-MHG04	1 kpl. = 2 szt. 1 set = 2 pcs 1 комп. = 2 шт.	szary gray серый	tworzywo plastic пластмасса

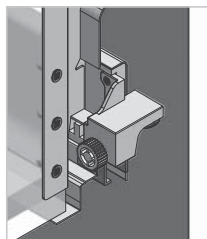

Rolka stabilizująca do szuflad push to open
 Drawer stabilizer for push to open drawers
 Стабилизирующий механизм для ящиков









			
PB-D-MBSTAB-00	1 kpl. = L+P 1 set = L+R 1 комп. = Л+П	szary gray серый	tworzywo plastic пластмасса



Modern Box

Komplet szuflady piekarnikowej niskiej
 Under oven drawer set, low
 Ящик под духовку, низкий



					
PB-D-KPL68-450-80	450	40	szary gray серый	lakier lacquer лак	stal steel сталь
PB-D-KPL68-500-80	500				
PB-D-KPL68-450-10	450		biały white белый		
PB-D-KPL68-500-10	500				

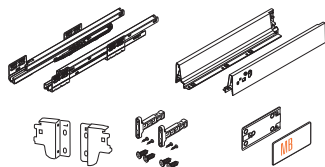

Modern Box

Komplet szuflady zlewozmywakowej niskiej
Under sink drawer – set
Ящик под мойку



PB-D-ZLE-450	450	40	szary gray серый	lakier lacquer лак	stal steel сталь
PB-D-ZLE-500	500				

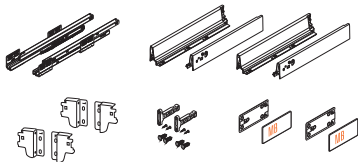

Modern Box

Komplet szuflady zlewozmywakowej U, niskiej
Under sink drawer U, low – set
Ящик под мойку U, низкий – компоненты



PB-D-ULE-500	500	40	szary gray серый	lakier lacquer лак	stal steel сталь
--------------	-----	----	------------------------	--------------------------	------------------------

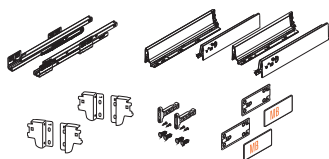



MB
MODERN BOX

Wkład CUSTOMI A regulowany
Adjustable cutlery organizer CUSTOMI A
Вкладыш CUSTOMI A с возможностью регулировки

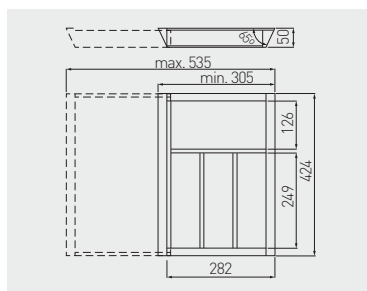

Do szuflad Modern Box i Axis PRO L = 450
For Modern Box or Axis PRO L = 450 mm
Подходит для ящиков Modern Box/Axis PRO L = 450 мм

Maksymalny wysuw = 535 mm
Maximum extension = 535 mm
Максимальное выдвижение = 535 мм

				
W-CUSTOMI-60L450	424 x 305	lakier bezbarwny matowy clearcoat matt surface лак матовый бесцветный	buk beech бук	drewno buk beech wood дерево бука



Wkład CUSTOMI BIS A regulowany
Adjustable cutlery organizer CUSTOMI BIS A
Вкладыш CUSTOMI BIS A с возможностью регулировки

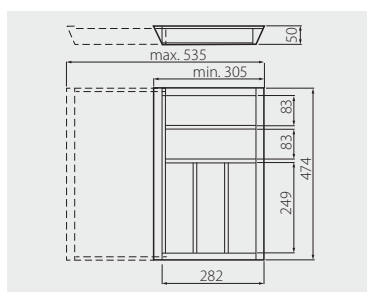

Do szuflad Modern Box i Axis PRO L = 500
For Modern Box or Axis PRO L = 500 mm
Подходит для ящиков Modern Box/Axis PRO L = 500 мм

Maksymalny wysuw = 535 mm
Maximum extension = 535 mm
Максимальное выдвижение = 535 мм

				
W-CUSTOMI-60L500	474 x 305	lakier bezbarwny matowy clearcoat matt surface лак матовый бесцветный	buk beech бук	drewno buk beech wood дерево бука



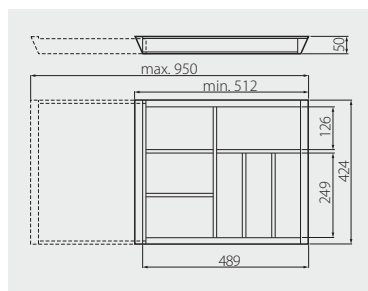

Wkład CUSTOMI B regulowany
Adjustable cutlery organizer CUSTOMI B
Вкладыш CUSTOMI B с возможностью регулировки



Do szuflad Modern Box i Axis PRO L = 450
For Modern Box or Axis PRO L = 450 mm
Подходит для ящиков Modern Box/Axis PRO L = 450 мм

Maksymalny wysuw = 950 mm
Maximum extension = 950 mm
Максимальное выдвигание = 950 мм

				
W-CUSTOMI-80L450	512 x 424	lakier bezbarwny matowy clearcoat matt surface лак матовый бесцветный	buk beech бук	drewno buk beech wood дерево бука



Wkład CUSTOMI BIS B regulowany
Adjustable cutlery organizer CUSTOMI BIS B
Вкладыш CUSTOMI BIS B с возможностью регулировки

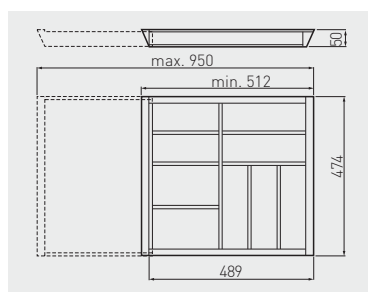

Do szuflad Modern Box i Axis PRO L = 500
For Modern Box or Axis PRO L = 500 mm
Подходит для ящиков Modern Box/Axis PRO L = 500 мм

Maksymalny wysuw = 950 mm
Maximum extension = 950 mm
Максимальное выдвигание = 950 мм





				
W-CUSTOMI-80L500	512 x 474	lakier bezbarwny matowy clearcoat matt surface лак матовый бесцветный	buk beech бук	drewno buk beech wood дерево бука

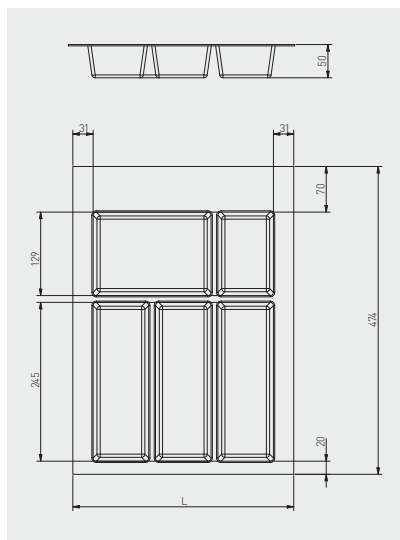

Wkład do szuflad Axispace
Cutlery organizer Axispace
Вставка в ящик Axispace

NEW



	 L mm		
WK-SZ-AS-400-10	400	biały white белый	tworzywo plastic пластмасса
WK-SZ-AS-500-10	500		
WK-SZ-AS-600-10	600		
WK-SZ-AS-800-10	800		
WK-SZ-AS-900-10	900	antracyt anthracite антрацит	
WK-SZ-AS-400-60	400		
WK-SZ-AS-500-60	500		
WK-SZ-AS-600-60	600		
WK-SZ-AS-800-60	800		
WK-SZ-AS-900-60	900		



Mata antypoślizgowa AXISPACE do szuflad
Anti-slip mat for drawers AXISPACE
Противоскользящий коврик для ящиков AXISPACE

NEW



	 L mm		
MA-MATA-1-10	5000 x 480	biały / white / белый	tworzywo plastic пластмасса
MA-MATA-1-60		antracyt / anthracite / антрацит	



Podpórka PELIKAN mata
Shelf support PELIKAN small
Полкодержатель PELIKAN маленький

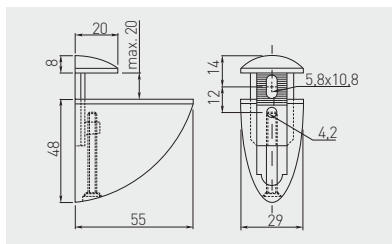

Code	Material	Material
PP-MP0055-01	chrom / chrome / хром	ZnAl
PP-MP0055-02	satyna / satin / сатин	
PP-MP0055-05	aluminium / aluminium / алюминий	
PP-MP0055-06	stal szcztokowana / brushed steel / шлифованная сталь	

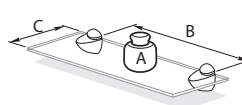

A - max. 8 kg / макс. 8 кг
B - 40 cm / 40 см
C - 20 cm / 20 см

Maksymalne obciążenie zależy od ilości wsporników i materiału, z jakiego wykonana jest półka.

The maximum load depends on the number of supports and material of which the shelf is made.

Максимальная нагрузка зависит от количества кронштейнов и материала, из которого изготовлена полка.

Podpórka PELIKAN średnia
Shelf support PELIKAN medium
Полкодержатель PELIKAN средний

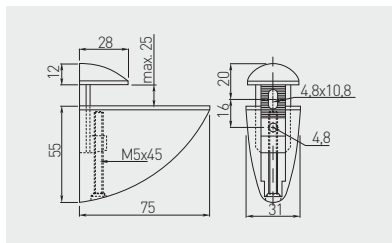

Code	Material	Material
PP-SP0075-01	chrom / chrome / хром	ZnAl
PP-SP0075-02	satyna / satin / сатин	
PP-SP0075-05	aluminium / aluminium / алюминий	
PP-SP0075-06	stal szcztokowana / brushed steel / шлифованная сталь	

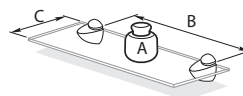

A - max. 10 kg / макс. 10 кг
B - 50 cm / 50 см
C - 25 cm / 25 см

Maksymalne obciążenie zależy od ilości wsporników i materiału, z jakiego wykonana jest półka.

The maximum load depends on the number of supports and material of which the shelf is made.

Максимальная нагрузка зависит от количества кронштейнов и материала, из которого изготовлена полка.

Podpórka PELIKAN duża Shelf support PELIKAN large Полкодержатель PELIKAN большой

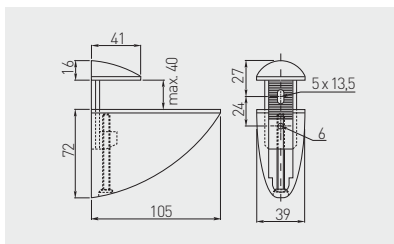

PP-DPO105-01	chrom / chrome / хром	ZnAl	
PP-DPO105-02	satyna / satin / сатин		
PP-DPO105-05	aluminium / aluminium / алюминий		
PP-DPO105-06	stal szcztokowana / brushed steel / шлифованная сталь		

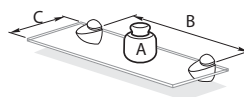

A - max. 12 kg / макс. 12 кг
B - 60 cm / 60 см
C - 30 cm / 30 см

Maksymalne obciążenie zależy od ilości wsporników i materiału, z jakiego wykonana jest półka.

The maximum load depends on the number of supports and material of which the self is made.

Максимальная нагрузка зависит от количества кронштейнов и материала, из которого изготовлена полка.

Podpórka GS02 Shelf support GS02 Полкодержатель GS02

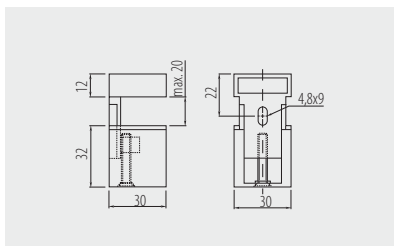

PP-00GS02-01	chrom / chrome / хром	ZnAl	
PP-00GS02-02	satyna / satin / сатин		
PP-00GS02-05	aluminium / aluminium / алюминий		
PP-00GS02-06	stal szcztokowana / brushed steel / шлифованная сталь		

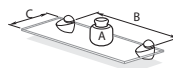

A - max. 4 kg / макс. 4 кг
B - 40 cm / 40 см
C - 20 cm / 20 см

Maksymalne obciążenie zależy od ilości wsporników i materiału, z jakiego wykonana jest półka.

The maximum load depends on the number of supports and material of which the self is made.

Максимальная нагрузка зависит от количества кронштейнов и материала, из которого изготовлена полка.

Podpórka GS03 Shelf support GS03 Полкодержатель GS03

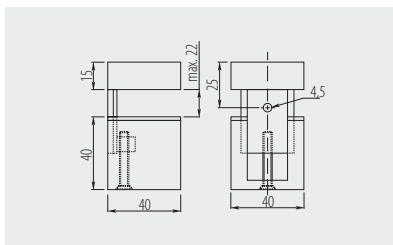

PP-00GS03-01	chrom / chrome / хром	ZnAl
PP-00GS03-02	satyna / satin / сатин	
PP-00GS03-05	aluminium / aluminium / алюминий	
PP-00GS03-06	stal szcztokowana / brushed steel / шлифованная сталь	

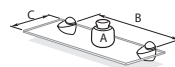

A - max. 6 kg / макс. 6 кг
B - 50 cm / см
C - 25 cm / см

Maksymalne obciążenie zależy od ilości wsporników i materiału, z jakiego wykonana jest półka.

The maximum load depends on the number of supports and material of which the self is made.

Максимальная нагрузка зависит от количества кронштейнов и материала, из которого изготовлена полка.

Podpórka GS04 Shelf support GS04 Полкодержатель GS04

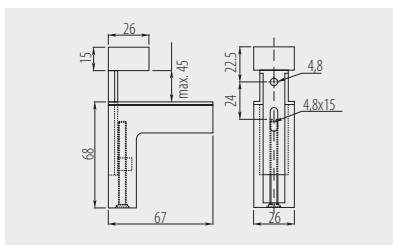

PP-00GS04-01	chrom / chrome / хром	ZnAl
PP-00GS04-02	satyna / satin / сатин	
PP-00GS04-05	aluminium / aluminium / алюминий	
PP-00GS04-06	stal szcztokowana / brushed steel / шлифованная сталь	

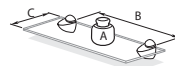

A - max. 10 kg / макс. 10 кг
B - 60 cm / см
C - 30 cm / см

Maksymalne obciążenie zależy od ilości wsporników i materiału, z jakiego wykonana jest półka.

The maximum load depends on the number of supports and material of which the self is made.

Максимальная нагрузка зависит от количества кронштейнов и материала, из которого изготовлена полка.

Podpórka A48 mocowana na wkręt
Shelf support A48 screw mounted
Полкодержатель А48 монтаж на винт

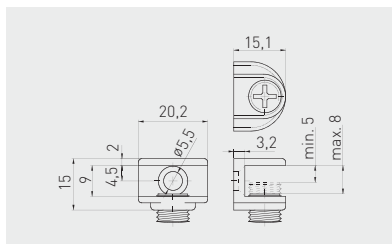

		
PP-GL-A48-01	chrom / chrome / хром	ZnAl



Podpórka B48 mocowana na wcisk
Shelf support B48 plug in
Полкодержатель В48 вставной

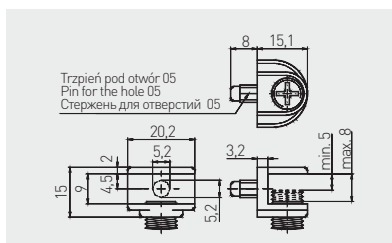

		
PP-GL-B48-01	chrom / chrome / хром	ZnAl



Podpórka CGP mocowana na wkręt
Shelf support CGP screw mounted
Полкодержатель CGP монтаж на винт

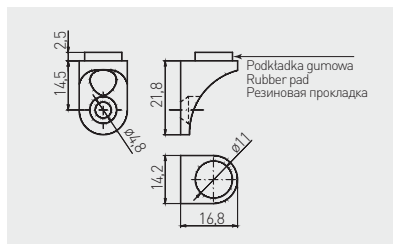

PP-GL-CGP-01	chrom / chrome / хром	ZnAl



Podpórka E410 mocowana na wcisk
Shelf support E410 plug in
Полкодержатель E410 вставной

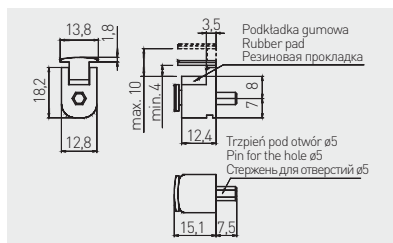

PP-GL-E410-01	chrom / chrome / хром	ZnAl





Podrórka SL3
Shelf support SL3
Полкодержатель SL3

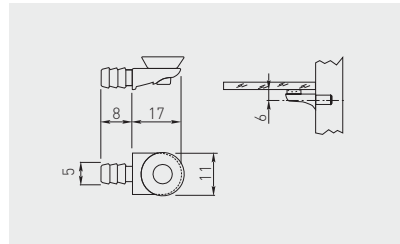

PP-SOL003-01T



chrom / chrome / хром



ZnAl, tworzywo / ZnAl, plastic / ZnAl, пластмасса



Podpórka SL12
Shelf support SL12
Полкодержатель SL12

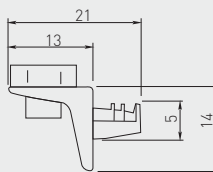

Grubość szkła max. 5 mm
Glass thickness max. 5 mm
Толщина стекла макс. 5 мм



PP-S0L012-01T



chrom / chrome / хром



ZnAl, tworzywo / ZnAl, plastic / ZnAl, пластмасса



Podpórka HS0
Shelf support HS0
Полкодержатель HS0

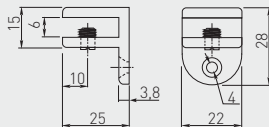

Grubość szkła max. 5 mm
Glass thickness max. 5 mm
Толщина стекла макс. 5 мм



PP-HS0006-01



chrom / chrome / хром



ZnAl



Podpórka HS2
Shelf support HS2
Полкодержатель HS2

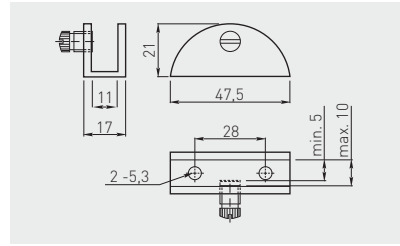

PP-HS2710-01	chrom / chrome / хром	ZnAl



Podpórka J63
Shelf support J63
Полкодержатель J63

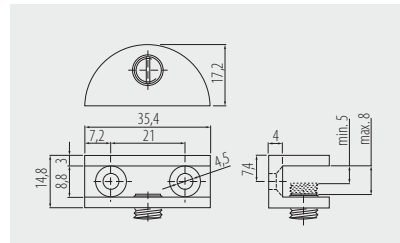



MC-J63-01	chrom / chrome / хром	ZnAl
MC-J63-05	stal szcztokowana / brushed steel / шлифованная сталь	

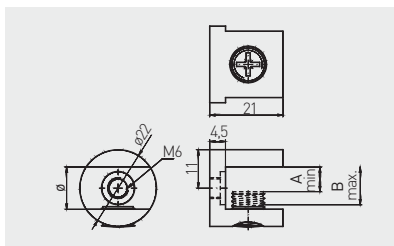

Podpórka J65
Shelf support J65
Полкодержатель J65



	\varnothing mm	A mm	B mm		
MC-J65-08-01	8	4	8	chrom / chrome / хром	ZnAl
MC-J65-08-05	8	4	8	stal szcztokowana / brushed steel / шлифованная сталь	
MC-J65-10-01	10	6	10	chrom / chrome / хром	
MC-J65-10-05	10	6	10	stal szcztokowana / brushed steel / шлифованная сталь	
MC-J65-12-01	12	7	11	chrom / chrome / хром	
MC-J65-12-05	12	7	11	stal szcztokowana / brushed steel / шлифованная сталь	



Podpórka J123
Shelf support J123
Полкодержатель J123

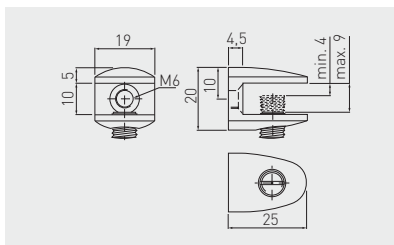

		
MC-J123-01	chrom / chrome / хром	ZnAl
MC-J123-05	stal szcztokowana / brushed steel / шлифованная сталь	



Podpórka K135
Shelf support K135
Полкодержатель K135

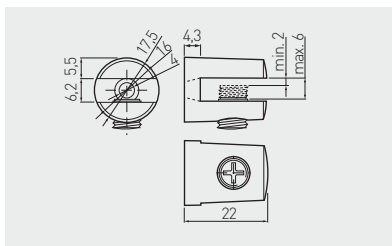

MC-K135-06-01	chrom / chrome / хром	ZnAl



Mocowanie J01
Fixture J01
Крепление J01

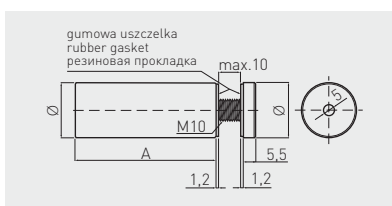





	mm	mm			
MC-J01A-12-01	12	16,5	chrom / chrome / хром	stal steel сталь	160
MC-J01A-12-06			stal szcztokowana / brushed steel / шлифованная сталь		
MC-J01A-16-01	16	25	chrom / chrome / хром	stal steel сталь	60
MC-J01A-16-06			stal szcztokowana / brushed steel / шлифованная сталь		

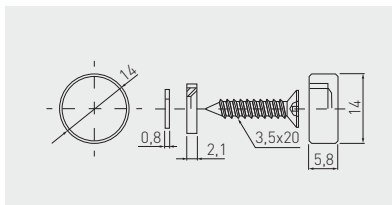

Мосowanie J04
 Fixture J04
 Крепление J04



	 mm			
MC-J04A2-14-01	14	chrom / chrome / хром	ZnAl	300
MC-J04A2-14-05	14	stal szcztokowana / brushed steel / шлифованная сталь		
MC-J04A2-18-01	18	chrom / chrome / хром		200
MC-J04A2-22-01	22	chrom / chrome / хром		100



Мосowanie J60
 Fixture J60
 Крепление J60

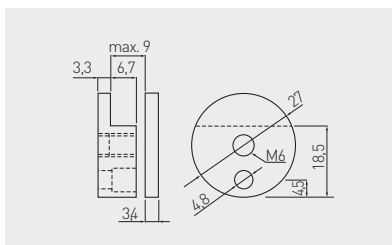

		
MC-J60A27-01	chrom / chrome / хром	ZnAl



Mocowanie J62
 Fixture J62
 Крепление J62

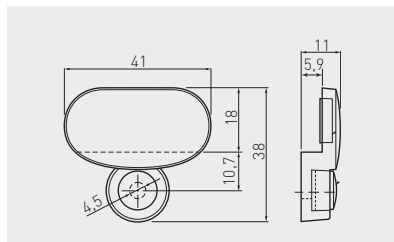

		
MC-J62-01	chrom / chrome / хром	ZnAl



Podrórka GL
 Shelf support GL
 Полкодержатель GL

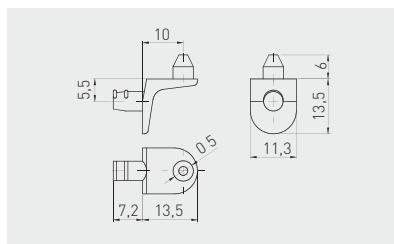

		
PP-GL-DR5-01	chrom / chrome / хром	ZnAl



Podrórka SAFETY
Shelf support SAFETY
Полкодержатель SAFETY

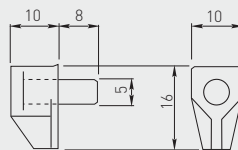

PP-SPL001-01	przeźroczysty transparent прозрачный	stal, tworzywo steel, plastic сталь, пластмасса



Podrórka MR-11
Shelf support pin MR-11
Полкодержатель MR-11

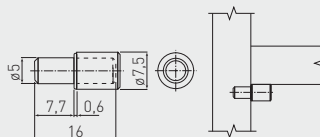

MR-ZSL011-01	z nakładką with plastic coating с накладкой	chrom / chrome / хром	stal / steel / сталь
MR-TDL011-01	bez nakładki without plastic coating без накладки		



Podpórka SMART
Shelf support SMART
Полкодержатель SMART

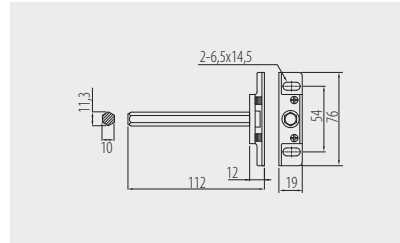

PP-SMART-000	srebrny / silver / серебристый	stal / steel / сталь



Podpórka CLEAR
Shelf support CLEAR
Полкодержатель CLEAR

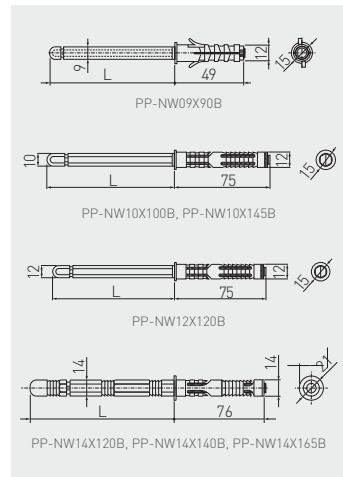

	mm	mm	kg			
PP-NW09X90B	9	90	10	brąz brown коричневый	stal steel сталь	200
PP-NW10X100B	10	110	15			
PP-NW10X145B	10	145	15			
PP-NW12X120B	12	120	15			100
PP-NW14X120B	14	120	25			
PP-NW14X140B	14	140	25			
PP-NW14X165B	14	165	25			



Podpórka LUK pod półkę
Shelf support bracket LUK
Полкодержатель LUK

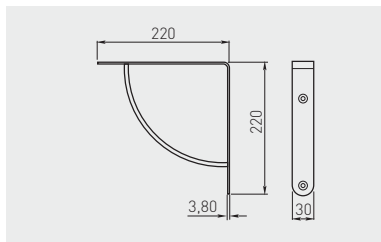

PP-LUK-00-01	30 / 2 szt. 30 / 2 pcs 30 / 2 шт.	chrom / chrome / хром	stal steel сталь
PP-LUK-00-02		satyna / satin / сатин	
PP-LUK-00-05		aluminium / aluminium / алюминий	



Podpórka WB-24 pod półkę
Shelf support bracket WB-24
Полкодержатель WB-24

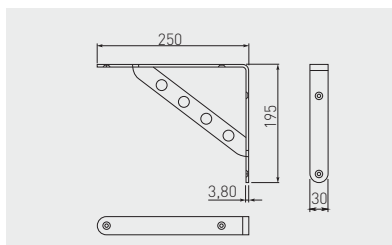

WB-073024-01	30 / 2 szt. 30 / 2 pcs 30 / 2 шт.	chrom / chrome / хром	stal / steel / сталь
WB-073024-06		stal szorstkowana / brushed steel / шлифованная сталь	



Podpórka WB-25 pod półkę
Shelf support bracket WB-25
Полкодержатель WB-25

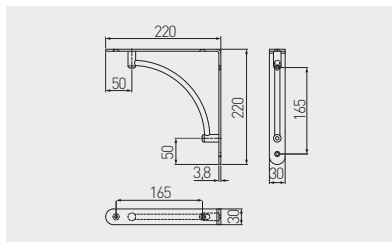

WB-073025-01	30 / 2 szt. 30 / 2 pcs	chrom / chrome / хром	stal / steel / сталь
WB-073025-06	30 / 2 шт.	stal szcztokowana / brushed steel / шлифованная сталь	



Podpórka WB-26 pod półkę
Shelf support bracket WB-26
Полкодержатель WB-26

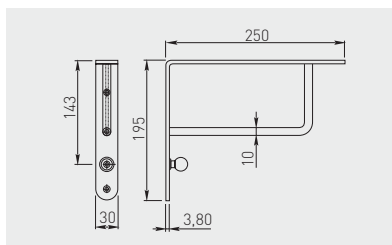

WB-073026-01	30 / 2 szt. 30 / 2 pcs	chrom / chrome / хром	stal / steel / сталь
WB-073026-06	30 / 2 шт.	stal szcztokowana / brushed steel / шлифованная сталь	



Podrórka WS12
Shelf support bracket WS12
Полкодержатель WS12

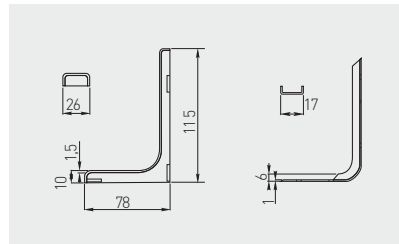

	 mm	 kg		
WB-WS-12-010	120	8 / 2 szt. 8 / 2 pcs 8 / 2 шт.	biały / white / белый	tworzywo plastic пластмасса



Podrórka WS18
Shelf support bracket WS18
Полкодержатель WS18

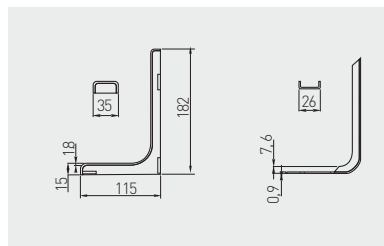

	 mm	 kg		
WB-WS-18-010	180	9,5 / 2 szt. 9,5 / 2 pcs 9,5 / 2 шт.	biały / white / белый	tworzywo plastic пластмасса
WB-WS-18-020	180		czarny / black / чёрный	
WB-WS-18-060	180		szary / gray / серый	



Podpórka WS24
Shelf support bracket WS24
Полкодержатель WS24

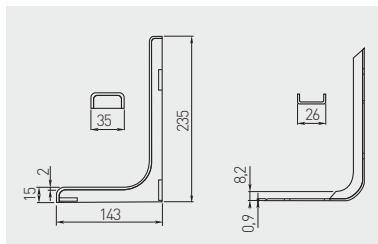



					
WB-WS-24-010		240	11 / 2 szt.	biały / white / белый	tworzywo plastic пластмасса
WB-WS-24-020		240	11 / 2 pcs 11 / 2 шт.	czarny / black / чёрный	



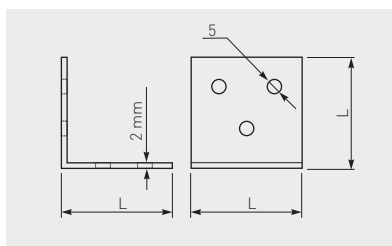





Kątownik FS01 szeroki
Angle bracket FS01
Широкий крепежный уголок FS01

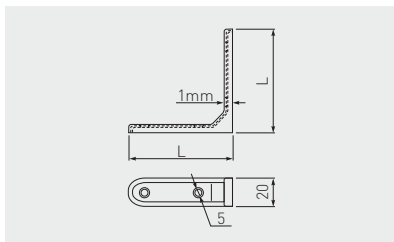

					
KW-FS0125-01		25 x 25 x 24	chrom / chrome / хром	stal / steel / сталь	1500
KW-FS0140-01		40 x 40 x 40			400





Kątownik FS03 wzmocniony
 Angle bracket FS03 reinforced
 Усиленный крепежный уголок FS03

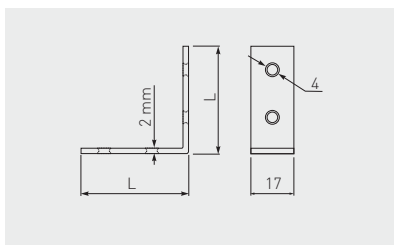

	 L mm			
KW-FS0335-01	35 x 35 x 20	chrom / chrome / хром	stal / steel / сталь	1300
KW-FS0350-01	50 x 50 x 20			700
KW-FS0375-01	75 x 75 x 20			400

Kątownik FS04 standardowy
 Angle bracket FS04 standard
 Стандартный крепежный уголок FS04



	 L mm			
KW-FS0425-03	25 x 25 x 17	mosiądz / brass / латунь	stal / steel / сталь	1500
KW-FS0450-03	50 x 50 x 17			600

Kątownik FS06 narożnikowy
 Corner bracket FS06
 Угловой крепежный уголок FS06

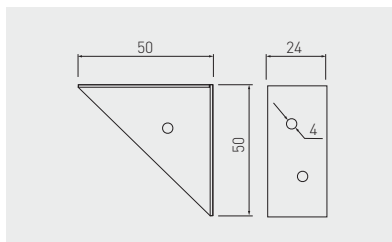

KW-FS0650-01

50 x 50 x 24

chrom / chrome / хром

stal / steel / сталь



Narożnik MONT pojedynczy
 Corner bracket MONT single
 Одинарный уголок MONT

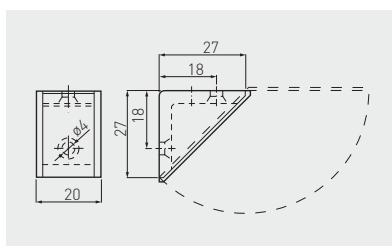

PP-PMONT0M-01*

biały / white / белый

PP-PMONT0M-07*

ciemny brąz / dark brown / темно-коричневый

PP-PMONT0M-08*

szary / gray / серый

PP-PMONT0M-22*



kość stoniowa / ivory / слоновая кость

tworzywo
plastic
пластмасса

* Produkt dostępny na indywidualne zamówienie / Available for special orders / Товар доступен под заказ

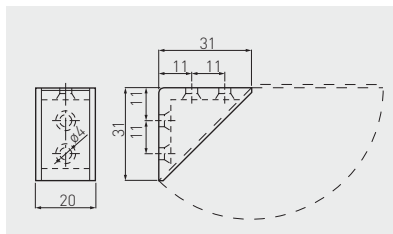
Narożnik MONT podwójny Corner bracket MONT double Двойной уголок MONT



		
PP-PMONT0D-22*	kość stoniowa / ivory / слоновая кость	tworzywo plastic / пластмасса



* Produkt dostępny na indywidualne zamówienie / Available for special orders / Товар доступен под заказ

Narożnik NARS pojedynczy Corner bracket NARS single Одинрный уголок NARS

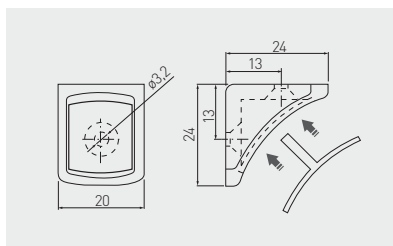

		
PM-NAR1003-512	kość stoniowa / ivory / слоновая кость	tworzywo plastic / пластмасса
PM-NAR1003-645	szary / gray / серый	
PM-NAR1003-677*	czarny / black / чёрный	
PM-NAR1003-680	biały / white / белый	
PM-NAR1003-695*	srebrny / silver / серебристый	
PM-NAR1003-725*	jasny brąz / light brown / светло-коричневый	
PM-NAR1003-728*	beż / beige / бежевый	
PM-NAR1003-732*	ciemny brąz / dark brown / темно-коричневый	
PM-NAR1003-771*	olcha / alder / ольха	



* Produkt dostępny na indywidualne zamówienie / Available for special orders / Товар доступен под заказ

Narożnik NARS podwójny Corner bracket NARS double Двойной уголок NARS

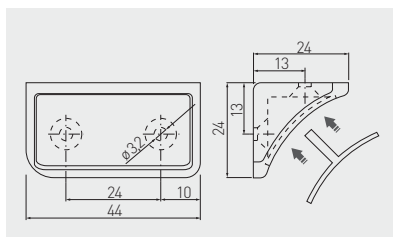

PM-NAR1004-512	kość stonowa / ivory / слоновая кость	tworzywo plastic пластмасса
PM-NAR1004-645	szary / gray / серый	
PM-NAR1004-677*	czarny / black / чёрный	
PM-NAR1004-680	biały / white / белый	
PM-NAR1004-695*	aluminium / aluminium / алюминий	
PM-NAR1004-725*	jasny brąz / light brown / светло-коричневый	
PM-NAR1004-728*	beż / beige / бежевый	
PM-NAR1004-732*	ciemny brąz / dark brown / темно-коричневый	



* Produkt dostępny na indywidualne zamówienie / Available for special orders / Товар доступен под заказ

Stabilizator ścianki tylnej Rear stabilizer Стабилизатор задней стенки

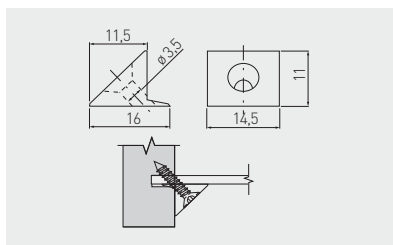





WZ-SCTYLPR-WK	z wkrętem 3,5 x 20 with screw 3,5 x 20 с шурупом 3,5 x 20	transparentna transparent прозрачный	tworzywo plastic пластмасса
WZ-SCTYLPR-BWK	bez wkręta without screw без шурупа		

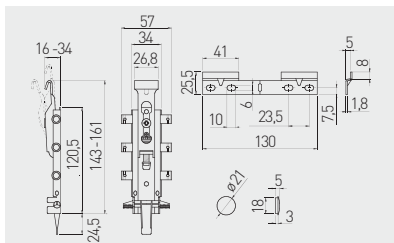

Zawieszka niewidoczna FORCE
Invisible kitchen hanger FORCE
Скрытый навес FORCE





			
ZK-FORCE-KPL	100 / 2 szt. 100 / 2 pcs 100 / 2 шт.	srebrny / silver / серебристый	ZnAl, stal / ZnAl, steel / ZnAl, сталь

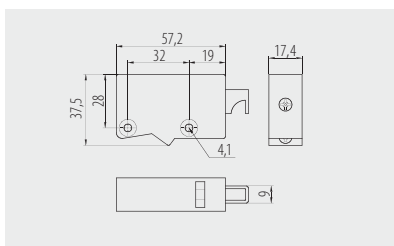

Zawieszka kuchenna R0 z regulacją
Kitchen hanger R0 adjustable
Навес кухонный R0 с регулировкой





			
ZK-ZAW-R0-10	50 / 2 szt. 50 / 2 pcs	biały / white / белый	stal, tworzywo steel, plastic
ZK-ZAW-R0-30	50 / 2 шт.	brąz / brown / коричневый	сталь, пластмасса

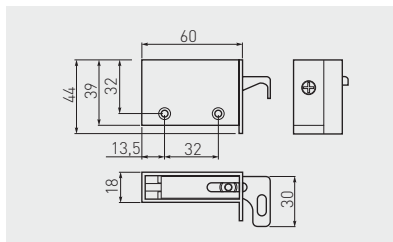

Zawieszka kuchenna R1
Kitchen hanger R1
Навес кухонный R1







			
ZK-R1-KPL-10	90 / 2 szt. 90 / 2 pcs 90 / 2 шт.	biały / white / белый	stal, tworzywo steel, plastic сталь, пластмасса

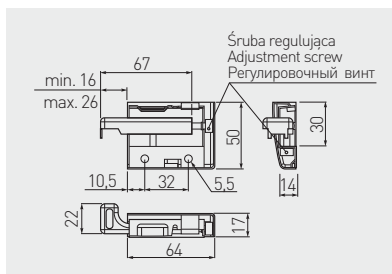

Zawieszka kuchenna STRONG
Kitchen hanger STRONG
Навес кухонный STRONG







				
ZK-STRONG-KPL	130 / 2 szt. 130 / 2 pcs 130 / 2 шт.	1 kpl. = L+P 1 set = L+R 1 комп. = Л+П	srebrny silver серебристый	stal, tworzywo steel, plastic сталь, пластмасса

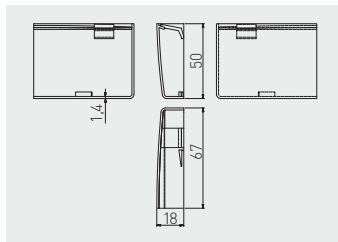

Zaślepka do zawieszki STRONG
Hanger caps STRONG
Заглушки для навесов STRONG



			
ZK-ZAS-KPL-10	1 kpl. = L+P 1 set = L+R 1 комп. = Л+П	biały / white / белый	
ZK-ZAS-KPL-31		ciemny brąz / dark brown / темно-коричневый	
ZK-ZAS-KPL-32		jasny brąz / light brown / светло-коричневый	
		tworzywo plastic пластмасса	



Listwa montażowa
Mounting strip
Монтажная планка

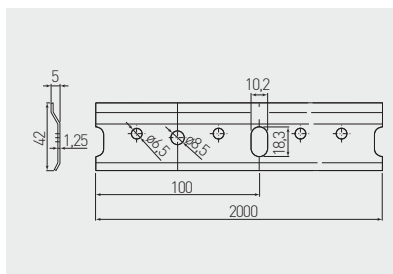

			
LO-M2M-00-125	2000	ocynk galvanized гальваника	stal steel сталь



Złącze do blatów śrubowe
Concealed worktop connector
Стяжка для столешниц

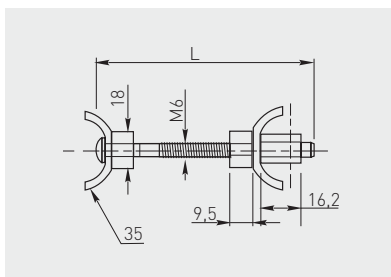

	 L mm		
EM-SBL060-01	60	chrom / chrome / хром	stal, tworzywo steel, plastic сталь, пластмасса
EM-SBL100-01	100		
EM-SBL150-01	150		



Złącze mimośrodowe do półek
Eccentric connecting fitting for shelves
Эксцентриковая стяжка для полок

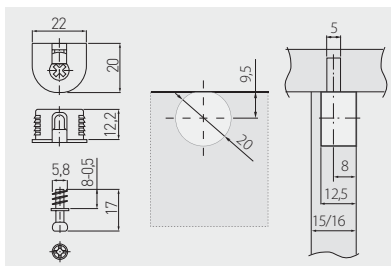

	 mm			
MM-FI20X6X7-PL10	20	trzpień 6 x 7 mm dowel 6 x 7 mm штифт 6 x 7 мм	biały / white / белый	ZnAl, tworzywo ZnAl, plastic ZnAl, пластмасса
MM-FI20X6X7-PL20			czarny / black / чёрный	
MM-FI20X6X7-PL30			brąz / brown / коричневый	
MM-FI20X6X7-PL80			szary / gray / серый	
MM-FI20X6X7-ZN			srebrny / silver / серебристый	



Szybkozłącze Threaded sleeve, with internal thread Стяжки



SZ-005-00-01T
SZ-008-00-01T

SZ-005-00-01-A
SZ-008-00-01-A

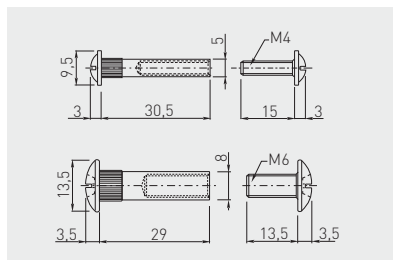







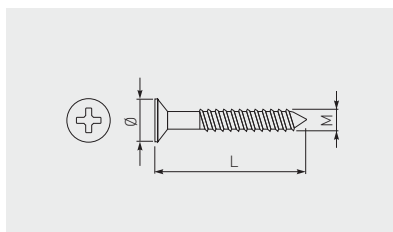

		 mm		
SZ-005-00-01T		5	chrom / chrome / хром	stal / steel / сталь
SZ-005-00-01-A				
SZ-008-00-01T		8		
SZ-008-00-01-A				



Wkręt do drewna Screw for wood Мебельные метизы



		 mm		
WK-D0320-001*		3 x 20	chrom chrome хром	stal steel сталь
WK-D0325-001*		3 x 25		
WK-D0330-001*		3 x 30		
WK-D0416-001		4 x 16		
WK-D0425-001*		4 x 25		

		 mm		
WK-D0430-001		4 x 30	chrom chrome хром	stal steel сталь
WK-D0440-001*		4 x 40		
WK-D0460-001*		4 x 60		
WK-D3516-001		3,5 x 16		
WK-D3530-001		3,5 x 30		

- * Produkt dostępny na indywidualne zamówienie
- * Available for special orders
- * Товар доступен под заказ



Mimośród F115X12mm
 Eccentric connecting fitting F115X12mm
 Эксцентрик F115X12mm

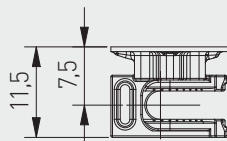



	 mm		
WK-CAM-15-12-D	Ø15 x 12	srebrny / silver / серебряный	ZnAl

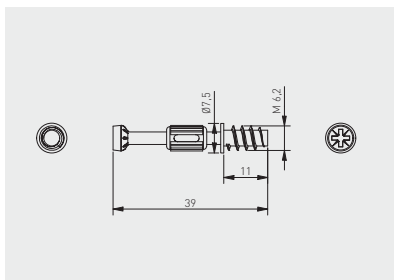

Trzpień do mimośrodu
 Bolt for eccentric connecting fitting
 Шток эксцентрика



			
WK-DOW63X45B-D	6,3 x 45	srebrny, pomarańczowy silver, orange серебряный, апельсин	stal, tworzywo steel, plastic сталь, пластмасса
WK-DOW63X39-D	6,3 x 39		
WK-DOW63X35B-D	6,3 x 35		
WK-DOW63X31G-D	6,3 x 31		



Konfirmat*
 Conformat screw*
 Конфирмат*

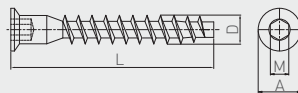

		L	D	A	M
WK-CF6450-01	6,4 x 50	50	6,4	9,5	4
WK-CF0750-01	7 x 50	50	7	10	4



WK-CF6450-01	chrom / chrome / хром	stal / steel / сталь
WK-CF0750-01		



* Produkt dostępny na indywidualne zamówienie / Available for special orders / Товар доступен под заказ

Magnes MENSA
 Magnetic catch MENSA
 Магнит MENSA

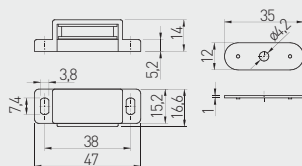





MG-MENSA-010	biały / white / белый	stal, tworzywo steel, plastic сталь, пластмасса
MG-MENSA-030	brąz / brown / коричневый	

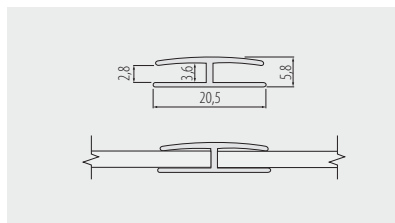

Profil meblowy PFM – typ H
 Furniture edge profile PFM – type H
 Мебельный профиль PFM – тип H



	 L mm		
PM-PFMH51-10*	2000	ciemny brąz / dark brown / темно-коричневый	tworzywo plastic пластмасса
PM-PFMH61-10*	2000	ciemny mahoń / dark mahogany / темное красное дерево	
PM-PFMH50-24*	2400	biały / white / белый	
PM-PFMH50-25*	2500	biały / white / белый	
PM-PFMH55-25*	2500	czarny / black / чёрный	
PM-PFMH64-25*	2500	mahoń / mahogany / красное дерево	



* Produkt dostępny na indywidualne zamówienie / Available for special orders / Товар доступен под заказ

Listwa ozdobna płaska
Flat decorative strip
Плоская декоративная планка



Taśma samoprzylepna
Self-adhesive tape
Самоклеящаяся лента

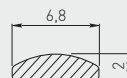

	 L mm		
LO-00-00-001*	2000	chrom / chrome / хром	tworzywo plastic пластмасса
LO-00-00-003	2000	mosiądz / brass / латунь	



* Produkt dostępny na indywidualne zamówienie / Available for special orders / Товар доступен под заказ

Listwa boczna 38
Worktop edging strip 38
Торцевая планка 38

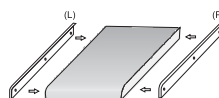

Do blatów o grubości 38 mm
For worktops 38 mm thick
Для столешниц толщиной 38 мм

		 L mm		
LMB-BOCZ38L-05	lewa / left / левая	600	aluminium aluminium алюминий	aluminium aluminium алюминий
LMB-BOCZ38L-20M				
LMB-BOCZ38P-05	prawa / right / правая			
LMB-BOCZ38P-20M				



Listwa kątowa 38
Worktop angle edging strip 38
Угловая планка 38

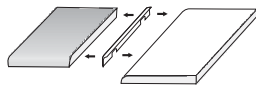

Do blatów o grubości 38 mm
For worktops 38 mm thick
Для столешниц толщиной 38 мм



LMB-KAT38-05



600



aluminium / aluminium / алюминий
czarny / black / чёрный



aluminium
aluminium
алюминий



* Produkt dostępny na indywidualne zamówienie / Available for special orders / Товар доступен под заказ



Listwa szczelinowa 38
Worktop joining strip 38
Щелевая планка 38

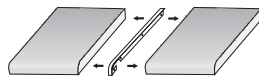

Do blatów o grubości 38 mm
For worktops 38 mm thick
Для столешниц толщиной 38 мм

	 L mm		
LMB-SZCZ38-05	600	aluminium / aluminium / алюминий	aluminium
LMB-SZCZ38-20M		czarny / black / чёрный	aluminium aluminium алюминий



Drażek owalny
Oval wardrobe rail
Овальная труба для гардероба

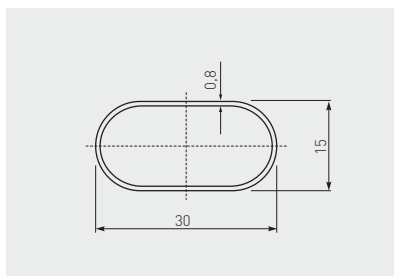

	 L mm		
RR-CH-OW-000	3000	chrom / chrome / хром	stal / steel / сталь



Mocowanie RDR do drążka owalnego
 RDR mounting bracket for oval wardrobe rail
 Крепление RDR для овальной трубы

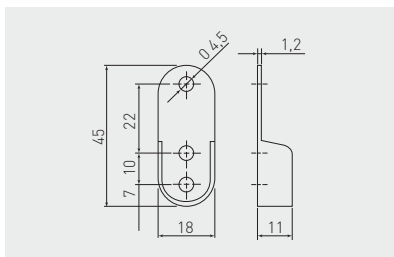

MR-RDR0-0000



chrom / chrome / хром



stal / steel / сталь



Uchwyt WP-28 do rury owalnej
 WP-28 angle bracket for oval rail
 Крепление дистанционное для овальной трубы WP-28

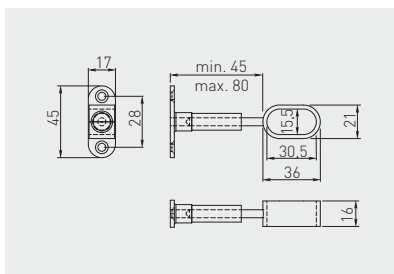

MR-WP-028-01



chrom / chrome / хром





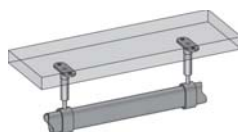



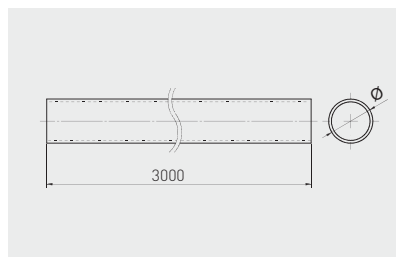





ZnAl



Drążek okrągły
Round wardrobe rail
Мебельная штанга



		 mm	 mm	 mm		
RR-161030H01		16	1	3000	chrom chrome хром	stal steel сталь
RR-161230H01		16	1,2			
RR-250730H01		25	0,7			
RR-250830H01		25	0,8			
RR-250930H01		25	0,9			

		 mm	 mm	 mm		
RR-251030H01		25	1	3000	chrom chrome хром	stal steel сталь
RR-401230H01*		40	1,2			
RR-501030H01		50	1			
RR-501230H01		50	1,2			



* Produkt dostępny na indywidualne zamówienie / Available for special orders / Товар доступен под заказ

Mocowanie R-25 do drążka okrągłego
R-25 mounting bracket for round rail
Крепление R-25 для трубы

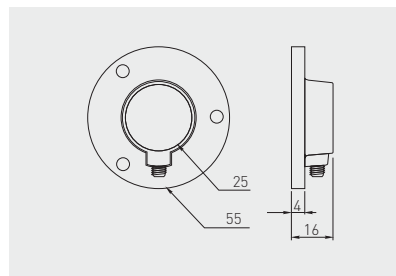

		 mm		
MR-RS025-001		25	chrom / chrome / хром	stal / steel / сталь



Монтаж R-50 до дрэжка круглого
R-50 mounting bracket for round rail
Крепление R-50 для трубы

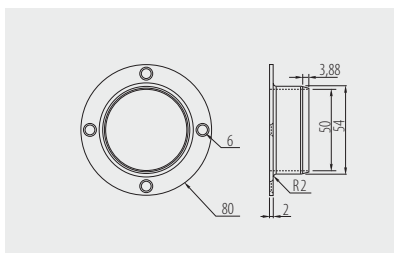

	 mm		
MR-R0050-001	50	chrom / chrome / хром	stal / steel / сталь



Монтаж PZ-2 dolne до дрэжка круглого
PZ-2 bottom mounting bracket for round rail
Нижнее крепление PZ-2 для трубы

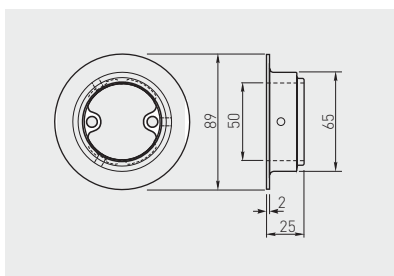

	 mm		
MR-WPZ002-01	50	chrom / chrome / хром	stal / steel / сталь



Pierścień mocujący PZ-3
Mounting ring PZ-3
Крепёжное кольцо PZ-3

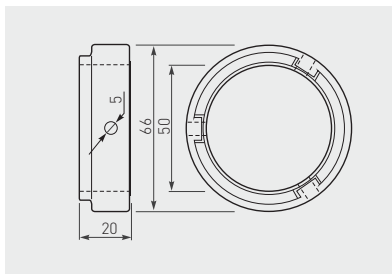

	 mm		
MR-WPZ003-01	50	chrom / chrome / хром	ZnAl



Uchwyt WP-10 dystansowy, regulowany
WP-10 support bracket, adjustable
Регулируемый кронштейн WP-10

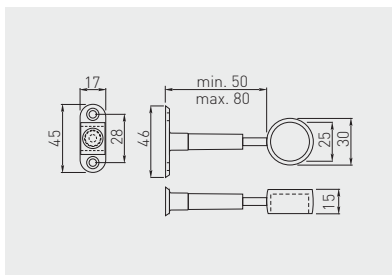

	 mm		
MR-WP-010-01	25	chrom / chrome / хром	ZnAl



Uchwyt WP-11 dystansowy, regulowany z zaślepką
 WP-11 support bracket, adjustable with cover
 Регулируемый кронштейн WP-11 с заглушкой

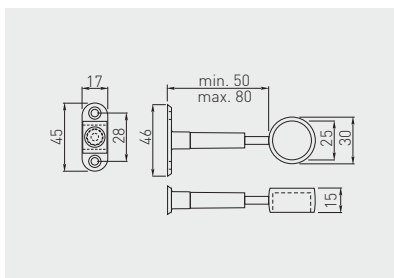

	 mm		
MR-WP-011-01	25	chrom / chrome / хром	ZnAl



Uchwyt THA-12 dystansowy, przelotowy
 THA-12 support bracket
 Опорный кронштейн THA-12 сквозной

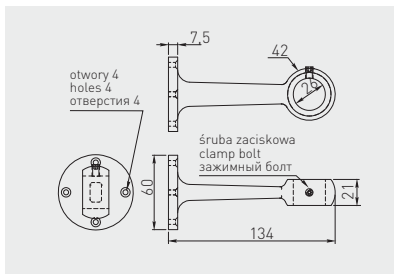

	 mm		
MR-THA12-001	25	chrom / chrome / хром	ZnAl



Uchwyt THB-12 dystansowy
 THB-12 support bracket
 Опорный кронштейн THB-12

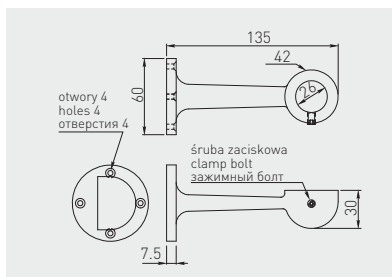

MR-THB12-001

25

chrom / chrome / хром

ZnAl



Łącznik WP-13
 WP-13 connector
 Соединитель WP-13

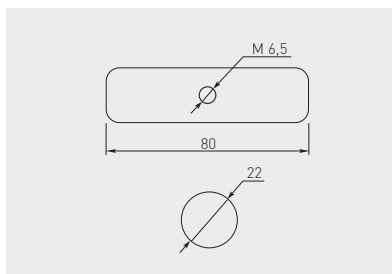

MR-WP013-001

ocynk / galvanized / гальваника

ZnAl



Złącze TH-5 dwuramienne
 TH-5 connector
 Муфта TH-5 двухраструбная

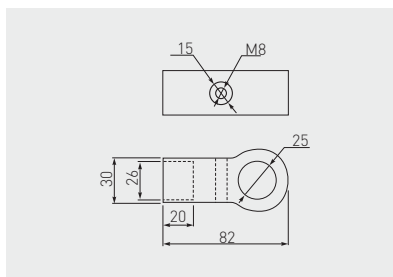

MR-TH005-001	25	chrom / chrome / хром	ZnAl
--------------	----	-----------------------	------



Złącze TH-16 dwuramienne
 TH-16 connector
 Муфта двухраструбная TH-16

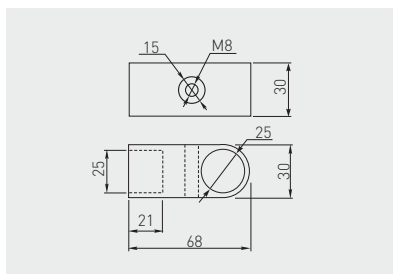

MR-TH016-001	25	chrom / chrome / хром	ZnAl
--------------	----	-----------------------	------



Złącze TH-4 dwuramienne typ T
 TH-4 connector type T
 Муфта TH-4 двухраструбная тип T

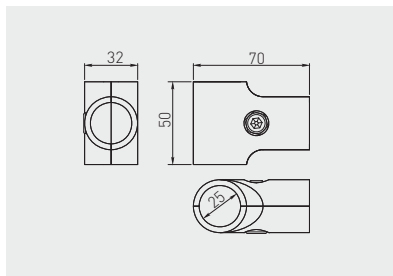

	 mm		
MR-TH004-001	25	chrom / chrome / хром	ZnAl



Zestaw złączy TH-18 typ L
 TH-18 connector type L
 Набор муфт TH-18 тип L

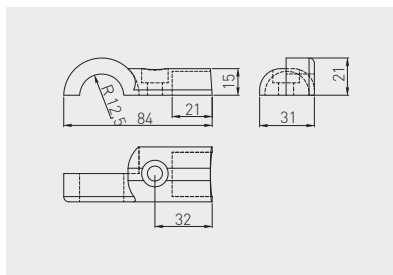

Możliwość uzyskania różnych położeń połączenia
 The possibility of obtaining various positions of connection
 Возможность получения разных положений соединения

		 mm		
MR-TH018-KPL	prawy / lewy right / left правый / левый	25	chrom / chrome / хром	ZnAl



Zestaw złączy T-18 typ T
T-18 connectors set type T
Набор муфт ТН-18 тип Т

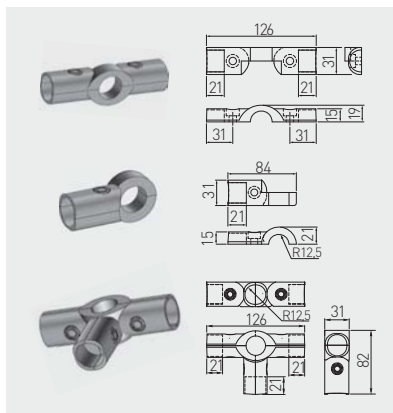

MR-T1824-KPL



mm

25



chrom / chrome / хром



ZnAl

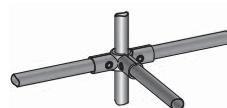

Zestaw złączy TH-24
TH-24 connectors set
Набор муфт ТН-24

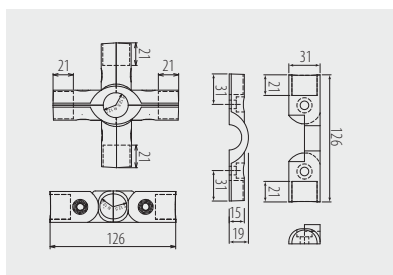

MR-TH024-KPL



mm

25



chrom / chrome / хром



ZnAl



Złącze TH-11 zawiasowe
TH-11 hinge connector
Муфта шарнирная TH-11

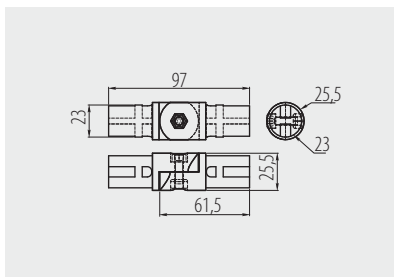

MR-TH011-001

chrom / chrome / хром

ZnAl

x 200



Możliwość dostosowania kąta złączy do założonego położenia (do 180°)

The possibility of adjustment of angle connector arms to the desired position (up to 180°)

Возможность регулировки угла стыковки соединителей к заданному положению [180°]

Złącze TH-9
TH-9 connector
Муфта TH-9

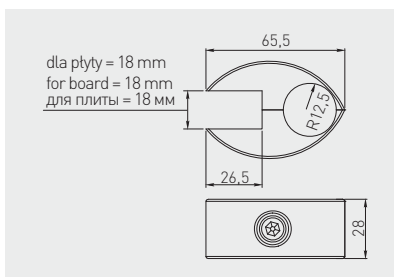

MR-TH009-001

chrom / chrome / хром

ZnAl

BOARD

WOOD

GLASS

x 120



Zalecana grubość szkła z użyciem wkładek: 4-8 mm

Recommended glass thickness with inserts: 4-8 mm

Рекомендуемая толщина стекла с использованием вкладышей: 4-8 мм

Złącze TH-10 dwustronne
TH-10 connector
Муфта TH-10 двухсторонняя

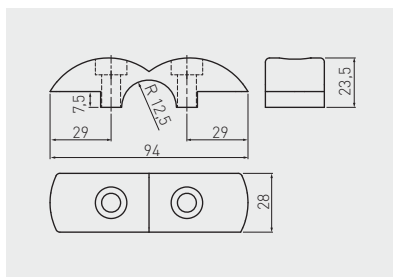

MR-TH010-001

chrom / chrome / хром

ZnAl



Zalecana grubość szkła z użyciem wkładek: 4-8 mm
Recommended glass thickness with inserts: 4-8 mm
Рекомендуемая толщина стекла с использованием вкладышей: 4-8 мм

Zestaw złączy TH-35
TH-35 set of connectors
Набор муфт TH-35

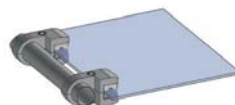
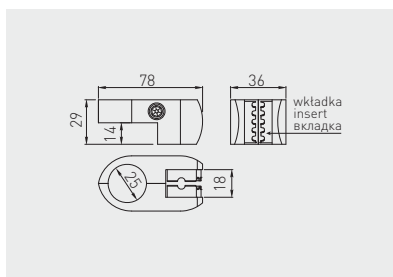

MR-TH035-KPL

25

chrom / chrome / хром

ZnAl



Zalecana grubość szkła z użyciem wkładek: 4-8 mm
Recommended glass thickness with inserts: 4-8 mm
Рекомендуемая толщина стекла с использованием вкладышей: 4-8 мм

Złącze WP-14 dwustronne
WP-14 connector
Муфта WP-14 двухсторонняя

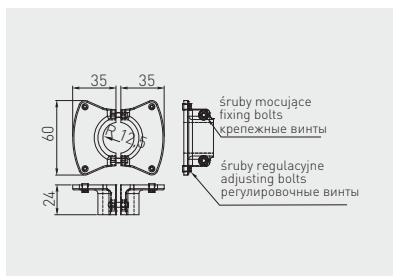

	 mm		
MR-WP-14-KPL	25	chrom / chrome / хром	ZnAl

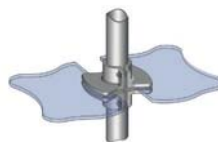

Złącze WP-15
WP-15 connector
Муфта WP-15

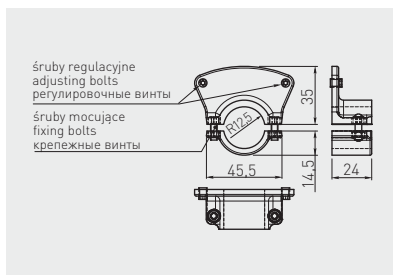

	 mm		
MR-WP-15-KPL	25	chrom / chrome / хром	ZnAl

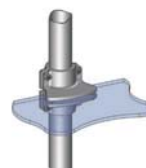

Złącze TH-1 równoległe
 TH-1 connector parallel
 Муфта TH-1 равнопроходная

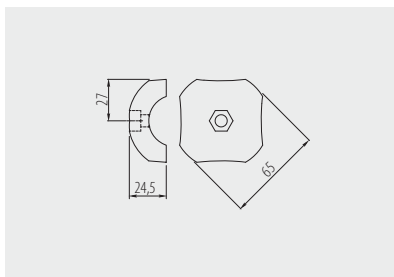

		
MR-TH001-01	chrom / chrome / хром	ZnAl



Złącze TH-2 potrójne
 TH-2 connector three-way
 Муфта TH-2 тройная

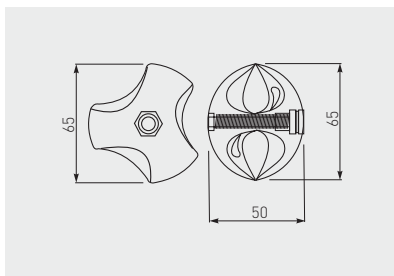

			
MR-TH002-L01	lewy / left / левый	chrom / chrome / хром	ZnAl
MR-TH002-P01	prawy / right / правый		



Złącze TH-18 podwójne
TH-18 double connector
Муфта TH-18 двойная

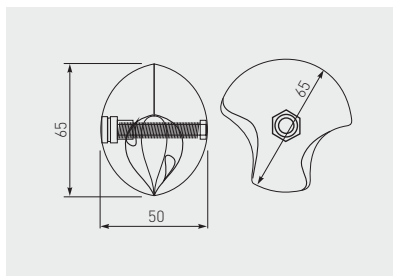

			
MR-TH018-L01	lewy / left / левый	chrom / chrome / хром	ZnAl
MR-TH018-P01	prawy / right / правый		



Zaślepka okrągła
Round end cap
Круглая заглушка

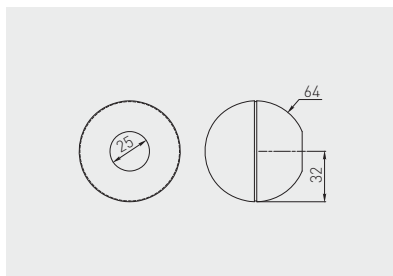

	 mm		
MR-THQZ1-001	25	chrom / chrome / хром	ZnAl



Zaślepka TH-19
TH-19 end cap
Заглушка TH-19

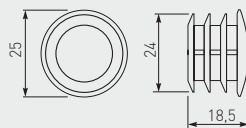

	 mm		
MR-TH019-001	25	chrom / chrome / хром	ZnAl



Stopka plastikowa zewnętrzna
Plastic end cap
Внешняя ножка, пластмассовая

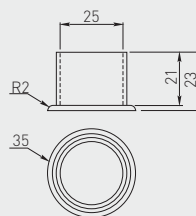

	 mm		
MR-TH019-003	25	czarny black чёрный	tworzywo plastic пластмасса



Uchwyt THA-48 z przysawką
 THA-48 handle with suction cup
 Крепление THA-48 с присоской

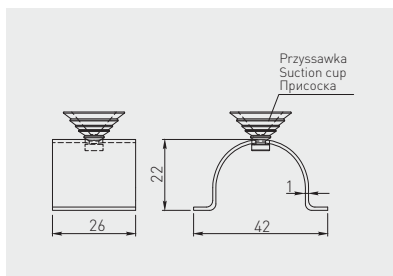

	 mm		
MR-TH048-001	25	chrom chrome хром	stal, tworzywo steel, plastic сталь, пластмасса

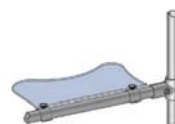

Mocowanie PZ-6 górne, rozporowe
 PZ-6 expandable end support bracket
 Верхнее крепление PZ-6

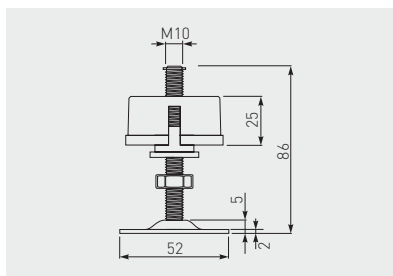

	 mm		
MR-WPZ006-01	50	chrom / chrome / хром	stal, tworzywo / steel, plastic / сталь, пластмасса



Uchwyt do relingu prosty
 Rail support
 Ручка для рейлинга прямая

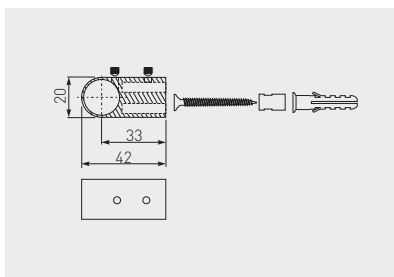

MR-WP2802-01



16



chrom / chrome / хром



ZnAl



Zaślepka do relingu prosta
 End cap
 Заглушка для рейлинга прямая

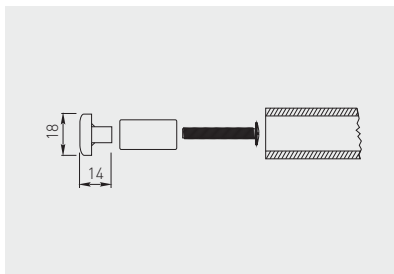

MR-WP2815-01



16



chrom / chrome / хром



ZnAl



Uchwyt do relingu
Rail support
Ручка для рейлинга

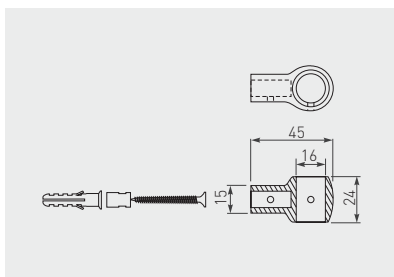

	 mm		
MR-WP2804-01	16	chrom / chrome / хром	ZnAl



Zaślepka do relingu
End cap
Заглушка для рейлинга

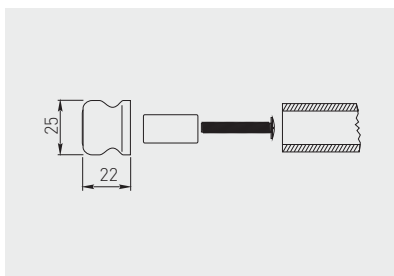

	 mm		
MR-WP2806-01	16	chrom / chrome / хром	ZnAl, tworzywo / ZnAl, plastic / ZnAl, пластмасса



Łącznik do relingu
 Rail connector
 Соединитель для рейлинга

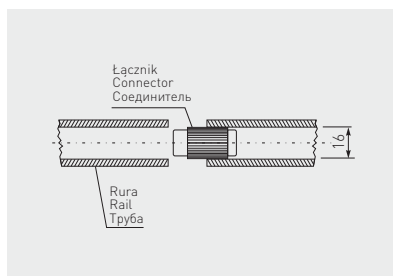

MR-WP2807-20	16 mm	czarny / black / чёрный	tworzywo / plastic / пластмасса



Zaślepka do relingu z gwintem
 End cap with thread for rails
 Заглушка для рейлинга с резьбой

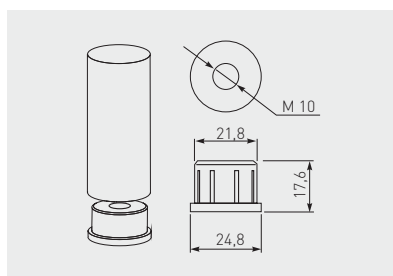

MR-WP2023-01	chrom / chrome / хром	ZnAl



Haczyki do relingu PS1
 Hooks for rails PS1
 Крючки для рейлінга PS1

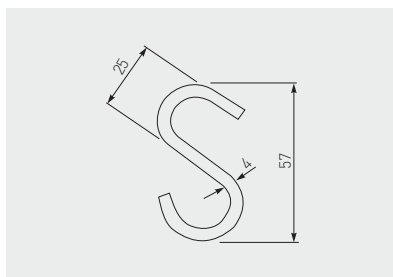

	 mm		
MR-WPS01-001	16	chrom / chrome / хром	stal / steel / сталь



Haczyki do relingu PS3
 Hooks for rails PS3
 Крючки для рейлінга PS3

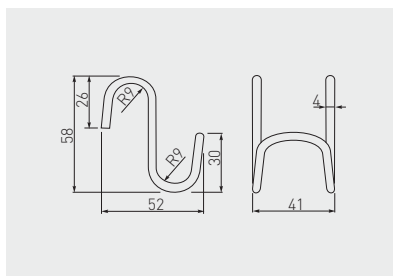





	 mm		
MR-WPS03-001	16	chrom / chrome / хром	stal / steel / сталь

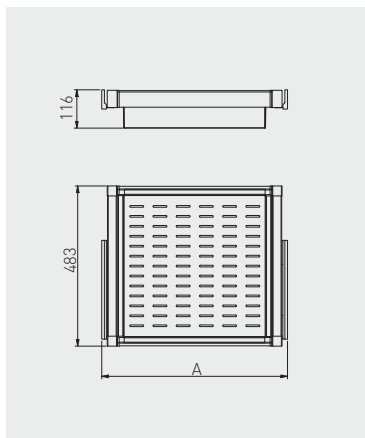

Kosz metalowy ELITE
 Metal basket ELITE
 Металлическая корзина ELITE





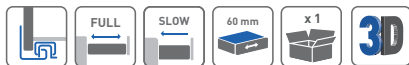

	A min./max.				
WG-KOSZM60-10	560 - 618	pełny full полное	biały white белый	stal, tworzywo steel, plastic сталь, пластмасса	
WG-KOSZM70-10	660 - 718				
WG-KOSZM80-10	760 - 818				
WG-KOSZM90-10	860 - 918				
WG-KOSZM60-60	560 - 618				antracyt anthracite антрацит
WG-KOSZM70-60	660 - 718				
WG-KOSZM80-60	760 - 818				
WG-KOSZM90-60	860 - 918				

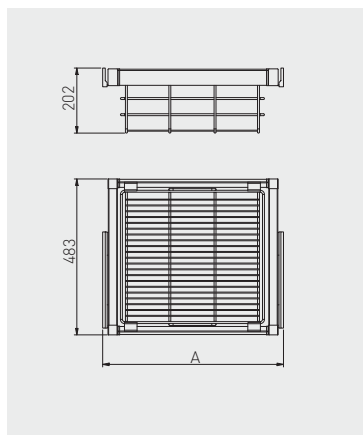

Kosz ażurowy ELITE
Openwork basket ELITE
Ажурная корзина ELITE



	A min./max.			
WG-KOSZ60-10	560 - 618	pełny full полное	biały white белый	stal, tworzywo steel, plastic сталь, пластмасса
WG-KOSZ70-10	660 - 718			
WG-KOSZ80-10	760 - 818			
WG-KOSZ90-10	860 - 918			
WG-KOSZ60-60	560 - 618		antracyt anthracite антрацит	
WG-KOSZ70-60	660 - 718			
WG-KOSZ80-60	760 - 818			
WG-KOSZ90-60	860 - 918			

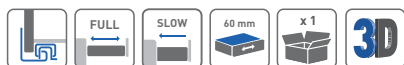

Kosz rattanowy ELITE
Rattan basket ELITE
Плетеная из rattana корзина ELITE

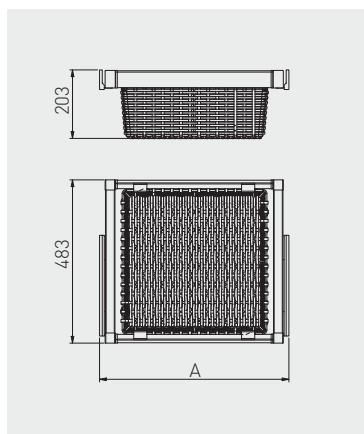



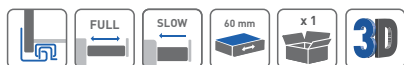

	A min./max.			
WG-KOSZR60-10	560 – 618	pełny full полное	biały white белый	stal, tworzywo steel, plastic сталь, пластмасса
WG-KOSZR70-10	660 – 718			
WG-KOSZR80-10	760 – 818			
WG-KOSZR90-10	860 – 918			
WG-KOSZR60-60	560 – 618		antracyt anthracite антрацит	
WG-KOSZR70-60	660 – 718			
WG-KOSZR80-60	760 – 818			
WG-KOSZR90-60	860 – 918			

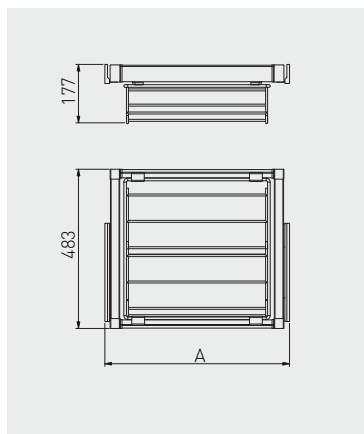

Szuflada ELITE na obuwie
Pull out shoes rack ELITE
Полка для обуви ELITE





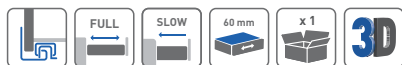

	A min./max.			
WG-POBUW60-10	560 - 618	pełny full полное	biały white белый	stal, tworzywo steel, plastic сталь, пластмасса
WG-POBUW70-10	660 - 718			
WG-POBUW80-10	760 - 818			
WG-POBUW90-10	860 - 918			
WG-POBUW60-60	560 - 618		antracyt anthracite антрацит	
WG-POBUW70-60	660 - 718			
WG-POBUW80-60	760 - 818			
WG-POBUW90-60	860 - 918			

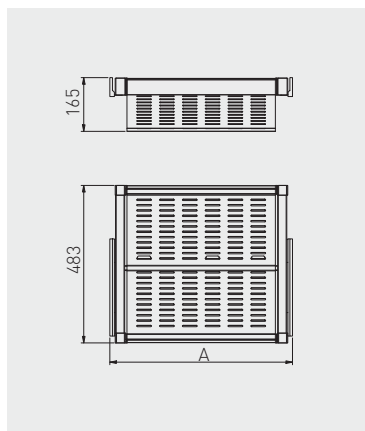

Szuflada ELITE na obuwie metalowa
 Metal pull out shoes rack ELITE
 Металлическая полка для обуви ELITE



	A min./max.			
WG-POBUWM60-10	560 - 618	pełny full полное	biały white белый	stal, tworzywo steel, plastic сталь, пластмасса
WG-POBUWM70-10	660 - 718			
WG-POBUWM80-10	760 - 818			
WG-POBUWM90-10	860 - 918			
WG-POBUWM60-60	560 - 618			
WG-POBUWM70-60	660 - 718			
WG-POBUWM80-60	760 - 818			
WG-POBUWM90-60	860 - 918			

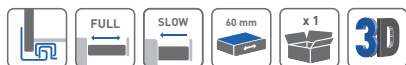

Organizer ELITE
Organiser ELITE
Органайзер ELITE

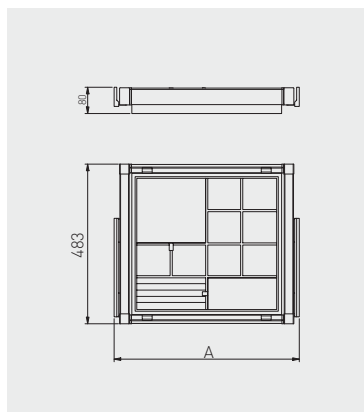



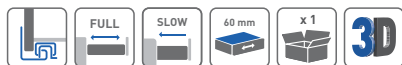

	A min./max.			
WG-PRZEG60-10	560 - 618	pełny full полное	biały white белый	stal, tworzywo steel, plastic сталь, пластмасса
WG-PRZEG70-10	660 - 718			
WG-PRZEG80-10	760 - 818			
WG-PRZEG90-10	860 - 918			
WG-PRZEG60-60	560 - 618		antracyt anthracite антрацит	
WG-PRZEG70-60	660 - 718			
WG-PRZEG80-60	760 - 818			
WG-PRZEG90-60	860 - 918			

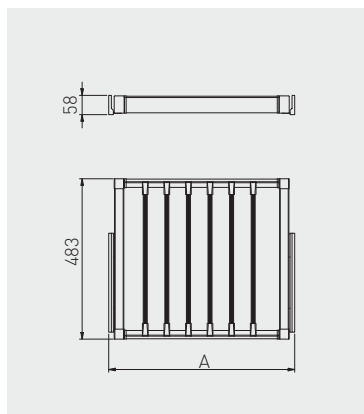

Wieszak ELITE na spodnie
 Wardrobe trouser rack ELITE
 Вешалка для брюк ELITE



	A min./max.			
WG-WSPOD60-10	560 – 618	petny full полное	biały white белый	stal, tworzywo steel, plastic сталь, пластмасса
WG-WSPOD70-10	660 – 718			
WG-WSPOD80-10	760 – 818			
WG-WSPOD90-10	860 – 918			
WG-WSPOD60-60	560 – 618		antracyt anthracite антрацит	
WG-WSPOD70-60	660 – 718			
WG-WSPOD80-60	760 – 818			
WG-WSPOD90-60	860 – 918			

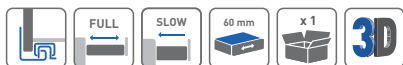

Drażek prostokątny z rozetkami
Rectangular wardrobe rail with socket
Прямоугольный мебельный вкладыш

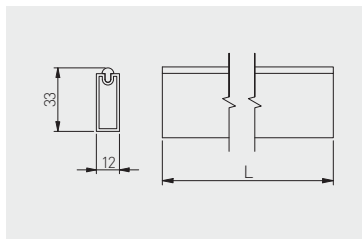





		 L mm		
WG-RRPSET-A-10		3000	biały white белый	aluminium, tworzywo aluminium, plastic алюминий, пластмасса
WG-RRPSET-B-10				
WG-RRPSET-A-60			antracyt anthracite антрацит	
WG-RRPSET-B-60				

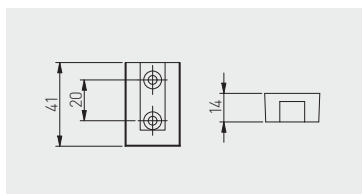

Rozetka prostokątna
Rectangular wardrobe rail socket
Прямоугольный монтажный крепеж







				
WG-RDRP-10		rozetka prostokątna z zaślepką rectangular wardrobe rail socket with end cap прямоугольный монтажный крепеж с заглушкой	biały white белый	ZnAl, tworzywo ZnAl, plastic ZnAl, пластмасса
WG-RDRP-60			antracyt anthracite антрацит	
WG-RDRO-10		rozetka prostokątna bez zaślepki rectangular wardrobe rail socket without end cap прямоугольный монтажный крепеж без заглушки	biały white белый	stal steel сталь
WG-RDRO-60			antracyt anthracite антрацит	

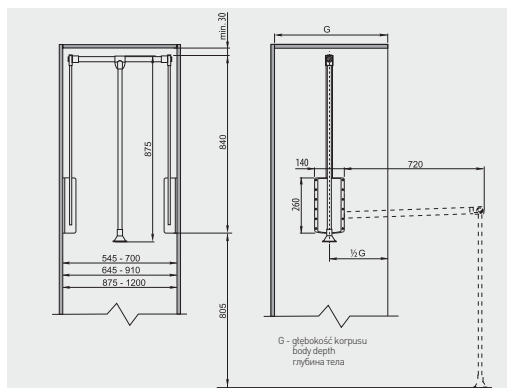

Pantograf z podnośnikiem olejowym
 Pull-down wardrobe rail – oil
 Пантограф с масляным подъемником



	 mm	 kg		
PG-ST83115-10A	875 – 1200	8	biały white белый	stal steel сталь
PG-ST6083-10A	645 – 910			
PG-ST4560-10A	545 – 700			
PG-ST83115-60	875 – 1200		antracyt anthracite антрацит	
PG-ST6083-60	645 – 910			
PG-ST4560-60	545 – 700			





Szuflada SMART na obuwie
 Pull out shoes rack SMART
 Полка SMART для обуви

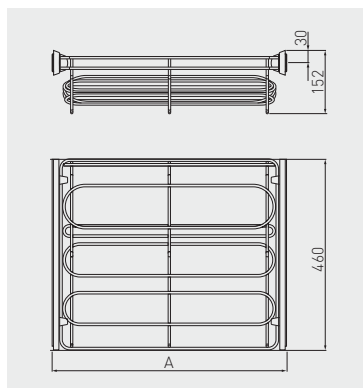

A
min./max.



W-WOBU60-BP-60	komplet bez prowadnic set without slides комплексция без направляющих	600	petny full полное	szary gray серый	stal, tworzywo steel, plastic сталь, пластмасса
W-WOBU60-VE-60	na prowadnicy kulkowej H45 z funkcją cichego zamknięcia on ball bearing slide H45 with soft closing на шариковой направляющей H45 с доводчиком				
W-WOBU70-BP-60	komplet bez prowadnic set without slides комплексция без направляющих	700	petny full полное	szary gray серый	stal, tworzywo steel, plastic сталь, пластмасса
W-WOBU70-VE-60	na prowadnicy kulkowej H45 z funkcją cichego zamknięcia on ball bearing slide H45 with soft closing на шариковой направляющей H45 с доводчиком				
W-WOBU80-BP-60	komplet bez prowadnic set without slides комплексция без направляющих	800	petny full полное	szary gray серый	stal, tworzywo steel, plastic сталь, пластмасса
W-WOBU80-VE-60	na prowadnicy kulkowej H45 z funkcją cichego zamknięcia on ball bearing slide H45 with soft closing на шариковой направляющей H45 с доводчиком				
W-WOBU90-BP-60	komplet bez prowadnic set without slides комплексция без направляющих	900	petny full полное	szary gray серый	stal, tworzywo steel, plastic сталь, пластмасса
W-WOBU90-VE-60	na prowadnicy kulkowej H45 z funkcją cichego zamknięcia on ball bearing slide H45 with soft closing на шариковой направляющей H45 с доводчиком				



W-WOBU60-BP-10	komplet bez prowadnic set without slides комплексция без направляющих	600		560 – 568		stal, tworzywo steel, plastic сталь, пластмасса
W-WOBU60-VE-10	na prowadnicy kulkowej H45 z funkcją cichego zamknięcia on ball bearing slide H45 with soft closing на шариковой направляющей H45 с доводчиком					
W-WOBU70-BP-10	komplet bez prowadnic set without slides комплексция без направляющих	700		660 – 668		
W-WOBU70-VE-10	na prowadnicy kulkowej H45 z funkcją cichego zamknięcia on ball bearing slide H45 with soft closing на шариковой направляющей H45 с доводчиком					
W-WOBU80-BP-10	komplet bez prowadnic set without slides комплексция без направляющих	800	pełny full полное	760 – 768	biały white белый	
W-WOBU80-VE-10	na prowadnicy kulkowej H45 z funkcją cichego zamknięcia on ball bearing slide H45 with soft closing на шариковой направляющей H45 с доводчиком					
W-WOBU90-BP-10	komplet bez prowadnic set without slides комплексция без направляющих	900		860 – 868		
W-WOBU90-VE-10	na prowadnicy kulkowej H45 z funkcją cichego zamknięcia on ball bearing slide H45 with soft closing на шариковой направляющей H45 с доводчиком					





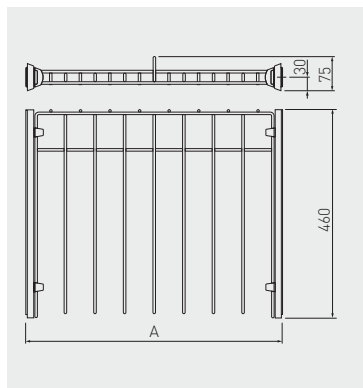

Wieszak SMART na spodnie
 SMART wardrobe trouser rack
 Вешалка SMART для брюк

 A
min./max.



W-WSPD60-BP-60	komplet bez prowadnic set without slides комплектция без направляющих	600	petny full полное	szary gray серый	stal, tworzywo steel, plastic сталь, пластмасса
W-WSPD60-VE-60	na prowadnicy kulkowej H45 z funkcją cichego zamknięcia on ball bearing slide H45 with soft closing на шариковой направляющей H45 с доводчиком				
W-WSPD70-BP-60	komplet bez prowadnic set without slides комплектция без направляющих	700	petny full полное	szary gray серый	stal, tworzywo steel, plastic сталь, пластмасса
W-WSPD70-VE-60	na prowadnicy kulkowej H45 z funkcją cichego zamknięcia on ball bearing slide H45 with soft closing на шариковой направляющей H45 с доводчиком				
W-WSPD80-BP-60	komplet bez prowadnic set without slides комплектция без направляющих	800	petny full полное	szary gray серый	stal, tworzywo steel, plastic сталь, пластмасса
W-WSPD80-VE-60	na prowadnicy kulkowej H45 z funkcją cichego zamknięcia on ball bearing slide H45 with soft closing на шариковой направляющей H45 с доводчиком				
W-WSPD90-BP-60	komplet bez prowadnic set without slides комплектция без направляющих	900	petny full полное	szary gray серый	stal, tworzywo steel, plastic сталь, пластмасса
W-WSPD90-VE-60	na prowadnicy kulkowej H45 z funkcją cichego zamknięcia on ball bearing slide H45 with soft closing на шариковой направляющей H45 с доводчиком				



		 mm	 A min./max.		
W-WSPD60-BP-10	komplet bez prowadnic set without slides комплексция без направляющих	600	560 – 568	biały white белый	stal, tworzywo steel, plastic сталь, пластмасса
W-WSPD60-VE-10	na prowadnicy kulkowej H45 z funkcją cichego zamknięcia on ball bearing slide H45 with soft closing на шариковой направляющей H45 с доводчиком				
W-WSPD70-BP-10	komplet bez prowadnic set without slides комплексция без направляющих	700	660 – 668		
W-WSPD70-VE-60	na prowadnicy kulkowej H45 z funkcją cichego zamknięcia on ball bearing slide H45 with soft closing на шариковой направляющей H45 с доводчиком				
W-WSPD80-BP-10	komplet bez prowadnic set without slides комплексция без направляющих	800	760 – 768		
W-WSPD80-VE-10	na prowadnicy kulkowej H45 z funkcją cichego zamknięcia on ball bearing slide H45 with soft closing на шариковой направляющей H45 с доводчиком				
W-WSPD90-BP-10	komplet bez prowadnic set without slides комплексция без направляющих	900	860 – 868		
W-WSPD90-VE-10	na prowadnicy kulkowej H45 z funkcją cichego zamknięcia on ball bearing slide H45 with soft closing на шариковой направляющей H45 с доводчиком				

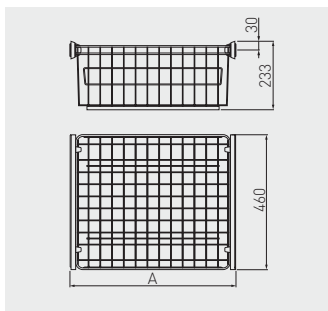

Kosz SMART na bieliznę SMART wardrobe basket Корзина для шкафа SMART

 A
min./max.

W-WK060-BP-60	komplet bez prowadnic set without slides комплексия без направляющих	600	560 – 568	pełny full полное	szary gray серый	stal, tworzywo steel, plastic сталь, пластмасса
W-WK060-VE-60	na prowadnicy kulkowej H45 z funkcją cichego zamknięcia on ball bearing slide H45 with soft closing на шариковой направляющей H45 с доводчиком					
W-WK070-BP-60	komplet bez prowadnic set without slides комплексия без направляющих	700	660 – 668			
W-WK070-VE-60	na prowadnicy kulkowej H45 z funkcją cichego zamknięcia on ball bearing slide H45 with soft closing на шариковой направляющей H45 с доводчиком					
W-WK080-BP-60	komplet bez prowadnic set without slides комплексия без направляющих	800	760 – 768			
W-WK080-VE-60	na prowadnicy kulkowej H45 z funkcją cichego zamknięcia on ball bearing slide H45 with soft closing на шариковой направляющей H45 с доводчиком					
W-WK090-BP-60	komplet bez prowadnic set without slides комплексия без направляющих	900	860 – 868			
W-WK090-VE-60	na prowadnicy kulkowej H45 z funkcją cichego zamknięcia on ball bearing slide H45 with soft closing на шариковой направляющей H45 с доводчиком					





 A
min./max.

W-WK060-BP-10	komplet bez prowadnic set without slides комплектция без направляющих	600		560 – 568		
W-WK060-VE-10	na prowadnicy kulkowej H45 z funkcją cichego zamknięcia on ball bearing slide H45 with soft closing на шариковой направляющей H45 с доводчиком					
W-WK070-BP-10	komplet bez prowadnic set without slides комплектция без направляющих	700		660 – 668		
W-WK070-VE-10	na prowadnicy kulkowej H45 z funkcją cichego zamknięcia on ball bearing slide H45 with soft closing на шариковой направляющей H45 с доводчиком					
W-WK080-BP-10	komplet bez prowadnic set without slides комплектция без направляющих	800	pełny full полное	760 – 768		
W-WK080-VE-10	na prowadnicy kulkowej H45 z funkcją cichego zamknięcia on ball bearing slide H45 with soft closing на шариковой направляющей H45 с доводчиком					
W-WK090-BP-10	komplet bez prowadnic set without slides комплектция без направляющих	900		860 – 868		
W-WK090-VE-10	na prowadnicy kulkowej H45 z funkcją cichego zamknięcia on ball bearing slide H45 with soft closing на шариковой направляющей H45 с доводчиком					

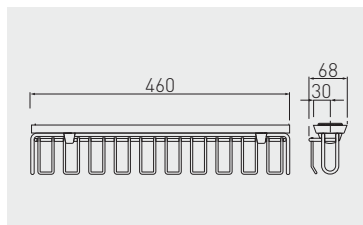

Wieszak SMART na paski i krawaty
 SMART belt and tie rack
 Вешалка для ремней и галстуков SMART









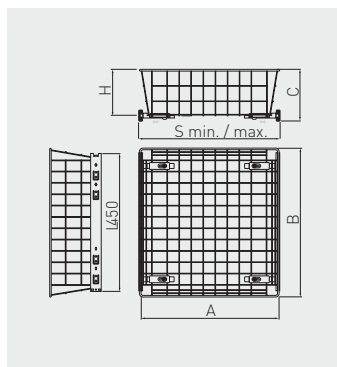

W-WKRP-BP-60	komplet bez prowadnic set without slides комплексция без направляющих	pełny full полное	szary gray серый	stal, tworzywo steel, plastic сталь, пластмасса
W-WKRP-VE-60	na prowadnicy kulkowej H45 z funkcją cichego zamknięcia on ball bearing slide H45 with soft closing на шариковой направляющей H45 с доводчиком			
W-WKRP-BP-10	komplet bez prowadnic set without slides комплексция без направляющих	biały white белый		
W-WKRP-VE-10	na prowadnicy kulkowej H45 z funkcją cichego zamknięcia on ball bearing slide H45 with soft closing на шариковой направляющей H45 с доводчиком			



Kosz na prowadnicy kulkowej H35*
 Wardrobe basket on a H35 ball bearing slide*
 Корзина на шариковых направляющих H35*









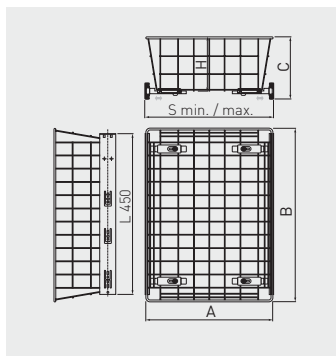





		 H mm	 A mm	 B mm	 C mm	 S min/max			
KO-SRPR100-30-10		300	100	255	485	123	260-285		
KO-SRPR100-40-10		400	100	355	485	123	360-385		
KO-SRPR100-50-10		500	100	455	485	123	460-485		
KO-SRPR100-60-10		600	100	555	485	123	560-585		
KO-SRPR150-30-10		300	150	255	485	173	260-285		
KO-SRPR150-40-10		400	150	355	485	173	360-385		
KO-SRPR150-50-10		500	150	455	485	173	460-485		
KO-SRPR150-60-10		600	150	555	485	173	560-585		
KO-SRPR200-30-10		300	200	255	485	223	260-285		
KO-SRPR200-40-10		400	200	355	485	223	360-385		
KO-SRPR200-50-10		500	200	455	485	223	460-485		
KO-SRPR200-60-10		600	200	555	485	223	560-585		
KO-SRPR150-30-OC		300	150	255	485	123	260-285	osynek galvanized гальваника	stal tworzywo steel plastic сталь пластмасса
KO-SRPR100-40-OC		400	100	355	485	123	360-385		
KO-SRPR100-30-OC		300	100	455	485	123	460-485	srebrny silver серебристый	
KO-SRPR100-50-OC		500	100	555	485	123	560-585		
KO-SRPR100-60-OC		600	100	255	485	173	260-285		
KO-SRPR150-40-OC		400	150	355	485	173	360-385		
KO-SRPR150-50-OC		500	150	455	485	173	460-485		
KO-SRPR150-60-OC		600	150	555	485	173	560-585		
KO-SRPR200-30-OC		300	200	255	485	223	260-285		
KO-SRPR200-40-OC		400	200	355	485	223	360-385		
KO-SRPR200-50-OC		500	200	455	485	223	460-485		
KO-SRPR200-60-OC		600	200	555	485	223	560-585		



Kosz na prowadnicy kulkowej H45 ze spawalniczem
 Wardrobe basket on a H45 adjustable ball bearing slide
 Корзина на шариковых направляющих H45









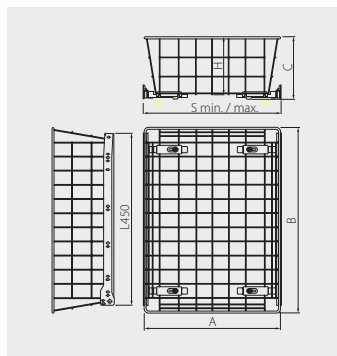

		 mm	 mm	 mm	 mm	 mm	 min./max.				
KO-SRH4550-40-OC	400	50	355	485	73	360 - 385					
KO-SRH4550-50-OC	500	50	455	485	73	460 - 485				biały white белый	
KO-SRH4550-60-OC	600	50	555	485	73	560 - 585				осынок galvanized гальваника	stal steel сталь
KO-SRH45200-40-OC	400	200	355	485	223	360 - 385				srebrny silver серебристый	
KO-SRH45200-50-OC	500	200	455	485	223	460 - 485					
KO-SRH45200-60-OC	600	200	555	485	223	560 - 585					



Kosz na prowadnicy rolkowej L = 450*
 Wardrobe basket on a L = 450 slide*
 Корзина на роликовых направляющих L = 450*



		 H mm	 A mm	 B mm	 C mm	 S min./max.				
KO-SRPR100-30-10		300	100	255	485	115	260 – 285	osynek galvanized гальваника	biały white белый	stal, tworzywo steel, plastic сталь, пластмасса
KO-SRPR100-40-10		400	100	355	485	115	360 – 385			
KO-SRPR100-50-10		500	100	455	485	115	460 – 485			
KO-SRPR100-60-10		600	100	555	485	115	560 – 585			
KO-SRPR150-30-10		300	150	255	485	165	260 – 285			
KO-SRPR150-40-10		400	150	355	485	165	360 – 385			
KO-SRPR150-50-10		500	150	455	485	165	460 – 485			
KO-SRPR150-60-10		600	150	555	485	165	560 – 585			
KO-SRPR200-30-10		300	200	255	485	215	260 – 285			
KO-SRPR200-40-10		400	200	355	485	215	360 – 385			
KO-SRPR200-50-10		500	200	455	485	215	460 – 485			
KO-SRPR200-60-10		600	200	555	485	215	560 – 585			
KO-SRPR150-30-OC		300	150	255	485	115	260 – 285			
KO-SRPR100-40-OC		400	100	355	485	115	360 – 385			
KO-SRPR100-30-OC		300	100	255	485	115	460 – 485			
KO-SRPR100-50-OC		500	100	455	485	115	560 – 585			
KO-SRPR100-60-OC		600	100	555	485	165	260 – 285			
KO-SRPR150-40-OC		400	150	355	485	165	360 – 385			
KO-SRPR150-50-OC		500	150	455	485	165	460 – 485			
KO-SRPR150-60-OC		600	150	555	485	165	560 – 585			
KO-SRPR200-30-OC		300	200	255	485	215	260 – 285			
KO-SRPR200-40-OC		400	200	355	485	215	360 – 385			
KO-SRPR200-50-OC		500	200	455	485	215	460 – 485			
KO-SRPR200-60-OC		600	200	555	485	215	560 – 585			
KO-SRPR100-30-OC		300	100	255	485	115	460 – 485			
KO-SRPR100-50-OC		500	100	455	485	115	560 – 585			
KO-SRPR100-60-OC		600	100	555	485	165	260 – 285			
KO-SRPR150-40-OC		400	150	355	485	165	360 – 385			
KO-SRPR150-50-OC		500	150	455	485	165	460 – 485			
KO-SRPR150-60-OC		600	150	555	485	165	560 – 585			
KO-SRPR200-30-OC		300	200	255	485	215	260 – 285			
KO-SRPR200-40-OC		400	200	355	485	215	360 – 385			
KO-SRPR200-50-OC		500	200	455	485	215	460 – 485			
KO-SRPR200-60-OC		600	200	555	485	215	560 – 585			
KO-SRPR100-30-OC		300	100	255	485	115	460 – 485			
KO-SRPR100-50-OC		500	100	455	485	115	560 – 585			
KO-SRPR100-60-OC		600	100	555	485	165	260 – 285			
KO-SRPR150-40-OC		400	150	355	485	165	360 – 385			
KO-SRPR150-50-OC		500	150	455	485	165	460 – 485			
KO-SRPR150-60-OC		600	150	555	485	165	560 – 585			
KO-SRPR200-30-OC		300	200	255	485	215	260 – 285			
KO-SRPR200-40-OC		400	200	355	485	215	360 – 385			
KO-SRPR200-50-OC		500	200	455	485	215	460 – 485			
KO-SRPR200-60-OC		600	200	555	485	215	560 – 585			
KO-SRPR100-30-OC		300	100	255	485	115	460 – 485			
KO-SRPR100-50-OC		500	100	455	485	115	560 – 585			
KO-SRPR100-60-OC		600	100	555	485	165	260 – 285			
KO-SRPR150-40-OC		400	150	355	485	165	360 – 385			
KO-SRPR150-50-OC		500	150	455	485	165	460 – 485			
KO-SRPR150-60-OC		600	150	555	485	165	560 – 585			
KO-SRPR200-30-OC		300	200	255	485	215	260 – 285			
KO-SRPR200-40-OC		400	200	355	485	215	360 – 385			
KO-SRPR200-50-OC		500	200	455	485	215	460 – 485			
KO-SRPR200-60-OC		600	200	555	485	215	560 – 585			



Wieszak na spodnie podwieszany
 Wardrobe pull-out trouser rack
 Вешалка для брюк подвесная

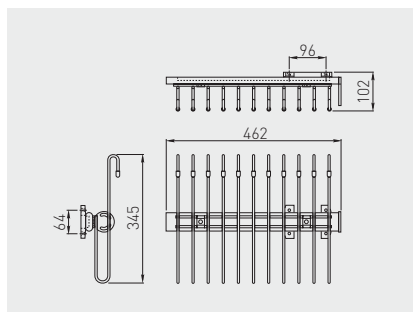

WW-WSP00-01	niepełny partial неполное	chrom, aluminium, czarny chrome, aluminium, black хром, алюминий, чёрный	stal, aluminium, tworzywo steel, aluminium, plastic сталь, алюминий, пластмасса

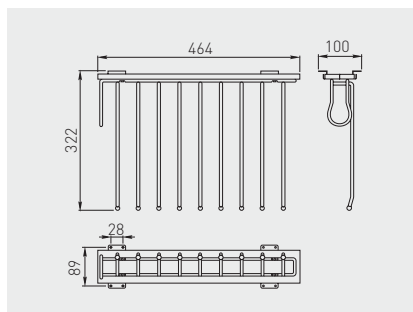

Wieszak WS na spodnie
 Trouser rack WS
 Вешалка WS для брюк

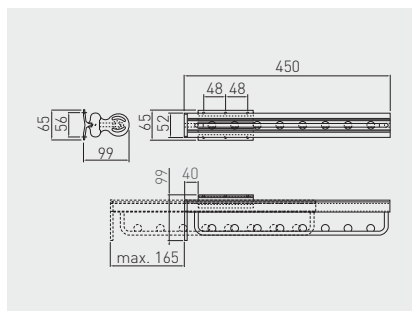

WW-WSP000-01	prawy right правый	niepełny partial неполное	chrom, aluminium, czarny chrome, aluminium, black хром, алюминий, чёрный	stal, aluminium, tworzywo steel, aluminium, plastic сталь, алюминий, пластмасса
WW-WSL000-01	lewy left левый			

Wieszak WU na ubrania
Clothes hanger WU
Вешалка WU для одежды







			
WW-WUBR00-01	niepełny partial неполное	chrom, aluminium, czarny chrome, aluminium, black хром, алюминий, чёрный	stal, aluminium, tworzywo steel, aluminium, plastic сталь, алюминий, пластмасса

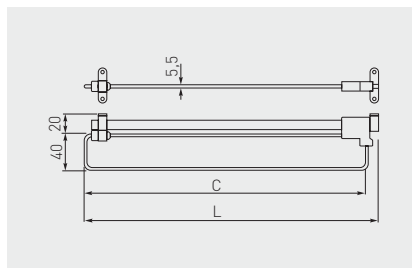







Wieszak WSL
Hanger WSL
Вешалка WSL

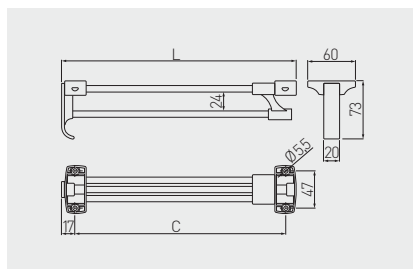

	 C mm	 L mm		
WW-WSL250-01	235	250	chrom chrome хром	stal steel сталь
WW-WSL300-01	285	300		
WW-WSL350-01	335	350		
WW-WSL400-01	385	400		
WW-WSL450-01	435	450		
WW-WSL500-01	485	500		





Wieszak WSD wysuwny
Retractable hanger WSD
Выдвижная подвеска WSD

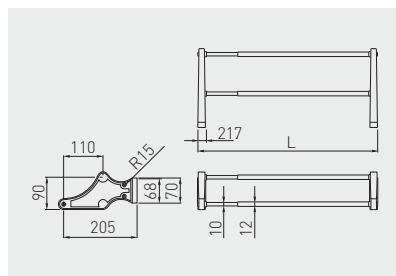

	 C mm	 L mm		
WW-WSD250-01B	220	252	chrom, czarny chrome, black хром, чёрный	stal, tworzywo steel, plastic сталь, пластмасса
WW-WSD300-01B	270	302		
WW-WSD350-01B	320	352		
WW-WSD400-01B	370	402		
WW-WSD450-01B	420	452		
WW-WSD500-01B	470	502		

Półka na obuwie
Shoe rack
Полка для обуви



	 L mm		
PP-P04570-20	415 - 700	chrom, aluminium, czarny chrome, aluminium, black хром, алюминий, чёрный	stal, aluminium, tworzywo steel, aluminium, plastic сталь, алюминий, пластмасса
PP-P80110-20	715 - 1100	chrom, czarny chrome, black хром, чёрный	stal, tworzywo steel, plastic сталь, пластмасса



Zawias do półki na obuwie
Hinge for shoe rack
Крепление для полки под обувь

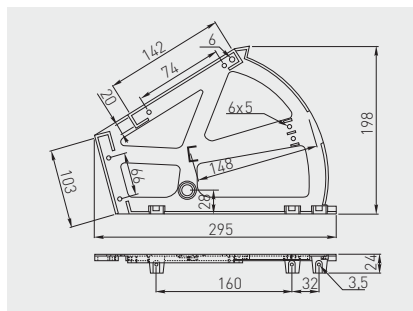

Zastosowanie dla płyty 12 mm
For 12 mm board
Крепление к плите 12 мм



WW-ZWBUT2-10	biały / white / белый	tworzywo plastic пластмасса
WW-ZWBUT2-20	czarny / black / чёрный	



Pantograf z podnośnikiem gazowym
Pull-down wardrobe rail – gas
Пантограф с газовым подъемником

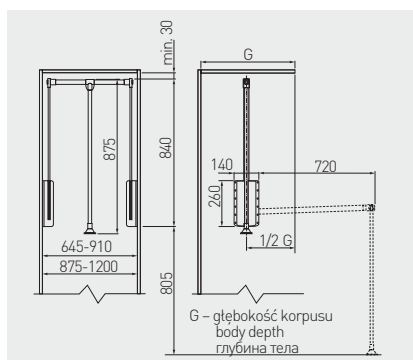





PG-GA4560-10	545 – 700	12	biały / white / белый	stal, tworzywo steel, plastic сталь, пластмасса
PG-GA6083-10	645 – 910			
PG-GA83115-10	875 – 1200		czarny / black / чёрный	
PG-GA4560-20	545 – 700			
PG-GA6083-20	645 – 910			
PG-GA8311520	875 – 1200			

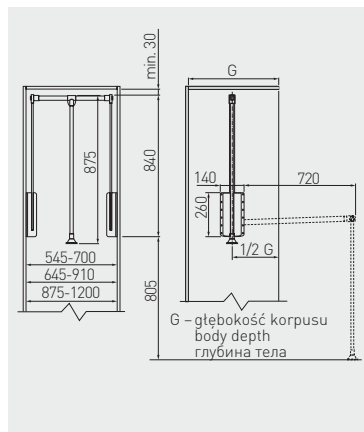

Pantograf z podnośnikiem olejowym
 Pull-down wardrobe rail – oil
 Пантограф с масляным подъемником



	 mm	 kg		
PG-AL4560-20	545 – 700	8	aluminium / aluminium / алюминий	aluminium, tworzywo aluminium, plastic алюминий, пластмасса
PG-AL6083-20	645 – 910			
PG-AL8311520	875 – 1200			
PG-ST4560-10	545 – 700	8	biały / white / белый czarny / black / чёрный	stal, tworzywo steel, plastic сталь, пластмасса
PG-ST4560-20	645 – 910			
PG-ST6083-10				
PG-ST6083-20	875 – 1200			
PG-ST83115-10		875 – 1200	biały / white / белый czarny / black / чёрный	
PG-ST8311520				





Segregator PRACTI ECO 400
 Trash bin PRACTI ECO 400
 Сегрегатор PRACTI ECO 400

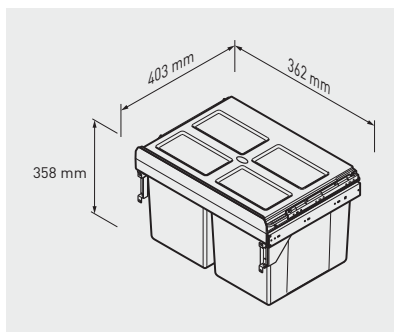

PB-45-400MF-2X16-60A

400

2 x 16 L

antracyt
 anthracite
 антрацит

tworzywo / plastic / пластмасса



Segregator PRACTI ECO 300
 Trash bin PRACTI ECO 300
 Серператор PRACTI ECO 300







PB-45-0010X3-60A

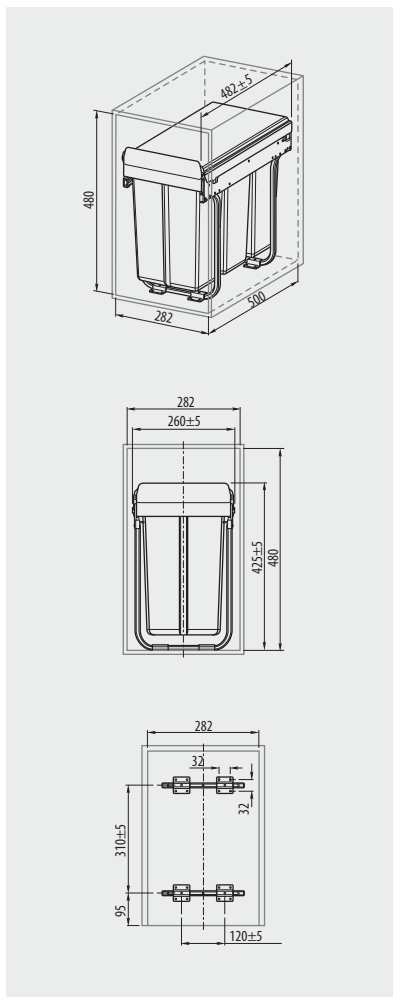

PB-45-002010-60A



Na prowadnicy kulkowej H45 z cichym domykiem
 On ball bearing slide H45 with soft closing
 На шариковой направляющей H45 с доводчиком

	 mm			
PB-45-0010X3-60A	300	3 x 10 L	antracyt anthracite антрацит	tworzywo / plastic / пластмасса
PB-45-002010-60A	300	10 L, 20 L		



Segregator PRACTI ECO 400
 Trash bin PRACTI ECO 400
 Серператор PRACTI ECO 400







PB-45-002X20-60A

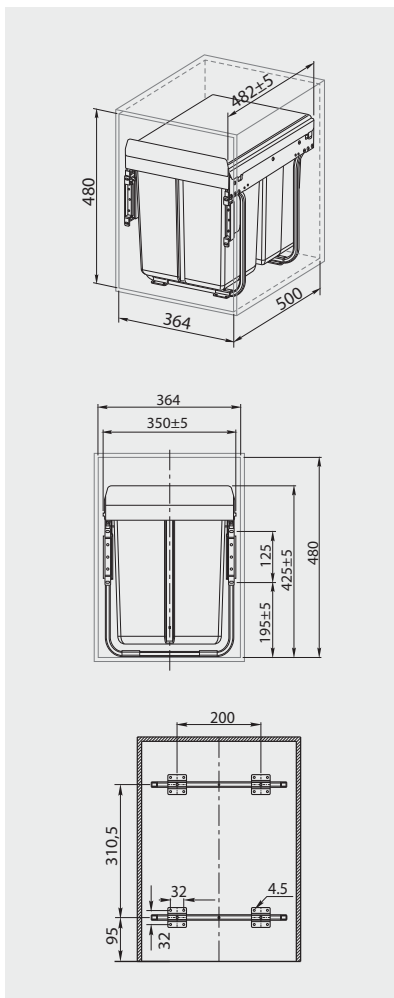

PB-45-202X10-60A

Na prowadnicy kulkowej H45 z cichym domykiem
 On ball bearing slide H45 with soft closing
 На шариковой направляющей H45 с доводчиком



				
PB-45-002X20-60A	400	2 x 20 L	antracyt anthracite антрацит	tworzywo / plastic / пластмасса
PB-45-202X10-60A	400	20 L, 2 x 10 L		



Segregator PRACTI ECO 400 z mocowaniem przednim
 Trash bin PRACTI ECO 400 with door mount bracket
 Сегрегатор PRACTI ECO 400 с передним креплением



PB-45-MF002X20-60A



PB-45-MF202X10-60A

Na prowadnicy kulkowej H45 z cichym domykiem
 On ball bearing slide H45 with soft closing
 На шариковой направляющей H45 с доводчиком

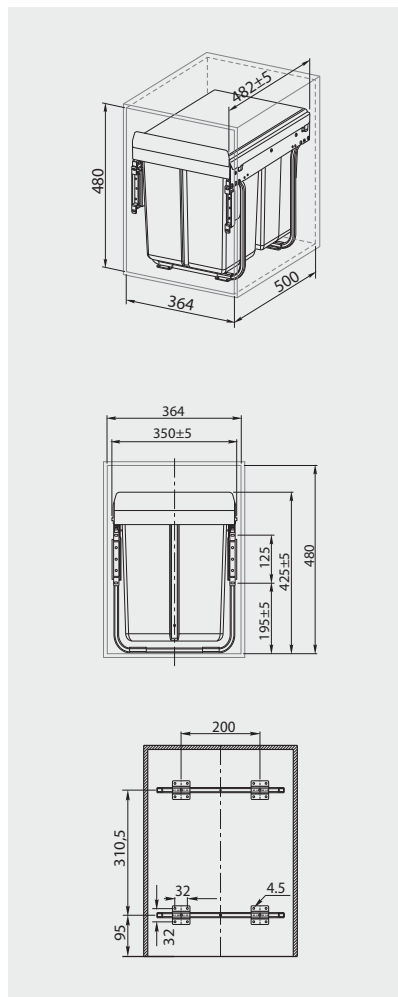

PB-45-MF002X20-60A	400	2 x 20 L	antracyt anthracite антрацит	tworzywo / plastic / пластмасса
PB-45-MF202X10-60A		20 L, 2 x 10 L		



Segregator PRACTI ECO 450, niski
 Trash bin PRACTI ECO 450, low
 Сегрегатор PRACTI ECO 450, низкий



PB-45-002X15-60A

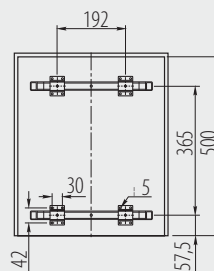
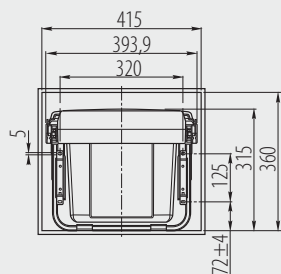
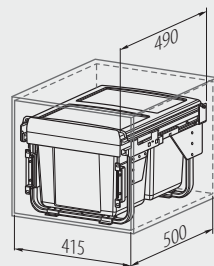

Na prowadnicy z cichym domykiem
 On slide with soft closing
 На направляющей с доводчиком

	 mm			
PB-45-002X15-60A	450	2 x 15 L	antracyt anthracite антрацит	tworzywo / plastic / пластмасса



Segregator PRACTI ECO 450 niski z mocowaniem przednim
 Trash bin PRACTI ECO 450 low with door mount bracket
 Сегрегатор PRACTI ECO 450 низкий с передним креплением



PB-45-MF2X15-60A

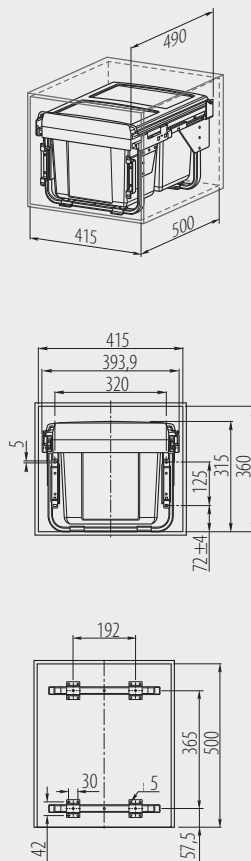

Na prowadnicy z cichym domykiem
 On slide with soft closing
 На направляющей с доводчиком

				
PB-45-MF2X15-60A	450	2 x 15 L	antracyt anthracite антрацит	tworzywo / plastic / пластмасса



Segregator PRACTI ECO 450 wysoki
 Trash bin PRACTI ECO 450 high
 Сегрегатор PRACTI ECO 450 высокий



PB-45-450-2X20-60A



PB-45-0202X10-60A

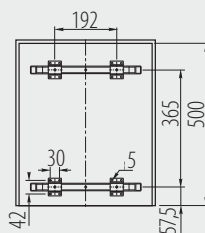
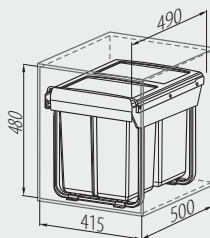
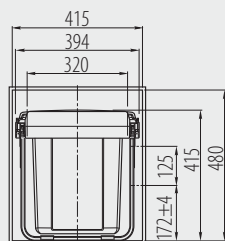

Na prowadnicy z cichym domykiem
 On slide with soft closing
 На направляющей с доводчиком

				
PB-45-450-2X20-60A	450	2 x 20 L	antracyt anthracite антрацит	tworzywo / plastic / пластмасса
PB-45-0202X10-60A		20 L, 2 x 10 L		



Segregator PRACTI ECO 450 wysoki z mocowaniem przednim
 Trash bin PRACTI ECO 450 high with door mount bracket
 Сегрегатор PRACTI ECO 450 высокий с передним креплением





PB-45-450MF202X10-60A

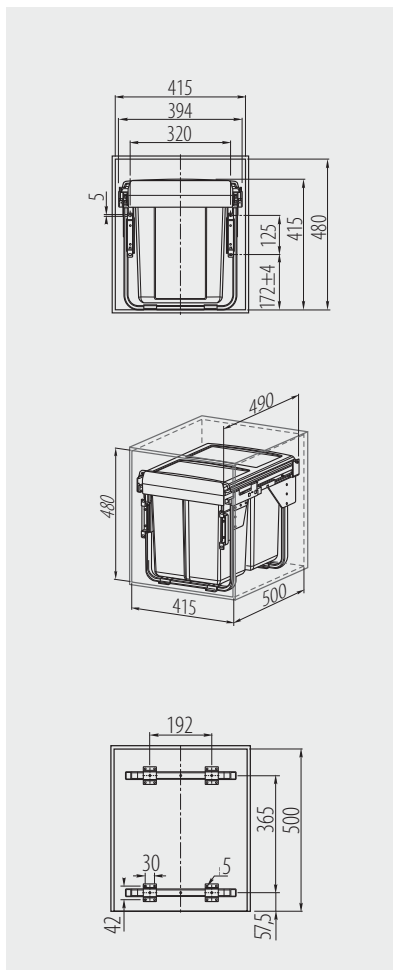

PB-45-MF2X20-60A



Na prowadnicy z cichym domykiem
 On slide with soft closing
 На направляющей с доводчиком

				
PB-45-450MF202X10-60A	450	20 L, 2 x 10 L	antracyt anthracite антрацит	tworzywo / plastic / пластмасса
PB-45-MF2X20-60A		2 x 20 L		



Segregator PRACTI ECO 600 wysoki z mocowaniem przednim
 Trash bin PRACTI ECO 600 high with door mount bracket
 Сегрегатор PRACTI ECO 600 высокий с передним креплением









PB-45-MF342X17-60A

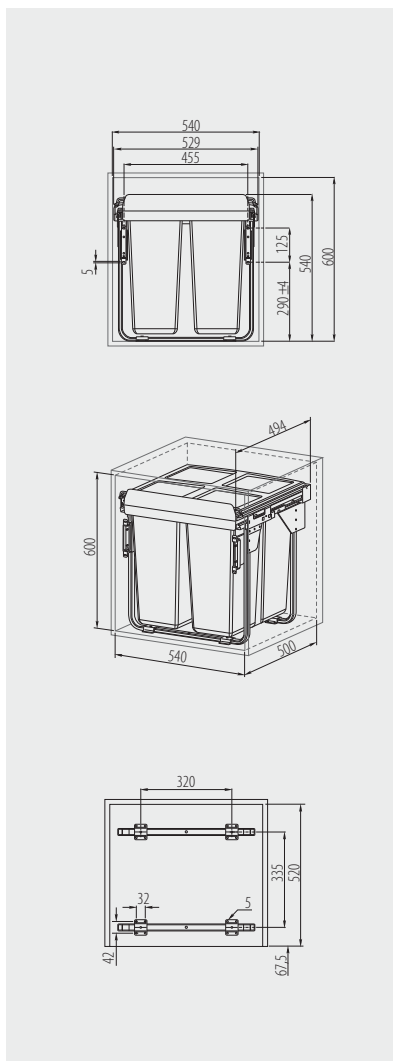

PB-45-MF2X34-60A

Na prowadnicy z cichym domykiem
 On slide with soft closing
 На направляющей с доводчиком



				
PB-45-MF342X17-60A	600	34 L, 2 x 17 L	antracyt anthracite антрацит	tworzywo / plastic / пластмасса
PB-45-MF2X34-60A		2 x 34 L		



Segregator PRACTI ECO 600
 Trash bin PRACTI ECO 600
 Сегрегатор PRACTI ECO 600

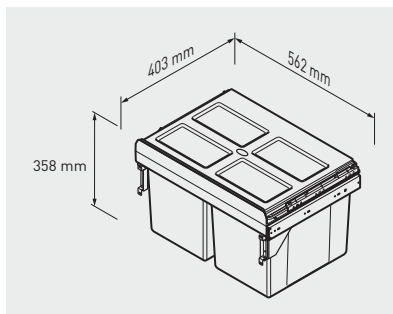

	 mm			
PB-45-600MF-2X27-60A	600	2 x 27 L	antracyt anthracite антрацит	tworzywo / plastic / пластмасса



Kosz CIRCA
 Trash bin CIRCA
 Мусорная корзина CIRCA

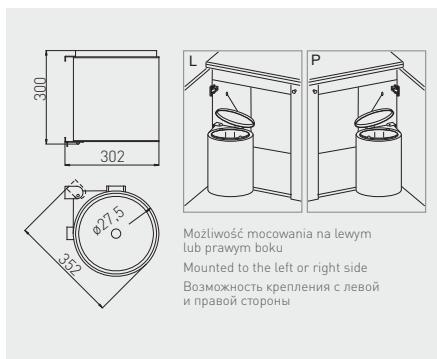

			
PB-91024160V	11 L	szary / gray / серый	tworzywo / plastic / пластмасса



Segregator MULTINO Trash bin MULTINO Сергегатор MULTINO

Przeznaczone do szuflad Modern Box
For Modern Box drawers
Только для ящиков Modern Box



PB-91114100B5-A



PB-91104100B5-A



PB-91634100B5V-A

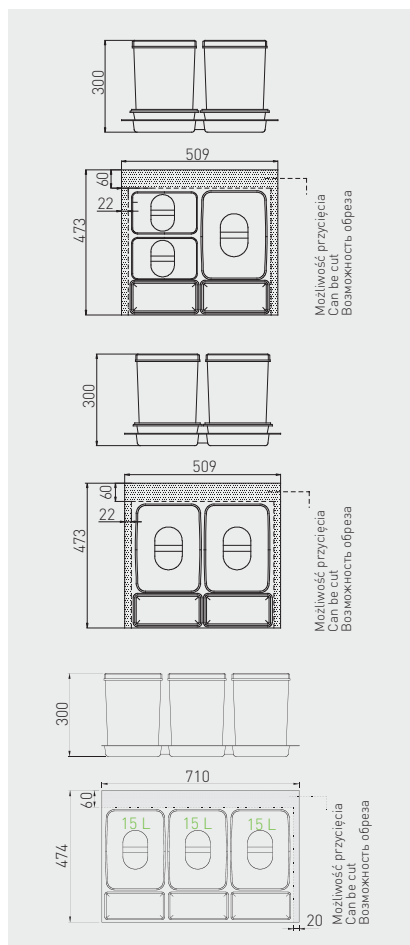

mm



PB-91104100B5-A	600	2 x 15 L, 2 brytfanki / 2 tray storage spaces / наполнители	antracyt anthracite антрацит	tworzywo plastic пластмасса
PB-91114100B5-A		1 x 15 L, 2 x 7 L, 2 brytfanki / 2 tray storage spaces / наполнители		
PB-91644100B5V-A	800	3 x 15 L, 3 brytfanki / 3 tray storage spaces / наполнители		
PB-91634100B5V-A		2 x 15 L, 2 x 7 L, 3 brytfanki / 3 tray storage spaces / наполнители		
PB-91164100B5-A	900	3 x 15 L, 3 brytfanki / 3 tray storage spaces / наполнители		



Segregator MULTINO Trash bin MULTINO Серегатор MULTINO

Przeznaczone do szuflad Modern Box
For Modern Box drawers
Только для ящиков Modern Box



PB-91644100B5



PB-91174100B5-A



PB-91164100B5-A

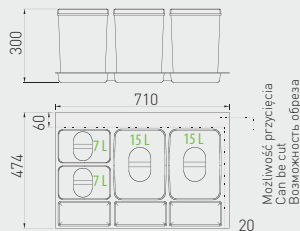

Segregator MULTINO 800 (bez przycinania) jest dopasowany do szuflady MODERN BOX NL = 500 zamontowanej w korpusie LW = 764*

Without modifications, the MULTINO 800 trash bin is designed to fit MODERN BOX NL = 500 drawer, mounted in a cabinet LW = 764*



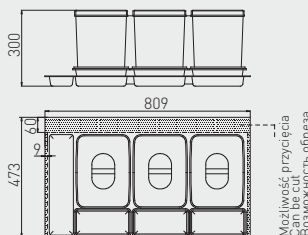
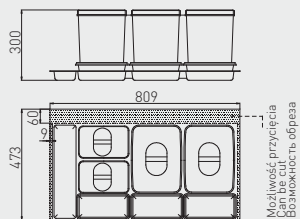

Серегатор MULTINO 800 (без обреза) подходит к системе ящиков MODERN BOX NL = 500, замонтированной в корпусе LW = 764*

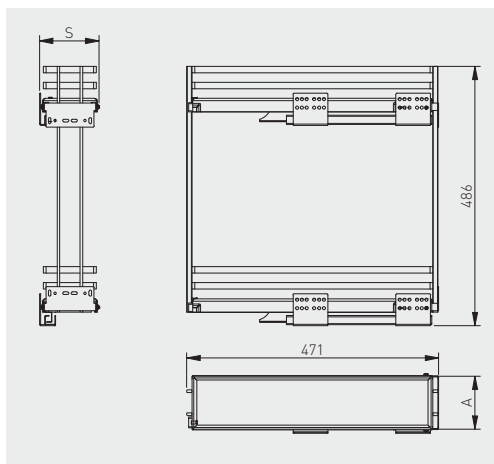

Cargo boczne Movix Pro z cichym domykiem
 Side cargo Movix Pro with soft closing
 Боковое карго MOVIX PRO с бесшумным закрытием

NEW









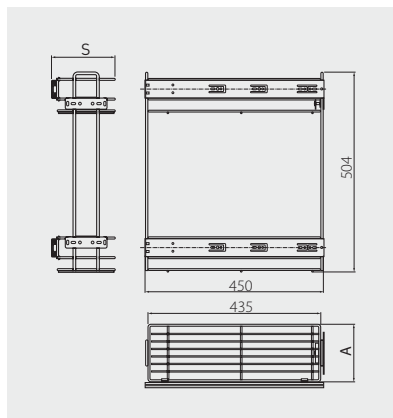

	 mm			
KO-200BO-60	200	ocynk galvanized гальваника	antracyt anthracite антрацит	stal steel сталь
KO-150BO-60	150			
KO-200BO-01	200		chrom chrome хром	
KO-150BO-01	150			



Cargo boczne na prowadnicy kulkowej H45 ze spowalniczem
 Side cargo on a H45 ball bearing slide with soft closing
 Выдвижная корзина с боковым креплением на шариковых направляющих H45 с механизмом плавного закрыwania









			 mm	 mm	 mm			
KO-1502BO-CR			150	95	110	ocynk galvanized гальваника	chrom chrome хром	stal steel сталь
KO-2002BO-CR			200	145	160		biały white белый	
KO-1502BO-10*			150	95	110			
KO-2002BO-10*	lewy / prawy left / right левый / правый		200	145	160			
KO-3002BO-10*			300	245	260			
KO-1502BO-SR			150	95	110		srebrny silver серебристый	
KO-2002BO-SR			200	145	160			
KO-3002BO-SR			300	245	260			

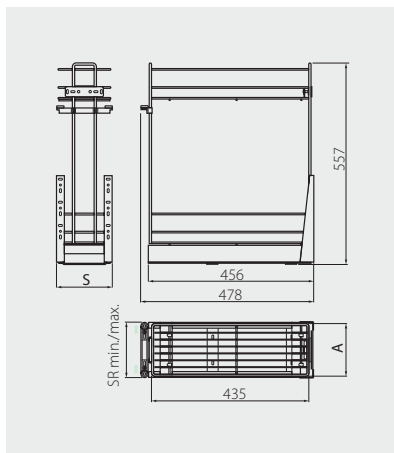

* Produkt dostępny na indywidualne zamówienie / Available for special orders / Товар доступен под заказ

Cargo dolne na prowadnicy kulkowej H45 ze spowalniczem
 Cargo lower ball bearing slide H45 with soft close system
 Выдвижная корзина для нижних шкафов на шариковых направляющих H45 с механизмом плавного закрытия



	 mm	 mm	 mm			
KO-1502MD-CR*	150	95	104	осынок galvanized гальваника	chrom chrome хром	stal steel сталь
KO-2002MD-CR	200	145	154			
KO-3002MD-CR	300	245	254			
KO-4002MD-CR*	400	345	345			
KO-5002MD-CR*	500	445	445			
KO-6002MD-CR*	600	545	554			
KO-1502MD-SR	150	95	104		srebrny silver серебристый	
KO-2002MD-SR	200	145	154			
KO-3002MD-SR	300	245	254			
KO-4002MD-SR	400	345	345			
KO-5002MD-SR*	500	445	445			
KO-6002MD-SR*	600	545	554			









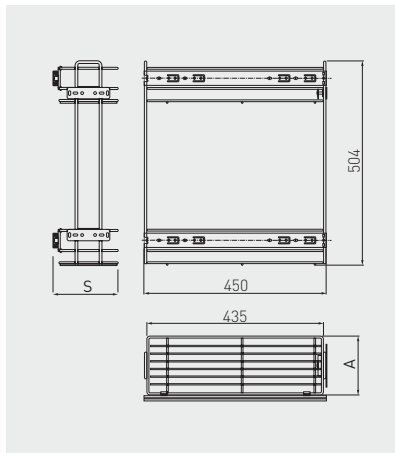

* Produkt dostępny na indywidualne zamówienie / Available for special orders / Товар доступен под заказ

Cargo boczne na prowadnicy kulkowej H35

Side cargo on a H35 ball bearing slide

Выдвижная корзина с боковым креплением на шариковых направляющих H35



		 mm	 mm	 mm			
KO-CMB200-PW-01*	lewy / prawy left / right левый / правый	200	145	160	ocynk galvanized гальваника	chrom chrome хром	stal steel сталь
KO-CMB300-PW-01*		300	245	260		biaty white белый	
KO-CMB200-PW-10*		200	145	160		srebrny silver серебристый	
KO-CMB300-PW-10*		300	245	260			
KO-CMB150-PW-0C		150	95	110			
KO-CMB200-PW-0C		200	145	160			
KO-CMB300-PW-0C*		300	245	260			



* Produkt dostępny na indywidualne zamówienie / Available for special orders / Товар доступен под заказ

Ociekarka dwupoziomowa do montażu
Two tier dish drying rack
Двухуровневая сушилка для посуды (монтаж)



OC-A0150-06		
OC-A0160-06	stal szcztokowana brushed steel шлифованная сталь	stal nierdzewna stainless steel нержавеющая сталь
OC-A0170-06		
OC-A0180-06		
OC-A0190-06		

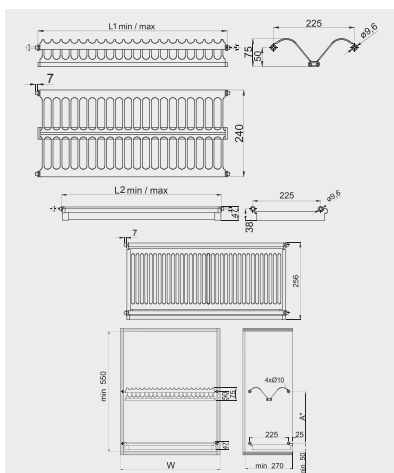

A* wymiar zależy od wysokości szafki i planowanego zagospodarowania (np. A = 275mm)
A* dimension depends on the height of the cabinet and space planning (e.g. A = 275mm)
A* размер зависит от высоты шкафчика и планировки внутреннего пространства (напр. A = 275мм)

L min./max.	W min./max.
430/480	450/475
530/580	550/575
630/680	650/675
730/780	750/775
830/880	850/875

Ociekarka jednopoziomowa do montażu
Dish drying rack
Сушилка для посуды (монтаж)



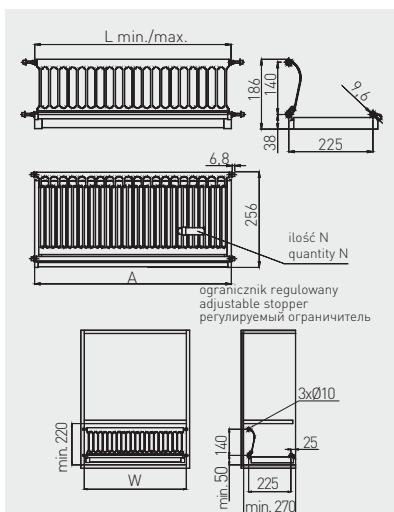

OC-A0660-06	stal szcztokowana brushed steel шлифованная сталь	stal nierdzewna stainless steel нержавеющая сталь
OC-A0680-06		

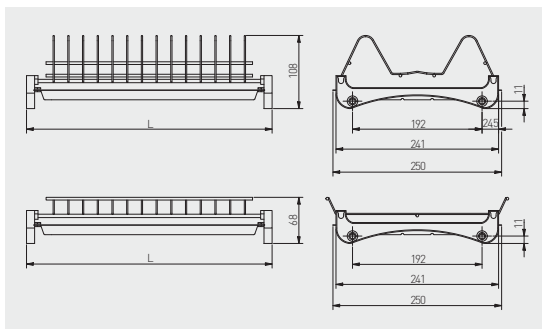

L min./max.	L min./max.	N
530/580	550/575	6
730/780	750/775	8

Ociekarka dwupoziomowa do montażu
 Two tier dish drying rack
 Двухуровневая сушилка для посуды (встраиваемая)



		 L mm		
OC-2PV340-02-18	do płyty 18 mm for 18 mm board для поверхности 18 мм	400	chrom chrome хром	
OC-2PV345-02-18		450		
OC-2PV350-02-18		500		
OC-2PV360-02-18		600		
OC-2PV360-02-18A*		600		
OC-2PV370-02-18		700		
OC-2PV380-02-18		800		
OC-2PV380-02-18A*		800		
OC-2PV390-02-18		900		



Ociekarka dwupoziomowa A04, wolnostojąca
Two tier dish drying rack A04
Сушилка для посуды настольная A04, двухуровневая

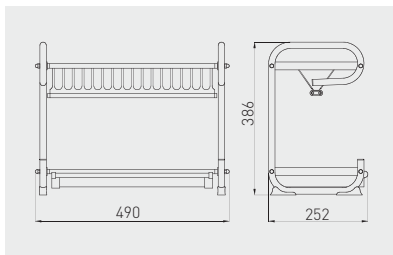

OC-A0450-06



stal szczotkowana
brushed steel
шлифованная сталь



stal nierdzewna
stainless steel
нержавеющая сталь



Ociekarka dwupoziomowa A03, wolnostojąca
Two tier dish drying rack A03
Сушилка для посуды настольная A03, двухуровневая

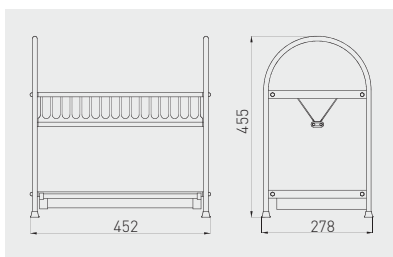

OC-A0350K-06



stal szczotkowana
brushed steel
шлифованная сталь



stal nierdzewna
stainless steel
нержавеющая сталь



Ociekarka dwupoziomowa z organizerem, wolnostojąca
 Two tier dish drying rack with organizer
 Сушилка для посуды и столовых приборов настольная, двухуровневая

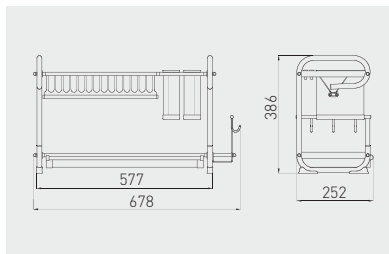

OC-A0460D-06



stal szczotkowana
 brushed steel
 шлифованная сталь



stal nierdzewna
 stainless steel
 нержавеющая сталь



Ociekarka zwijana
 Roll-up drying rack
 Складная сушилка

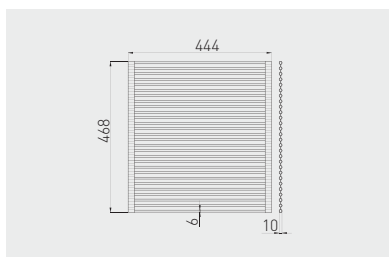

OC-E0707D-CZ



stal szczotkowana, czarny
 brushed steel, black
 шлифованная сталь, чёрный



stal nierdzewna
 stainless steel
 нержавеющая сталь



Półka pod klawiaturę z prowadnicą kulkową 27 mm
 Keyboard shelf with 27 mm drawer slide
 Полка для клавиатуры с шариковой направляющей 27 мм

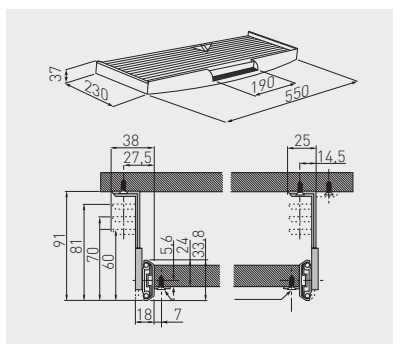

PU-KEY027-20	czarny / black / чёрны	tworzywo plastic пластмасса
PU-KEY027-60	szary / gray / серый	



Półka pod klawiaturę z podkładką na myszkę
 Keyboard shelf with mouse pad
 Полка для клавиатуры с подставкой для мыши

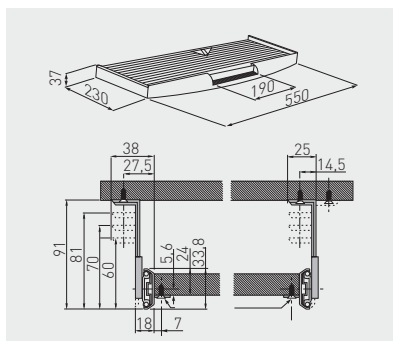

PU-KEYM27-20	czarny / black / чёрны	tworzywo plastic пластмасса
PU-KEYM27-60	szary / gray / серый	



Wózek pod komputer
Computer trolley
Передвижная подставка под компьютер

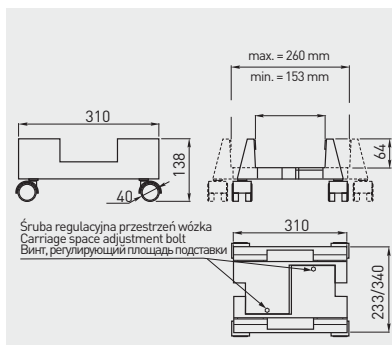
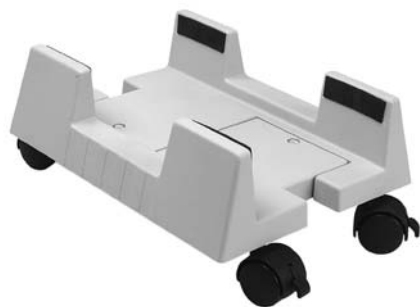

PU-PKO-00-20	czarny / black / чёрны	tworzywo plastic пластмасса
PU-PKO-00-60	szary / gray / серый	



Hub – 4 porty USB
Hub – 4 USB ports
Удлинитель на 4 входа USB

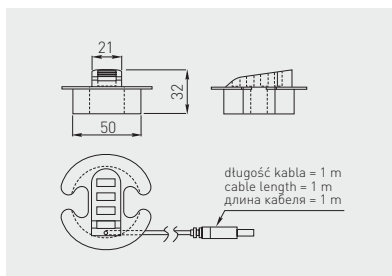

HB-USB-4X-60	srebrny / silver / серебряный	tworzywo plastic пластмасса
--------------	-------------------------------	--------------------------------



Przepust MERIDA 80
Desk cable outlet MERIDA 80
Пропуск для кабеля MERIDA 80

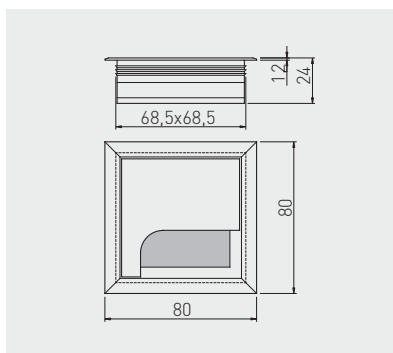

			
LB-K80X80-05	80 x 80	aluminium / aluminium / алюминий	
LB-K80X80-20		czarny / black / чёрный	
		aluminium aluminium алюминий	



Przepust MERIDA 100
Desk cable outlet MERIDA 100
Пропуск для кабеля MERIDA 100

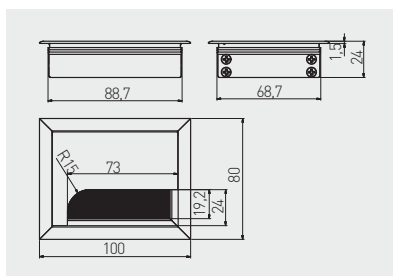





			
LB-80X100-05	80 x 100	aluminium / aluminium / алюминий	
LB-80X100-20		czarny / black / чёрный	
		aluminium aluminium алюминий	

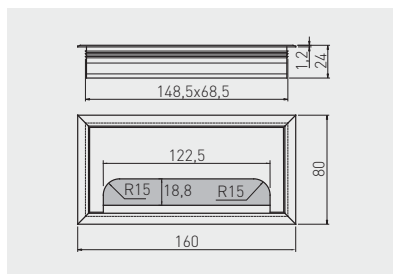

Przepust MERIDA 160
 Desk cable outlet MERIDA 160
 Пропуск для кабеля MERIDA 160





	 mm		
LB-80X160-05	80 x 160	aluminium / aluminium / алюминий	aluminium
LB-80X160-20		czarny / black / чёрный	aluminium aluminium алюминий

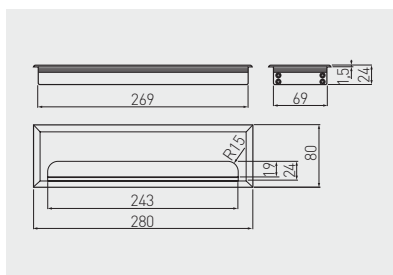

Przepust MERIDA 280
 Desk cable outlet MERIDA 280
 Пропуск для кабеля MERIDA 280



	 mm		
LB-80X280-05	80 x 280	aluminium / aluminium / алюминий	aluminium
LB-80X280-20		czarny / black / чёрный	aluminium aluminium алюминий



Przepust MERIDA 500
Desk cable outlet MERIDA 500
Пропуск для кабеля MERIDA 500

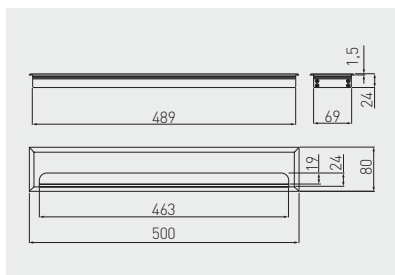

LB-80X500-05	80 x 500	aluminium / aluminium / алюминий	aluminium
LB-80X500-20		czarny / black / чёрный	aluminium алюминий



Przepust LBF
Desk cable grommet LBF
Пропуск для кабеля LBF

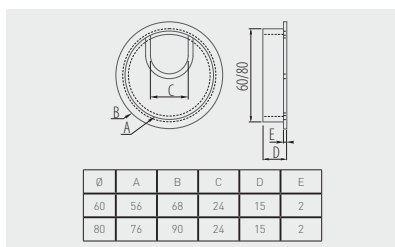

PM-LBF160-01	60	chrom / chrome / хром	ZnAl
PM-LBF160-02		satyna / satin / сатин	
PM-LBF160-05		aluminium / aluminium / алюминий	
PM-LBF160-06		stal szcztokowana / brushed steel / шлифованная сталь	
PM-LBF180-01	80	chrom / chrome / хром	
PM-LBF180-02		satyna / satin / сатин	
PM-LBF180-05		aluminium / aluminium / алюминий	
PM-LBF180-06		stal szcztokowana / brushed steel / шлифованная сталь	



Przepust PLF
 Desk cable grommet PLF
 Пропуск для кабеля PLF

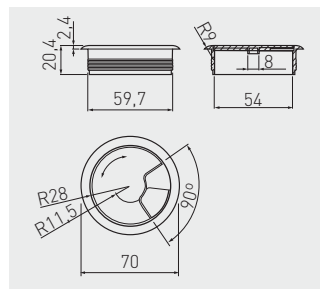

PM-PLFI60-05	aluminium / aluminium / алюминий	tworzywo plastic пластмасса
PM-PLFI60-10	biały / white / белый	
PM-PLFI60-20	czarny / black / чёрный	
PM-PLFI60-30	szary / gray / серый	
PM-PLFI60-43	jasny brąz / light brown / светло-коричневый	
PM-PLFI60-45	orzech / walnut / цвет орех	
PM-PLFI60-47	buk / beech / бук	
PM-PLFI60-49	klon / maple / клен	
PM-PLFI60-50	beż / beige / бежевый	
PM-PLFI60-51	kalwados / calvados / кальвадос	



* Produkt dostępny na indywidualne zamówienie / Available for special orders / Товар доступен под заказ

Zamek K-138
Lock K-138
Замок K-138

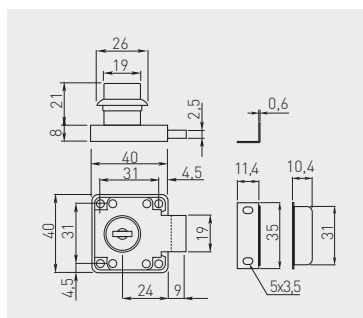

ZZ-KM-138-01



chrom / chrome / хром



ZnAl, stal / ZnAl, steel / ZnAl, сталь

Zamek Z-138 z kluczem łamanym
Lock Z-138 with folding key
Замок Z-138 со складным ключом

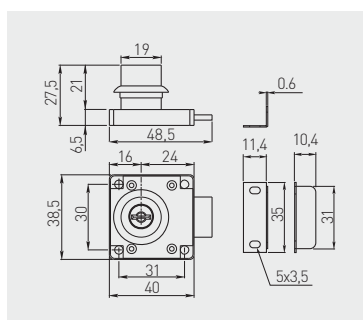

ZZ-ZN-138-01



chrom / chrome / хром



ZnAl, stal / ZnAl, steel / ZnAl, сталь

Zamek C-138 z kluczem cyfrowym
 Lock C-138 with key
 Замок C-138 с цифровым ключом

Kompatybilny z kluczem MASTER
 Compatible with MASTER key
 Подходит для ключа MASTER

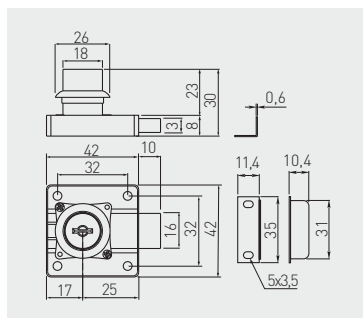

ZZ-CF-138-01



chrom / chrome / хром



ZnAl, stal / ZnAl, steel / ZnAl, сталь

Klucz MASTER do zamka C-138
 MASTER key for C-138 lock
 Ключ MASTER к замку C-138



ZZ-KLMASTER



chrom / chrome / хром



ZnAl, stal / ZnAl, steel / ZnAl, сталь

Zamek Z-338 zatrzaskowy
 Square lock Z-338
 Замок Z-338 с защёлкой

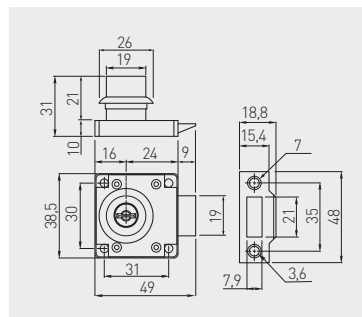

ZZ-ZN-338-01



chrom / chrome / хром



ZnAl, stal / ZnAl, steel / ZnAl, сталь

Zamek B-105 bolcowy
 Pin lock B-105
 Замок B-105 кнопочный

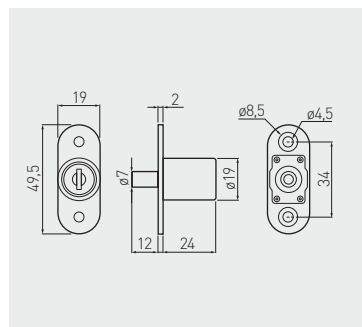

ZZ-B0-105-01







chrom / chrome / хром

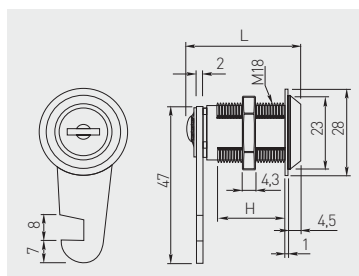

ZnAl, stal / ZnAl, steel / ZnAl, сталь

Zamek Z-103 skrzynkowy
 Box lock Z-103
 Замок Z-103



	 L mm	 H mm		
ZZ-16-103-01	27	12	chrom / chrome / хром	ZnAl, stal / ZnAl, steel / ZnAl, сталь
ZZ-20-103-01	30	16,5		
ZZ-30-103-01	40	26,5		

Zamek S-409 do szyb
 Glass door lock S-409
 Замок S-409 для стеклянных дверей

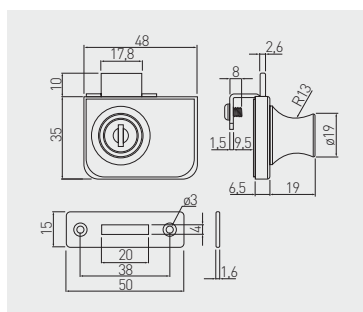

Zastosowanie do szkła 4 – 8 mm
 For 4 – 8 mm glass
 Толщина стекла 4 – 8 мм

		
ZZ-SZ-409-01	chrom / chrome / хром	ZnAl, stal / ZnAl, steel / ZnAl, сталь

Zamek M-201
Lock M-201
Замок M-201

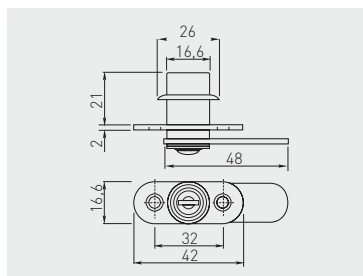

ZZ-M0-201-01

chrom / chrome / хром

ZnAl, stal, plastik / ZnAl, steel, plastic / ZnAl, сталь, пластмасса

Zamek Z-202 żaluzjowy
Double hook lock Z-202
Замок Z-202 жалюзийный

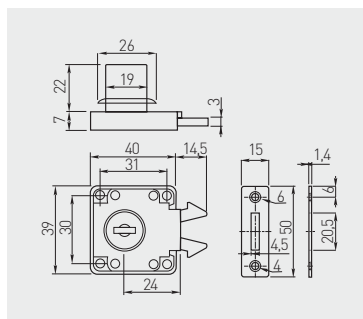

ZZ-Z0-202-01

chrom / chrome / хром

ZnAl, stal, plastik / ZnAl, steel, plastic / ZnAl, сталь, пластмасса

Zamek G-328 grzbietowy
Sliding glass door lock G-328
Замок G-328 внутренний

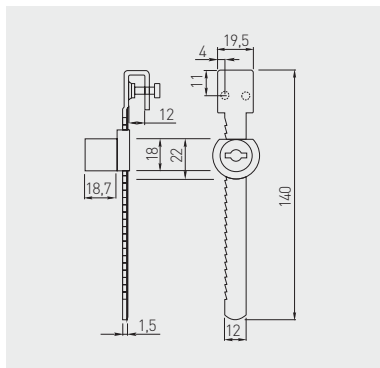

Zastosowanie do szkła 4 - 8 mm
For 4 - 8 mm glass
Толщина стекла 4 - 8 мм



ZZ-G0-328-01



chrom / chrome / хром



ZnAl, stal / ZnAl, steel / ZnAl, сталь

Zamek baskwilowy
Espagnolette lock
Замок шпингалетный

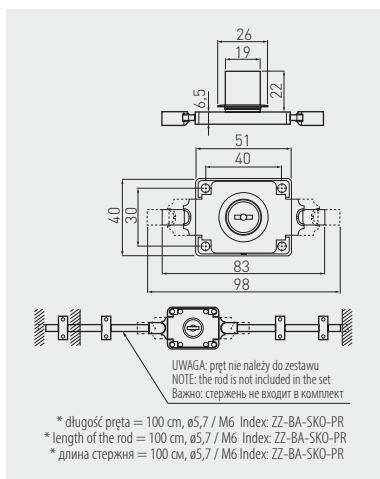

ZZ-BA-SKO-01

chrom / chrome / хром



ZZ-BA-SKO-PR

ocynk / galvanized / гальваника



stal / steel / сталь

Zamek C-288 centralny
Cabinet drawer lock C-288
Замок C-288 центральный боковой

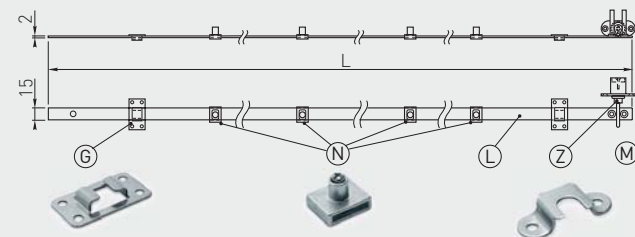

Skład zestawu / Set includes / Состав набора:

- Ⓒ Mocowanie listwy / Slat fixing / Крепление планки
- Ⓓ Blokady szuflady / Drawer locking mechanism / Блокада ящика
- Ⓕ Listwa zamka / Lock slat / Планка замка
- Ⓖ Zamek / Lock / Замок
- Ⓜ Zaczep / Hook / Зацепка

Model	C5	C6	C8	C1
L	500	600	800	1200
N	3	3	4	4
M	3	3	4	4
G	2	2	3	3

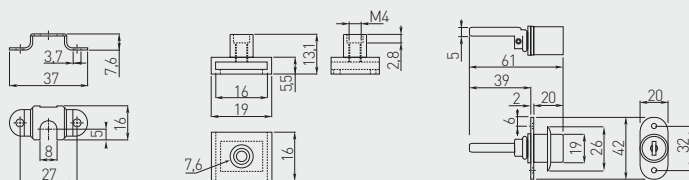

Model	Length (mm)	Material	Finish
ZZ-C5-288-01	500	chrom / chrome / хром	ZnAl, stal / ZnAl, steel / ZnAl, сталь
ZZ-C6-288-01	600		
ZZ-C8-288-01	800		
ZZ-C1-288-01	1200		
ZZ-SP-105-05	-	srebrny / silver / серебристый	stal, plastik / steel, plastic / сталь, пластмасса
ZZ-SP-KLMASTER	-	chrom / chrome / хром	

Kratka wentylacyjna
Plinth vent
Вентиляционная решётка

NEW

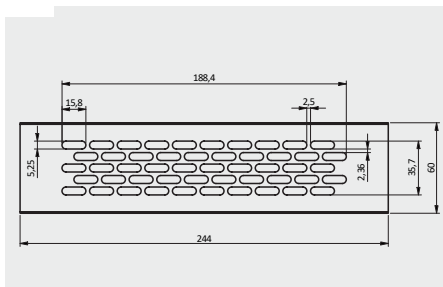





KK-W60245-M0	245	aluminium / aluminium / алюминий	aluminium aluminium алюминий
KK-W60245-M1		biały / white / белый	
KK-W60245-M2		czarny / black / чёрный	
KK-W60245-M6		stal szorstkowana / brushed steel / шлифованная сталь	

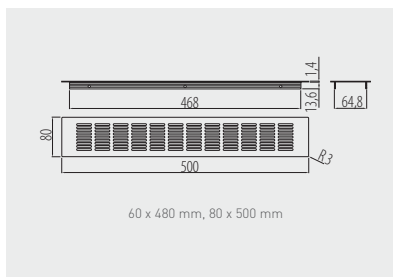

Kratka wentylacyjna D50-80
Plinth vent D50-80
Вентиляционная решётка D50-80







			
KK-D50-80-06	przepustowość powietrza – 108 cm ² air throughput – 108 cm ² прохождение воздушного потока – 108 см ²	stal szczotkowana brushed steel шлифованная сталь	aluminium aluminium алюминий

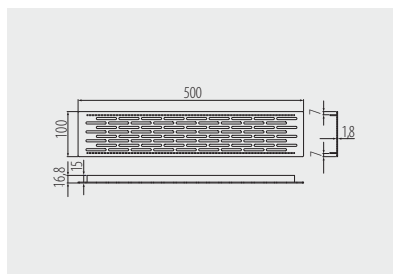

Kratka wentylacyjna D50-100
Plinth vent D50-100
Вентиляционная решётка D50-100







			
KK-D50100-06	przepustowość powietrza – 130 cm ² air throughput – 130 cm ² прохождение воздушного потока – 130 см ²	stal szczotkowana brushed steel шлифованная сталь	aluminium aluminium алюминий

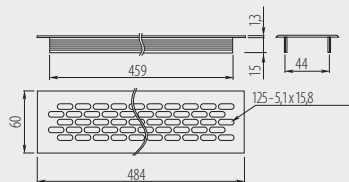

Kratka wentylacyjna W60
Plinth vent W60
Вентиляционная решётка W60



			
KK-W60800-M0	przepustowość powietrza – 94 cm ² air throughput – 94 cm ²	szary / gray / серый	aluminium aluminium
KK-W60800-M1	прохождение воздушного потока – 94 см ²	biały / white / белый	aluminium алюминий



Kratka wentylacyjna W80
Plinth vent W80
Вентиляционная решётка W80

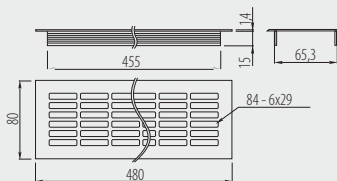
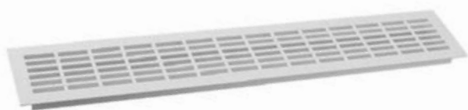





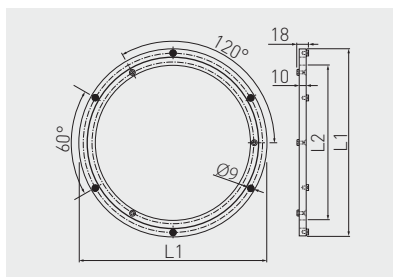

			
KK-W80800-D0	przepustowość powietrza – 146 cm ² air throughput – 146 cm ²	szary / gray / серый	aluminium aluminium
KK-W80800-D1	прохождение воздушного потока – 146 см ²	biały / white / белый	aluminium алюминий



Obrotnica okrągła
Round swivel bracket
Круглый поворотный кронштейн







		 L1 mm	 L2 mm	 kg		
OM-OBO300-05		300	248	60	aluminium aluminium алюминий	aluminium aluminium алюминий
OM-OBO400-05		400	338	100		

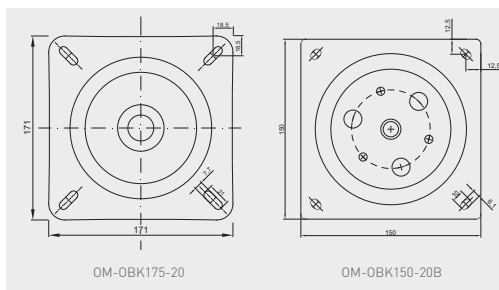

Obrotnica kwadratowa
Square swivel bracket
Поворотный кронштейн, квадратный



		 kg		
OM-OBK150-20B		50	czarny black чёрный	stal steel сталь
OM-OBK175-20*		100		





MB
MILNER BROS.

**AKCESORIA DEKORACYJNE
DECORATIVE ACCESSORIES
ЛИЦЕВАЯ ФУРНИТУРА**

Uchwyty Handles Ручки	246 – 323
Wieszaki Hooks Крючки	323 – 338
Wsporniki Shelf supports Полкодержатели	339 – 345
Nóżki meblowe Furniture legs Мебельные ножки	346 – 370
Nogi meblowe Furniture legs Мебельные опоры	371 – 387
Rolki meblowe Furniture castors Мебельные колёсики	388 – 393





GTV

Uchwyt CLEO
Handle CLEO
Ручка CLEO

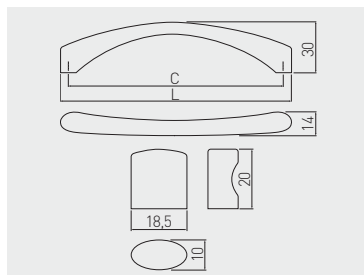

C mm	L mm				
		chrom chrome хром	aluminium aluminium алюминий	stal szczerkowana brushed steel шлифованная сталь	ZnAl
128	137	UZ-CLEO-128-01	UZ-CLEO-128-05	UZ-CLEO-128-06	
160	169	UZ-CLEO-160-01	UZ-CLEO-160-05	UZ-CLEO-160-06	
192	201	UZ-CLEO-192-01	UZ-CLEO-192-05	UZ-CLEO-192-06	
gatka knob ручка		GZ-CLEO-1-01	GZ-CLEO-1-05	GZ-CLEO-1-06	

Uchwyt VETA
Handle VETA
Ручка VETA

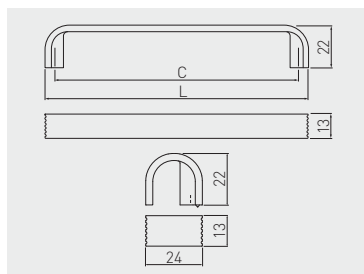

C mm	L mm				
		chrom chrome хром	aluminium aluminium алюминий	czarny chrom black chrome чёрный хром	ZnAl
128	138	UZ-VETA-128-01	UZ-VETA-128-05	UZ-VETA-128-12	
160	170	UZ-VETA-160-01	UZ-VETA-160-05	UZ-VETA-160-12	
320	330	UZ-VETA-320-01	UZ-VETA-320-05	UZ-VETA-320-12	

Uchwyt MONZA
Handle MONZA
Ручка MONZA

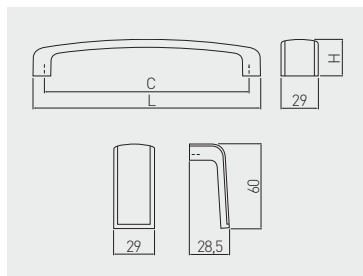

C mm	L mm	H mm				
16	29	28,5	stal szorstkowana, chrom brushed steel, chrome шлифованная сталь, хром	biały, chrom white, chrome белый, хром	czarny, chrom black, chrome чёрный, хром	ZnAl, aluminium ZnAl, aluminium ZnAl, алюминий
160	178	29	UZ-MONZA160-06	UZ-MONZA160-10	UZ-MONZA160-20	
256	274	33	UZ-MONZA256-06	UZ-MONZA256-10	UZ-MONZA256-20	
384	402	34	UZ-MONZA384-06	UZ-MONZA384-10	UZ-MONZA384-20	

Uchwyt MONA
Handle MONA
Ручка MONA

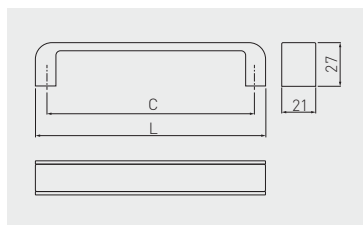

C mm	L mm			
128	142	chrom, biały chrome, white хром, белый	chrom, czarny chrome, black хром, чёрный	ZnAl
192	206	UZ-MONA-128-01-10	UZ-MONA-128-01-20	
256	270	UZ-MONA-192-01-10	UZ-MONA-192-01-20	
		UZ-MONA-256-01-10	UZ-MONA-256-01-20	

Uchwyt ASTI
Handle ASTI
Ручка ASTI

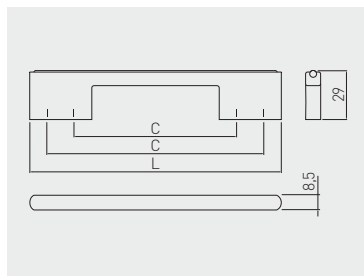

C mm	L mm		
		chrom chrome хром	ZnAl
96 / 128	148	UZ-ASTI096/128-01	
192 / 224	245	UZ-ASTI192/224-01	
288 / 320	340	UZ-ASTI288/320-01	

Uchwyt UZ-G2
Handle UZ-G2
Ручка UZ-G2

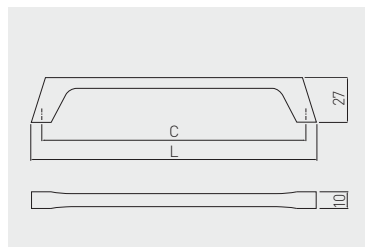

NEW



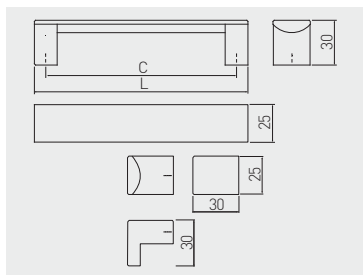

C mm	L mm			
		chrom chrome хром	ZnAl	
		stal szczotkowana brushed steel шлифованная сталь		
		czarny mat black matt чёрный матовый		
160	172	UZ-G2-160-01	UZ-G2-160-06	UZ-G2-160-20M
224	236	UZ-G2-224-01	UZ-G2-224-06	UZ-G2-224-20M

Uchwyt ARES
Handle ARES
Ручка ARES



C mm	L mm		
		czarny black чёрный	aluminium aluminium алюминий
96	111	UA-ARS096-20	
128	143	UA-ARS128-20	
160	175	UA-ARS160-20	
192	207	UA-ARS192-20	
224	239	UA-ARS224-20	

C mm	L mm		
		czarny black чёрный	aluminium aluminium алюминий
256	271	UA-ARS256-20	
320	335	UA-ARS320-20	
gatka knob ручка		UA-ARSG30-20	



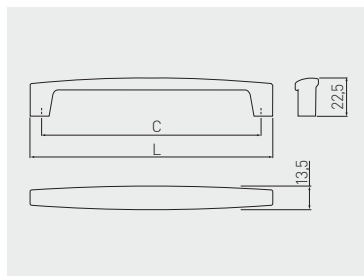

Uchwyt TIVOLI
Handle TIVOLI
Ручка TIVOLI

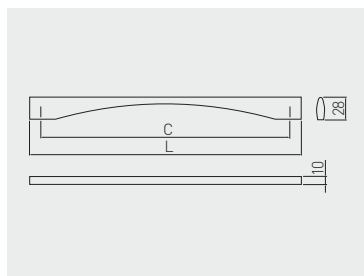

C mm	L mm				
		chrom chrome хром	czarny chrom black chrome чёрный хром	tytan titanium титан	ZnAl
192	206	UZ-TIVOL-192-01	UZ-TIVOL-192-12	UZ-TIVOL-192-13	
320	334	UZ-TIVOL-320-01	UZ-TIVOL-320-12	UZ-TIVOL-320-13	

Uchwyt PRATO
Handle PRATO
Ручка PRATO



C mm	L mm				
		chrom chrome хром	stal szcztokowana brushed steel шлифованная сталь		ZnAl
160	189	UZ-PRATO-160-01	UZ-PRATO-160-06		
320	349	UZ-PRATO-320-01	UZ-PRATO-320-06		

Uchwyt BAGIO
Handle BAGIO
Ручка BAGIO

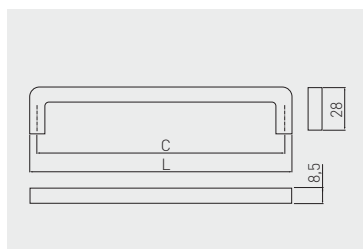

C mm	L mm					
		chrom chrome хром	antyczny miedź antique brass античная латунь	aluminium aluminium алюминий	stal szorstkowana brushed steel шлифованная сталь	ZnAl
128	136	UZ-BAGIO-128-01	UZ-BAGIO-128-04	UZ-BAGIO-128-05	UZ-BAGIO-128-06	
160	168	UZ-BAGIO-160-01	UZ-BAGIO-160-04	UZ-BAGIO-160-05	UZ-BAGIO-160-06	
192	200	UZ-BAGIO-192-01	UZ-BAGIO-192-04	UZ-BAGIO-192-05	UZ-BAGIO-192-06	
320	328	UZ-BAGIO-320-01	UZ-BAGIO-320-04	UZ-BAGIO-320-05	UZ-BAGIO-320-06	

C mm	L mm					
		antyczne srebro antique silver античное серебро	tytan szorstkowany brushed titanium шлифованный титан	czarny mat black matt чёрный матовый		ZnAl
128	136	UZ-BAGIO-128-07	UZ-BAGIO-128-11	UZ-BAGIO-128-20M		
160	168	UZ-BAGIO-160-07	UZ-BAGIO-160-11	UZ-BAGIO-160-20M		
192	200	UZ-BAGIO-192-07	UZ-BAGIO-192-11	UZ-BAGIO-192-20M		
320	328	UZ-BAGIO-320-07	UZ-BAGIO-320-11	UZ-BAGIO-320-20M		



Uchwyt ANCONA
Handle ANCONA
Ручка ANCONA

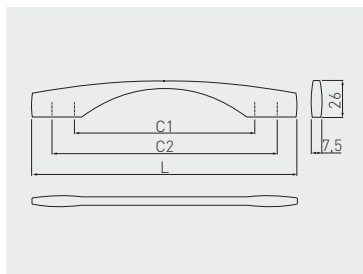

C1 mm	C2 mm	L mm				
			chrom chrome хром	aluminium aluminium алюминий	stal szcztokowana brushed steel шлифованная сталь	ZnAl
128	160	190	UZ-ANCON-128-01	UZ-ANCON-128-05	UZ-ANCON-128-06	
192	224	254	UZ-ANCON-192-01	UZ-ANCON-192-05	UZ-ANCON-192-06	
256	288	318	UZ-ANCON-256-01	UZ-ANCON-256-05	UZ-ANCON-256-06	

Uchwyt KATANIA
Handle KATANIA
Ручка KATANIA

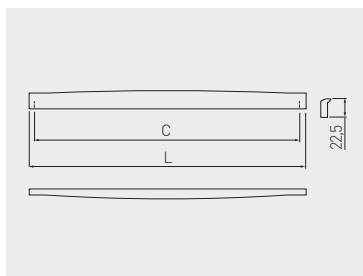

C mm	L mm			
		chrom chrome хром	czarny chrom black chrome чёрный хром	ZnAl
320	334	UZ-KATAN-320-01	UZ-KATAN-320-12	

Uchwyt UZ-40
Handle UZ-40
Ручка UZ-40

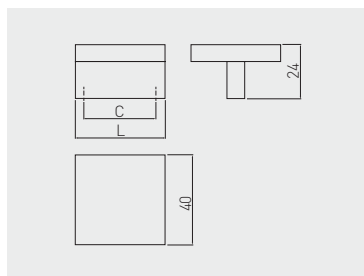

NEW

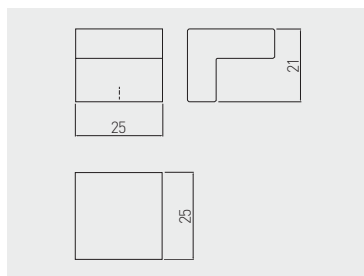

 C mm		 L mm					
		chrom chrome хром	satyna satin сатин	aluminium aluminium алюминий	stal szczotkowana brushed steel шлифованная сталь	czarny mat black matt чёрный матовый	ZnAl
32	40	UZ-40-032-01	UZ-40-032-02	UZ-40-032-05	UZ-40-032-06	UZ-40-032-20M	

Uchwyt UZ-55
Handle UZ-55
Ручка UZ-55



 L mm				
		chrom chrome хром	aluminium aluminium алюминий	ZnAl
gatka knob ручка	25	UZ-55-025-01	UZ-55-025-05	

Uchwył UZ-60
Handle UZ-60
Ручка UZ-60

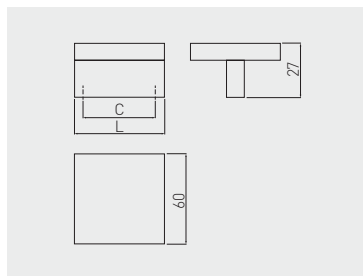
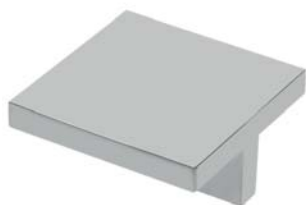

C mm	L mm					
		chrom chrome хром	satyna satin сатин	aluminium aluminium алюминий	stal szcztokowana brushed steel шлифованная сталь	ZnAl
32	60	UZ-60-032-01	UZ-60-032-02	UZ-60-032-05	UZ-60-032-06	

Uchwył UZ-133
Handle UZ-133
Ручка UZ-133



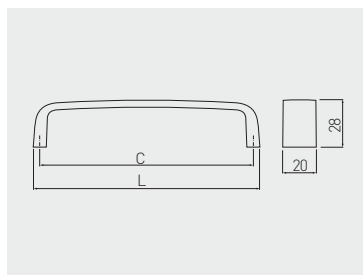

NEW

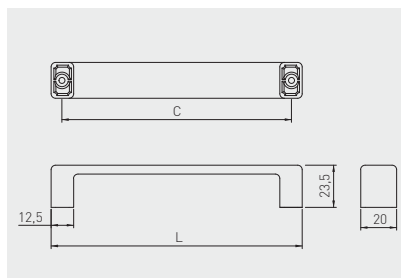

C mm	L mm						
		chrom chrome хром	satyna satin сатин	aluminium aluminium алюминий	stal szcztokowana brushed steel шлифованная сталь	czarny mat black matt чёрный матовый	ZnAl
128	135	UZ-133128-01	UZ-133128-02	UZ-133128-05	UZ-133128-06	UZ-133128-20M	

Uchwyt MODENA
Handle MODENA
Ручка MODENA





 C mm	 L mm					
C	L	chrom chrome хром	aluminium aluminium алюминий	stal szczotkowana brushed steel шлифованная сталь	czarny mat black matt чёрный матовый	ZnAl
128	140	UZ-MODEN-128-01	UZ-MODEN-128-05	UZ-MODEN-128-06	UZ-MODEN-128-20M	
160	172	UZ-MODEN-160-01	UZ-MODEN-160-05	UZ-MODEN-160-06	UZ-MODEN-160-20M	
192	204	UZ-MODEN-192-01	UZ-MODEN-192-05	UZ-MODEN-192-06	UZ-MODEN-192-20M	



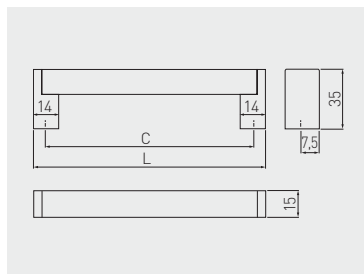

Uchwyt UZ-334
Handle UZ-334
Ручка UZ-334

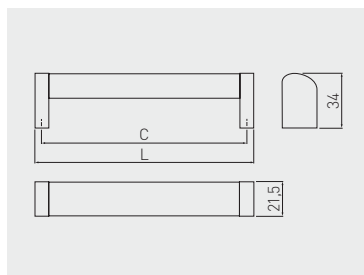

C mm	L mm		
		stal szczotkowana brushed steel шлифованная сталь	ZnAl, stal ZnAl, steel ZnAl, сталь
128	144	UZ-334128-06	
160	175	UZ-334160-06	
192	206	UZ-334192-06	
256	272	UZ-334256-06	
320	335	UZ-334320-06	

Uchwyt UZ-335
Handle UZ-335
Ручка UZ-335



C mm	L mm		
		stal szczotkowana brushed steel шлифованная сталь	ZnAl, stal ZnAl, steel ZnAl, сталь
128	137	UZ-335128-06	
160	169	UZ-335160-06	
192	201	UZ-335192-06	
256	265	UZ-335256-06	

Uchwyt UZ-336
Handle UZ-336
Ручка UZ-336

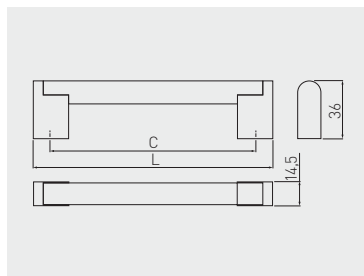

C mm	L mm			
		stal szcztokowana brushed steel шлифованная сталь		
128	148	UZ-336128-06	ZnAl, stal ZnAl, steel ZnAl, сталь	
160	182	UZ-336160-06		
192	213	UZ-336192-06		
256	276	UZ-336256-06		
320	340	UZ-336320-06		
416	436	UZ-336416-06		
480	500	UZ-336480-06		

Uchwyt UZ-682
Handle UZ-682
Ручка UZ-682

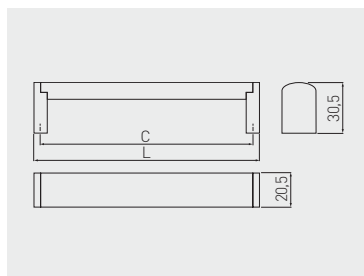

C mm	L mm				C mm	L mm			
		stal szcztokowana brushed steel шлифованная сталь					stal szcztokowana brushed steel шлифованная сталь		
128	136	UZ-682128-06	stal, ZnAl steel, ZnAl сталь, ZnAl		256	266	UZ-682256-06	stal, ZnAl steel, ZnAl сталь, ZnAl	
160	170	UZ-682160-06			320	329	UZ-682320-06		
192	209	UZ-682192-06			416	425	UZ-682416-06		
224	232	UZ-682224-06			480	489	UZ-682480-06		

Uchwyt MILANO
Handle MILANO
Ручка MILANO

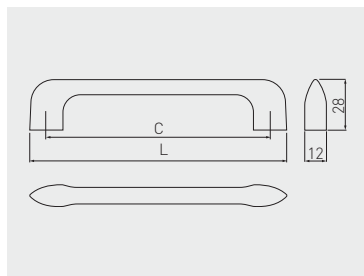

C
mm

L
mm



C	L	chrom chrome хром	aluminium aluminium алюминий	stal szczotkowana brushed steel шлифованная сталь	czarny mat black matt чёрный матовый	ZnAl
128	146	UZ-MILAN-128-01	UZ-MILAN-128-05	UZ-MILAN-128-06	UZ-MILAN-128-20M	
256	274	UZ-MILAN-256-01	UZ-MILAN-256-05	UZ-MILAN-256-06	UZ-MILAN-256-20M	
gałka knob ручка		GZ-MILAN-32-01	GZ-MILAN-32-05	GZ-MILAN-32-06	GZ-MILAN-32-20M	

Uchwyt OCTAVIO
Handle OCTAVIO
Ручка OCTAVIO

NEW

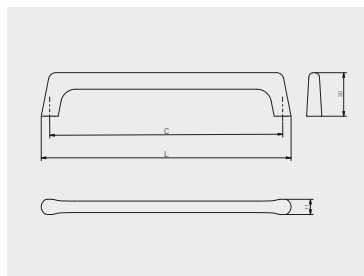

C
mm

L
mm



C	L	chrom chrome хром	stal szczotkowana brushed steel шлифованная сталь	złoty szczotkowany brushed gold матовое золото	czarny mat black matt чёрный матовый	ZnAl
128	139	UZ-OCTAVIO-128-01	UZ-OCTAVIO-128-06	UZ-OCTAVIO-128-18	UZ-OCTAVIO-128-20M	
160	171	UZ-OCTAVIO-160-01	UZ-OCTAVIO-160-06	UZ-OCTAVIO-160-18	UZ-OCTAVIO-160-20M	
192	203	UZ-OCTAVIO-192-01	UZ-OCTAVIO-192-06	UZ-OCTAVIO-192-18	UZ-OCTAVIO-192-20M	

Uchwyt CAPRI
Handle CAPRI
Ручка CAPRI

NEW

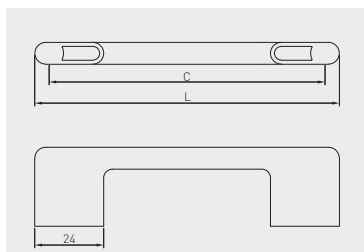

C
mm

L
mm



C	L	chrom chrome хром	satyna satin сатин	aluminium aluminium алюминий	stal szorstkowana brushed steel шлифованная сталь	czarny mat black matt чёрный матовый	
96	106	UZ-CAPRI-96-01	UZ-CAPRI-96-02	UZ-CAPRI-96-05	UZ-CAPRI-96-06	UZ-CAPRI-96-20M	ZnAl
128	138	UZ-CAPRI-128-01	UZ-CAPRI-128-02	UZ-CAPRI-128-05	UZ-CAPRI-128-06	UZ-CAPRI-128-20M	
160	170	UZ-CAPRI-160-01	UZ-CAPRI-160-02	UZ-CAPRI-160-05	UZ-CAPRI-160-06	UZ-CAPRI-160-20M	
192	202	UZ-CAPRI-192-01	UZ-CAPRI-192-02	UZ-CAPRI-192-05	UZ-CAPRI-192-06	UZ-CAPRI-192-20M	
256	266	UZ-CAPRI-256-01	UZ-CAPRI-256-02	UZ-CAPRI-256-05	UZ-CAPRI-256-06	UZ-CAPRI-256-20M	
320	330	UZ-CAPRI-320-01	UZ-CAPRI-320-02	UZ-CAPRI-320-05	UZ-CAPRI-320-06	UZ-CAPRI-320-20M	

MODERN



Uchwyt UZ-819
Handle UZ-819
Ручка UZ-819

NEW

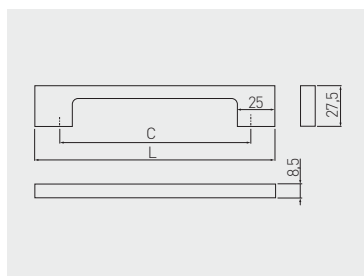

C	L	chrom chrome хром	satyna satin сатин	aluminium aluminium алюминий	stal szcztokowana brushed steel шлифованная сталь	antyczne srebro antique silver античное серебро	biały white белый	
96	129	UZ-819096-01	UZ-819096-02	UZ-819096-05	UZ-819096-06	UZ-819096-07	UZ-819096-10	ZnAl
128	161	UZ-819128-01	UZ-819128-02	UZ-819128-05	UZ-819128-06	UZ-819128-07	UZ-819128-10	
160	193	UZ-819160-01	UZ-819160-02	UZ-819160-05	UZ-819160-06	UZ-819160-07	UZ-819160-10	
192	225	UZ-819192-01	UZ-819192-02	UZ-819192-05	UZ-819192-06	UZ-819192-07	UZ-819192-10	
256	289	UZ-819256-01	UZ-819256-02	UZ-819256-05	UZ-819256-06	UZ-819256-07	UZ-819256-10	
320	353	UZ-819320-01	UZ-819320-02	UZ-819320-05	UZ-819320-06	UZ-819320-07	UZ-819320-10	



C	L	czarny chrom black chrome чёрный хром	antyczna miedź antique copper античная медь	miedź copper медь	złoty mosiądz gold brass золотая латунь	czarny black чёрный	
96	129	UZ-819096-12	UZ-819096-14	-	-	UZ-819096-20	ZnAl
128	161	UZ-819128-12	UZ-819128-14	UZ-819128-15	UZ-819128-16	UZ-819128-20	
160	193	UZ-819160-12	UZ-819160-14	UZ-819160-15	UZ-819160-16	UZ-819160-20	
192	225	UZ-819192-12	UZ-819192-14	UZ-819192-15	UZ-819192-16	UZ-819192-20	
256	289	UZ-819256-12	UZ-819256-14	UZ-819256-15	UZ-819256-16	UZ-819256-20	
320	353	UZ-819320-12	UZ-819320-14	-	-	UZ-819320-20	

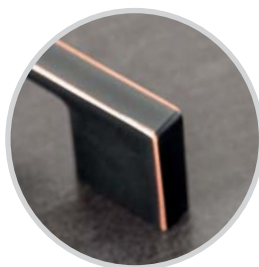

antyczna miedź
antique copper
античная медь



miedź
copper
медь



Uchwyt UA-A3
Handle UA-A3
Ручка UA-A3

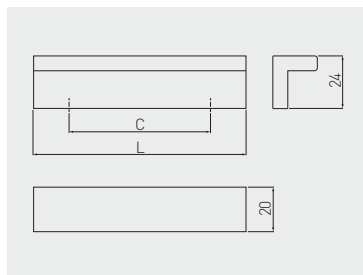

C mm	L mm		
96	128	aluminium aluminium алюминий	aluminium aluminium алюминий
128	160	UA-A3-096128 UA-A3-128160*	

* Produkt dostępny na indywidualne zamówienie / Available for special orders / Товар доступен под заказ

Uchwyt UA-B311
Handle UA-B311
Ручка UA-B311

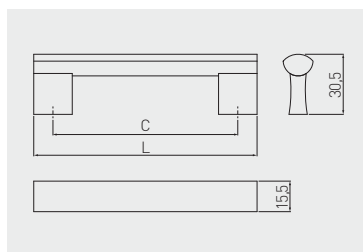

C mm	L mm				
96	116	chrom chrome хром	aluminium aluminium алюминий	czarny black чёрный	aluminium aluminium алюминий
96	116	UA-B31109601*	UA-B0-311096	UA-B0-311096-20M	
128	148	UA-B31112801	UA-B0-311128	UA-B0-311128-20M	
160	180	UA-B31116001	UA-B0-311160	UA-B0-311160-20M	
192	212	UA-B31119201	UA-B0-311192	UA-B0-311192-20M	
224	244	UA-B31122401	UA-B0-311224	UA-B0-311224-20M	
256	276	UA-B31125601	UA-B0-311256	UA-B0-311256-20M	
288	307	UA-B31128801*	UA-B0-311288	UA-B0-311288-20M*	
320	340	UA-B31132001	UA-B0-311320	UA-B0-311320-20M	
480	500	UA-B31148001*	UA-B0-311480	UA-B0-311480-20M*	

* Produkt dostępny na indywidualne zamówienie / Available for special orders / Товар доступен под заказ



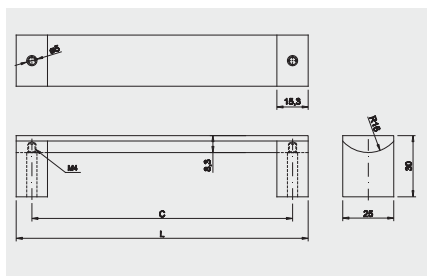

Uchwyt UA-B337
Handle UA-B337
Ручка UA-B337

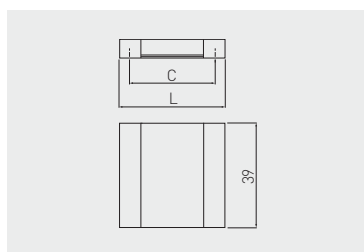

 C mm	 L mm		
C	L	aluminium aluminium алюминий	aluminium aluminium алюминий
128	143	UA-B0-337128	
160	175	UA-B0-337160	
192	207	UA-B0-337192	
224	239	UA-B0-337224	
256	271	UA-B0-337256	
320	335	UA-B0-337320	





Uchwyt UA-114
Handle UA-114
Ручка UA-114

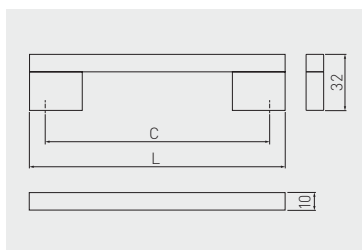

 C mm	 L mm		
		aluminium aluminium алюминий	aluminium aluminium алюминий
32	39	UA-AA-114-05	

Uchwyt UA-18
Handle UA-18
Ручка UA-18





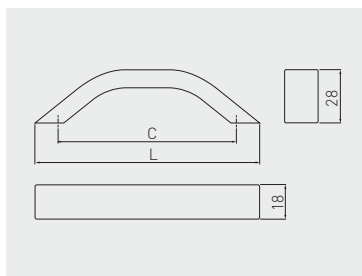

 C mm	 L mm		
		chrom chrome хром	aluminium aluminium алюминий
128	146	UA-A18128-01	UA-18-128146
160	178	UA-A18160-01	UA-18-160178
192	210	UA-A18192-01	UA-18-192210
224	242	UA-A18224-01	UA-18-224242
256	274	UA-A18256-01	UA-18-256274
320	338	UA-A18320-01	UA-18-320338
400	418	-	UA-18-400418

aluminium
aluminium
алюминий

Uchwyt UA-313
Handle UA-313
Ручка UA-313



 C mm	 L mm		
		aluminium aluminium алюминий	
128	150	UA-00-313128	aluminium aluminium алюминий
160	182	UA-00-313160	
192	214	UA-00-313192	

28

18

Uchwyt UA-319
Handle UA-319
Ручка UA-319

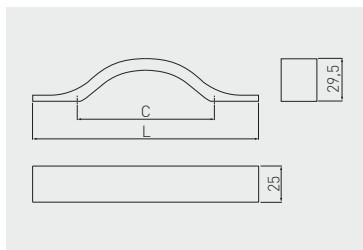

C mm	L mm		
		aluminium aluminium алюминий	aluminium aluminium алюминий
96	158	UA-00-319096	
128	189	UA-00-319128	
160	231	UA-00-319160	

Uchwyt DOPPIO
Handle DOPPIO
Ручка DOPPIO

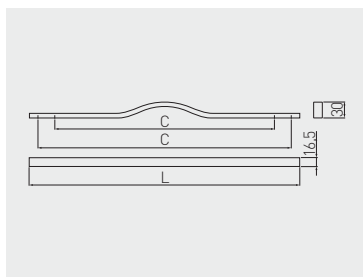

C mm	L mm		
		chrom, aluminium chrome, aluminium хром, алюминий	aluminium aluminium алюминий
192 / 224	256	UA-DOPPIO192-01	
416 / 480	512	UA-DOPPIO416-01	

Uchwyt VITO
Handle VITO
Ручка VITO

NEW

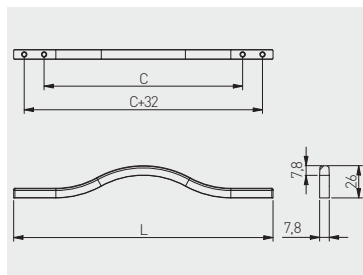

 C mm	 L mm				
		chrom chrome хром	aluminium aluminium алюминий	antyczne srebro antique silver античное серебро	ZnAl
160	210	UZ-VITO-160-01	UZ-VITO-160-05	UZ-VITO-160-07	
288	340	UZ-VITO-288-01	UZ-VITO-288-05	UZ-VITO-288-07	

 C mm	 L mm				
		czarny chrom black chrome чёрный хром	złoty mosiądz gold brass золотая латунь	czarny mat black matt чёрный матовый	ZnAl
160	210	UZ-VITO-160-12	UZ-VITO-160-16	UZ-VITO-160-20M	
288	340	UZ-VITO-288-12	UZ-VITO-288-16	UZ-VITO-288-20M	



Uchwyt FLAVIO
Handle FLAVIO
Ручка FLAVIO

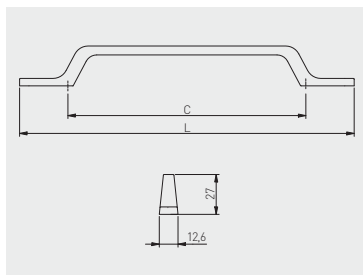

C mm	L mm					
		chrom chrome хром	stal szcztokowana brushed steel шлифованная сталь	złoty mosiądz golden brass золотая латунь	czarny mat black matt чёрный матовый	ZnAl
96	161	UZ-FLAVIO-96-01	UZ-FLAVIO-96-06	UZ-FLAVIO-96-16	UZ-FLAVIO-96-20M	
128	193	UZ-FLAVIO-128-01	UZ-FLAVIO-128-06	UZ-FLAVIO-128-16	UZ-FLAVIO-128-20M	
160	225	UZ-FLAVIO-160-01	UZ-FLAVIO-160-06	UZ-FLAVIO-160-16	UZ-FLAVIO-160-20M	

Uchwyt THIN
Handle THIN
Ручка THIN

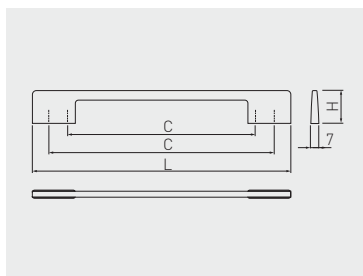

C mm	L mm	H mm				
			chrom chrome хром	aluminium aluminium алюминий	stal szcztokowana brushed steel шлифованная сталь	ZnAl
96/128	156	24	UZ-TH096128-01	UZ-TH096128-05	UZ-TH096128-06	
160/192	220	28	UZ-TH160192-01	UZ-TH160192-05	UZ-TH160192-06	
288/320	348	28	UZ-TH288320-01	-	UZ-TH288320-06	

Uchwyt UA-337
Handle UA-337
Ручка UA-337

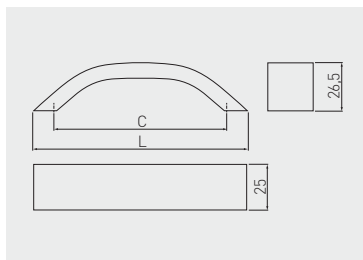

C mm	L mm			
		aluminium aluminium алюминий	czarny black чёрный	aluminium aluminium алюминий
96	116	UA-00-337096	UA-00-337096-20M	
128	146	UA-00-337128	UA-00-337128-20M	
160	180	UA-00-337160	UA-00-337160-20M	
192	212	UA-00-337192	UA-00-337192-20M	
224	244	UA-00-337224	UA-00-337224-20M	
256	275	UA-00-337256	UA-00-337256-20M	
320	340	UA-00-337320	UA-00-337320-20M	

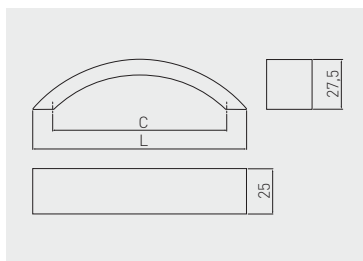

Uchwyt UA-338
Handle UA-338
Ручка UA-338

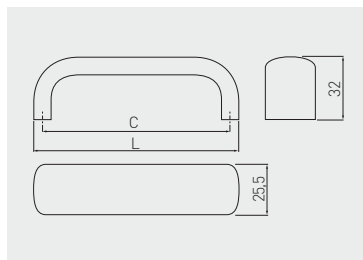

C mm	L mm			
		aluminium aluminium алюминий		aluminium aluminium алюминий
128	137	UA-00-338128		
160	169	UA-00-338160		

Uchwyt UA-340
Handle UA-340
Ручка UA-340



C mm	L mm		
		aluminium aluminium алюминий	aluminium aluminium алюминий
128	137	UA-00-340128	
160	169	UA-00-340160	
192	201	UA-00-340192	
224	233	UA-00-340224	
256	265	UA-00-340256	
320	329	UA-00-340320	



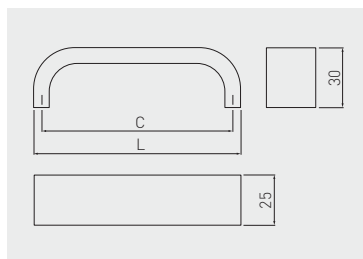

Uchwyt UA-347
Handle UA-347
Ручка UA-347

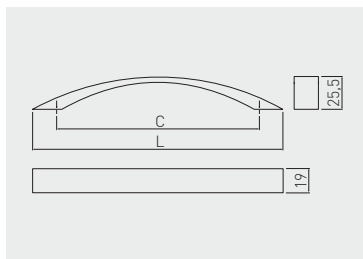

C mm	L mm		
		aluminium aluminium алюминий	aluminium aluminium алюминий
128	136	UA-00-347128	
160	168	UA-00-347160	
192	200	UA-00-347192	
224	232	UA-00-347224	
256	264	UA-00-347256	
320	328	UA-00-347320	

Uchwyt CALABRIA
Handle CALABRIA
Ручка CALABRIA



 C mm	 L mm		
		chrom chrome хром	stal szczotkowana brushed steel шлифованная сталь
160	195	UZ-CALABRIA160-01	UZ-CALABRIA160-06
192	224	UZ-CALABRIA192-01	UZ-CALABRIA192-06
224	258	UZ-CALABRIA224-01	UZ-CALABRIA224-06

ZnAl

Uchwyt GENUA
Handle GENUA
Ручка GENUA

NEW

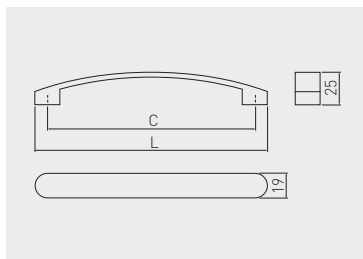

 C mm	 L mm				
		chrom chrome хром	satyna satin сатин	aluminium aluminium алюминий	czarny mat black matt чёрный матовый
128	148	UZ-GENUA128-01	UZ-GENUA128-02	UZ-GENUA128-05	UZ-GENUA128-20M
160	180	UZ-GENUA160-01	UZ-GENUA160-02	UZ-GENUA160-05	UZ-GENUA160-20M

ZnAl

Uchwyt G0
Handle G0
Ручка G0

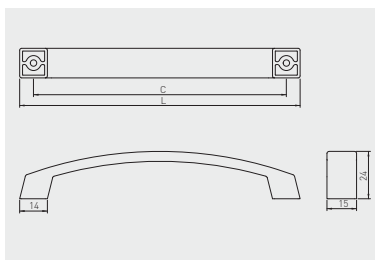

C mm	L mm				
		chrom chrome хром	aluminium aluminium алюминий	stal szczotkowana brushed steel шлифованная сталь	ZnAl
128	142	UZ-G0-128-01	UZ-G0-128-05	UZ-G0-128-06	
160	174	UZ-G0-160-01	UZ-G0-160-05	UZ-G0-160-06	
192	206	UZ-G0-192-01	UZ-G0-192-05	UZ-G0-192-06	
256	270	UZ-G0-256-01	UZ-G0-256-05	UZ-G0-256-06	

Uchwyt UZ-G1
Handle UZ-G1
Ручка UZ-G1

NEW

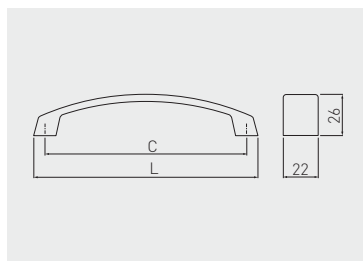

C mm	L mm					
		chrom chrome хром	aluminium aluminium алюминий	stal szczotkowana brushed steel шлифованная сталь	tytan titanium титан	czarny mat black matt чёрный матовый
128	142	UZ-G1-128-01	UZ-G1-128-05	UZ-G1-128-06	UZ-G1-128-13	UZ-G1-128-20M
160	174	UZ-G1-160-01	UZ-G1-160-05	UZ-G1-160-06	UZ-G1-160-13	UZ-G1-160-20M
192	206	UZ-G1-192-01	UZ-G1-192-05	UZ-G1-192-06	UZ-G1-192-13	UZ-G1-192-20M
256	270	UZ-G1-256-01	UZ-G1-256-05	UZ-G1-256-06	UZ-G1-256-13	UZ-G1-256-20M
320	334	UZ-G1-320-01	UZ-G1-320-05	UZ-G1-320-06	UZ-G1-320-13	UZ-G1-320-20M
416	430	UZ-G1-416-01	UZ-G1-416-05	UZ-G1-416-06	-	-

Uchwyt NORD
Handle NORD
Ручка NORD

NEW

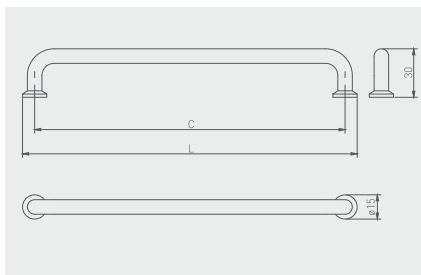

C	L	złoty szczotkowany brushed gold матовое золото	czarny mat black matt чёрный матовый	ZnAl
128	142	UZ-NORD-128-18	UZ-NORD-128-20M	
192	206	UZ-NORD-192-18	UZ-NORD-192-20M	
gatka knob ручка		GZ-NORD-1-18	GZ-NORD-1-20M	

Uchwyt VENICE
Handle VENICE
Ручка VENICE

NEW

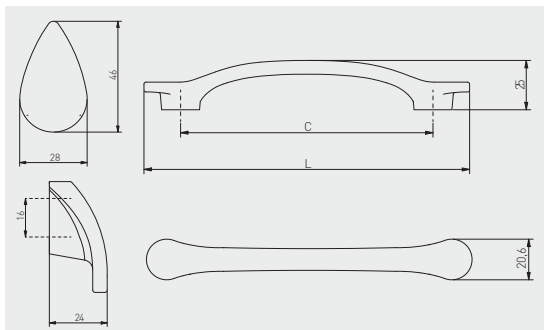

C	L	szampan champagne шампань	czarny mat black matt чёрный матовый	ZnAl
128	165	UZ-VENICE-128-90	UZ-VENICE-128-20M	
gatka knob ручка		GZ-VENICE-1-90	GZ-VENICE-1-20M	

Uchwyt OTTO
Handle OTTO
Ручка OTTO

NEW

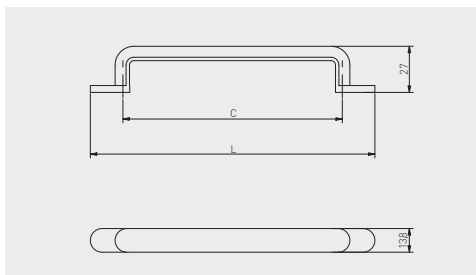

C mm	L mm				
		stal szczotkowana brushed steel шлифованная сталь	szampan champagne шампань	czarny mat black matt чёрный матовый	ZnAl
128	166	UZ-OTTO-128-06	UZ-OTTO-128-90	UZ-OTTO-128-20M	
160	198	UZ-OTTO-160-06	UZ-OTTO-160-90	UZ-OTTO-160-20M	

Uchwyt EVER
Handle EVER
Ручка EVER

NEW

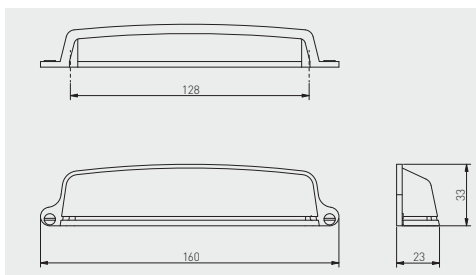

C mm	L mm			
		szampan champagne шампань	czarny mat black matt чёрный матовый	ZnAl
128	160	UZ-EVER-128-90	UZ-EVER-128-20M	

Uchwyt FLOW
Handle FLOW
Ручка FLOW

NEW

CLASSIC

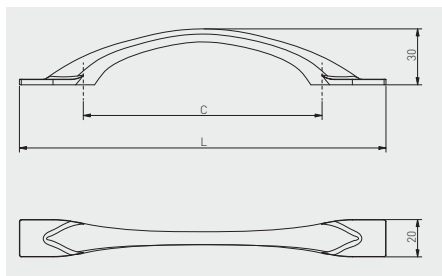

C mm	L mm				
		stal szczotkowana brushed steel шлифованная сталь	szampań champagne шампань	czarny mat black matt чёрный матовый	ZnAl
128	200	UZ-FLOW-128-06	UZ-FLOW-128-90	UZ-FLOW-128-20M	
192	270	UZ-FLOW-192-06	UZ-FLOW-192-90	UZ-FLOW-192-20M	

Uchwyt STEP
Handle STEP
Ручка STEP

NEW

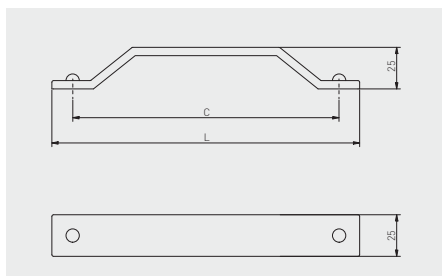

C mm	L mm				
		antyczne srebro antique silver античное серебро	czarny mat black matt чёрный матовый		ZnAl
160	185	UZ-STEP-160-07	UZ-STEP-160-20M		

Uchwyt UZ-01
Handle UZ-01
Ручка UZ-01

NEW

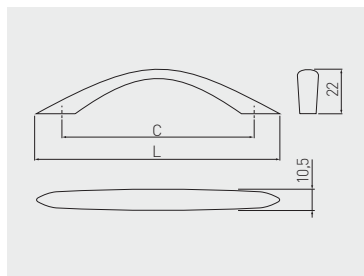

C mm	L mm				
		chrom chrome хром	satyna satin сатин	aluminium aluminium алюминий	ZnAl
96	121	UZ-01-096-01	UZ-01-096-02	UZ-01-096-05	
128	158	UZ-01-128-01	UZ-01-128-02	UZ-01-128-05	

Uchwyt UZ-05
Handle UZ-05
Ручка UZ-05

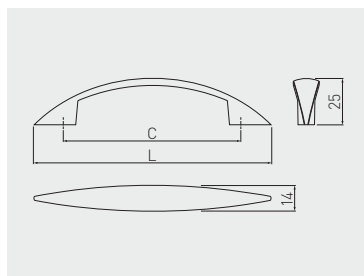

C mm	L mm				
		chrom chrome хром	satyna satin сатин	aluminium aluminium алюминий	ZnAl
96	132	UZ-05-096-01	UZ-05-096-02	UZ-05-096-05	
128	164	UZ-05-128-01	UZ-05-128-02	UZ-05-128-05	

Uchwyt UZ-06
Handle UZ-06
Ручка UZ-06

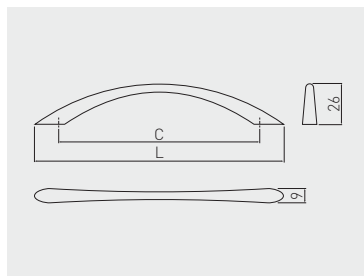

C mm	L mm				
		chrom chrome хром	satyna satin сатин	aluminium aluminium алюминий	ZnAl
128	164	UZ-06-128-01	UZ-06-128-02	UZ-06-128-05	

Uchwyt UZ-07
Handle UZ-07
Ручка UZ-07

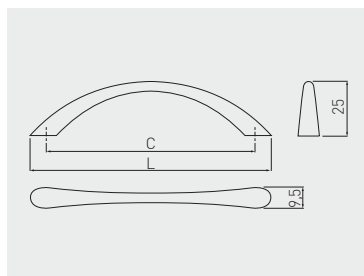



C mm	L mm				
		chrom chrome хром	satyna satin сатин	aluminium aluminium алюминий	ZnAl
96	111	UZ-07-096-01	UZ-07-096-02	UZ-07-096-05	

Uchwyt UZ-Z10
Handle UZ-Z10
Ручка UZ-Z10

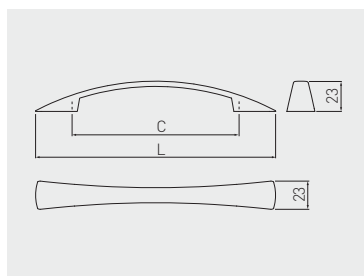
NEW



C mm	L mm					
		chrom chrome хром	satyna satin сатин	aluminium aluminium алюминий	czarny mat black matt чёрный матовый	ZnAl
96	138	UZ-Z10096-01	UZ-Z10096-02	UZ-Z10096-05	UZ-Z10096-20M	
128	184	UZ-Z10128-01	UZ-Z10128-02	UZ-Z10128-05	UZ-Z10128-20M	

Uchwyt UZ-13
Handle UZ-13
Ручка UZ-13

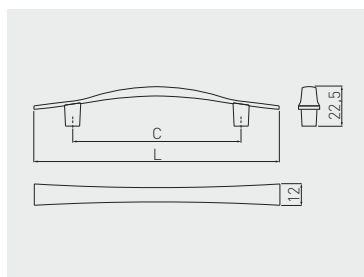

C mm	L mm					
		chrom chrome хром	satyna satin сатин	aluminium aluminium алюминий		ZnAl
96	140	UZ-13-096-01	UZ-13-096-02	UZ-13-096-05		

Uchwyt UZ-14
Handle UZ-14
Ручка UZ-14

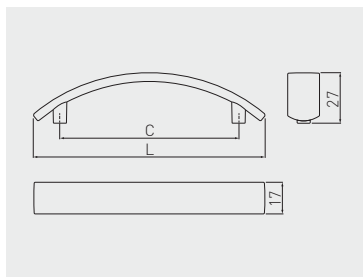

C mm	L mm				
96	138	chrom chrome хром	satyna satin сатин	aluminium aluminium алюминий	ZnAl
128	184	UZ-14-096-01	UZ-14-096-02	UZ-14-096-05	
		UZ-14-128-01	UZ-14-128-02	UZ-14-128-05	

Uchwyt CAMAIO
Handle CAMAIO
Ручка CAMAIO

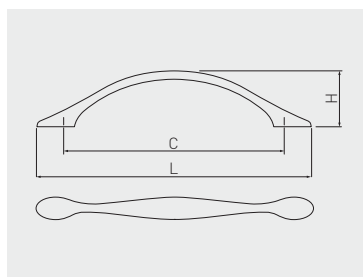

C mm	L mm	H mm				
96	126	23	chrom chrome хром	satyna satin сатин	stal szcztokowana brushed steel шлифованная сталь	antyczny miedziany szcztokowany antique brushed brass античная шлифованная латунь
128	160	32,5	UZ-CAMAI-96-01	UZ-CAMAI-96-02	UZ-CAMAI-96-06	UZ-CAMAI-96-09
			UZ-CAMAI-128-01	UZ-CAMAI-128-02	UZ-CAMAI-128-06	UZ-CAMAI-128-09

C mm	L mm	H mm				
96	126	23	biały mat white matt белый матовый	czarny mat black matt чёрный матовый	czarny chrom black chrome чёрный хром	ZnAl
128	160	32,5	UZ-CAMAI-96-10M	UZ-CAMAI-96-20M	UZ-CAMAI-96-12	
			UZ-CAMAI-128-10M	UZ-CAMAI-128-20M	UZ-CAMAI-128-12	

Gatka BERGAMO
Knob BERGAMO
Ручка BERGAMO

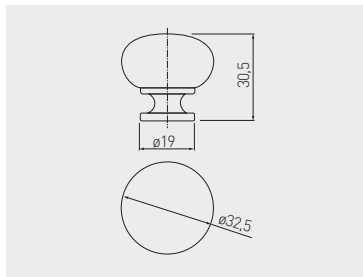

	chrom chrome хром	satyna satin сатин	aluminium aluminium алюминий	stal szczotkowana brushed steel шлифованная сталь	stal steel сталь
gatka knob ручка	GS-BERGA-1-01	GS-BERGA-1-02	GS-BERGA-1-05	GS-BERGA-1-06	



	biały white белый	czarny mat black matt чёрный матовый	czarny chrom black chrome чёрный хром	stal steel сталь
gatka knob ручка	GS-BERGA-1-10	GS-BERGA-1-20M	GS-BERGA-1-12	

Gatka UDINE
Knob UDINE
Ручка UDINE

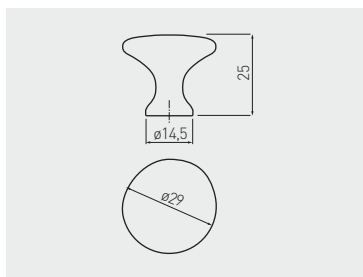

	chrom chrome хром	satyna satin сатин	aluminium aluminium алюминий	stal szczotkowana brushed steel шлифованная сталь	ZnAl
gatka knob ручка	GZ-UDINE-1-01	GZ-UDINE-1-02	GZ-UDINE-1-05	GZ-UDINE-1-06	



	biały mat white matt белый матовый	czarny chrom black chrome чёрный хром	czarny mat black matt чёрный матовый	ZnAl
gatka knob ручка	GZ-UDINE-1-10M	GZ-UDINE-1-12N	GZ-UDINE-1-20M	

Gatka TERNI
Knob TERNI
Ручка TERNI

NEW

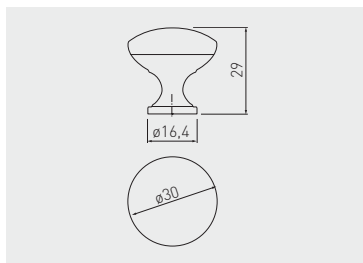

	chrom chrome хром	satyna satin сатин	aluminium aluminium алюминий	stal szcztokowana brushed steel шлифованная сталь	antyczny mosiądz szcztokowany antique brushed brass античная шлифованная латунь
gatka knob ручка	GZ-TERNI-1-01	GZ-TERNI-1-02	GZ-TERNI-1-05	GZ-TERNI-1-06	GZ-TERNI-1-09



	biały white белый	czarny chrom black chrome чёрный хром	miedź copper медь	złoty mosiądz gold brass золотая латунь	czarny mat black matt чёрный матовый	ZnAl
gatka knob ручка	GZ-TERNI-1-10	GZ-TERNI-1-12	GZ-TERNI-1-15	GZ-TERNI-1-16	GZ-TERNI-1-20M	

Gatka GZ-1155
Knob GZ-1155
Ручка GZ-1155

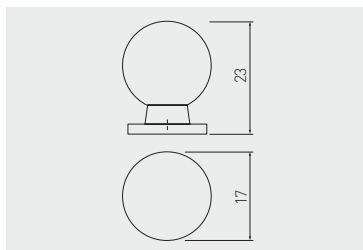

	chrom chrome хром	ZnAl
gatka knob ручка	GZ-WP1155-01	

Gatka GZ-ZH
Knob GZ-ZH
Ручка GZ-ZH

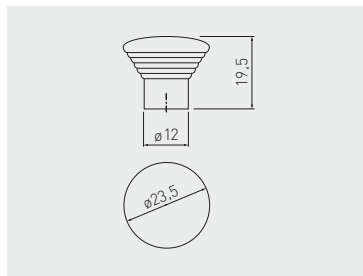

			
	chrom chrome хром	aluminium aluminium алюминий	ZnAl
gatka knob ручка	GZ-ZH-011-01A	GZ-ZH-011-05A	

Uchwyt TRIEST
Handle TRIEST
Ручка TRIEST

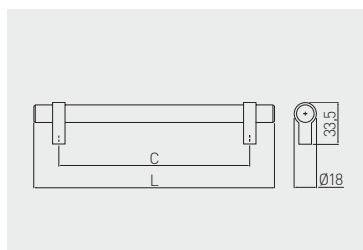

			
		stal szczotkowana brushed steel шлифованная сталь	
96	136	RS-TRIES-96-06	stal, ZnAl steel, ZnAl сталь, ZnAl
128	168	RS-TRIES-128-06	
160	200	RS-TRIES-160-06	
192	232	RS-TRIES-192-06	
256	296	RS-TRIES-256-06	
320	360	RS-TRIES-320-06	

Uchwyt RELING RS

Handle RELING RS

Ручка RELING RS

RAIL

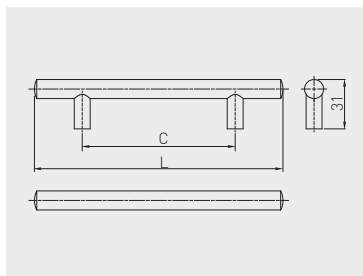

C mm	L mm	chrom chrome хром	satyna satin сатин	aluminium aluminium алюминий	stal szczotkowana brushed steel шлифованная сталь	antyczna miedź antique copper античная медь	
96	156	RS-156096-01	RS-156096-02	RS-156096-05	RS-156096-06	RS-156096-14	stal steel сталь
128	188	RS-188128-01	RS-188128-02	RS-188128-05	RS-188128-06	RS-188128-14	
160	220	RS-220160-01	RS-220160-02	RS-220160-05	RS-220160-06	RS-220160-14	
192	272	RS-272192-01	RS-272192-02	RS-272192-05	RS-272192-06	RS-272192-14	
224	304	RS-304224-01	RS-304224-02	RS-304224-05	RS-304224-06	RS-304224-14	
256	336	RS-336256-01	RS-336256-02	RS-336256-05	RS-336256-06	RS-336256-14	
288	368	RS-368288-01	RS-368288-02	RS-368288-05	RS-368288-06	RS-368288-14*	
320	400	RS-400320-01	RS-400320-02	RS-400320-05	RS-400320-06	RS-400320-14	
448	528	RS-528448-01	RS-528448-02*	RS-528448-05	RS-528448-06*	RS-528448-14*	

C mm	L mm	stal szczotkowana brushed steel шлифованная сталь	czarny mat black matt чёрный матовый	
96	156	-	ID-RS-E-15696-20M*	stal steel сталь
128	188	-	ID-RS-E-188128-20M*	
160	220	ID-RS-E-220160-06*	ID-RS-E-220160-20M*	
192	272	ID-RS-E-272192-06*	ID-RS-E-272192-20M*	
224	304	ID-RS-E-304224-06*	ID-RS-E-304224-20M*	
256	336	ID-RS-E-336256-06*	ID-RS-E-336256-20M*	
288	368	ID-RS-E-368288-06*	ID-RS-E-368288-20M*	
320	400	ID-RS-E-400320-06*	ID-RS-E-400320-20M*	

Na indywidualne zamówienie dostępne również rozstawy:
352, 384, 416, 480, 512, 544, 576, 608, 640, 672, 704, 736,
768, 800 [mm].

Other sizes are available for special orders:
352, 384, 416, 480, 512, 544, 576, 608, 640, 672, 704, 736,
768, 800 [mm].

Pod заказ доступны ручки с межцентровым расстоянием:
352, 384, 416, 480, 512, 544, 576, 608, 640, 672, 704, 736,
768, 800 [mm]

antyczna miedź
antique copper
античная медь







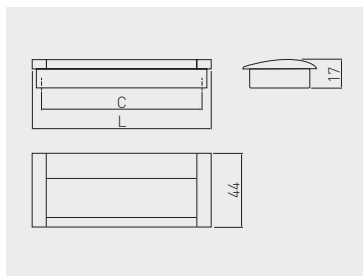

* Produkt dostępny na indywidualne zamówienie / Available for special orders / Товар доступен под заказ

Istnieje możliwość zakupu dodatkowych rozstawów i kolorów na zamówienie indywidualne / Additional spacings and colours can be purchased on individual order / По индивидуальному заказу можно приобрести дополнительные размеры и цвета









Uchwyt UA-326
Handle UA-326
Ручка UA-326

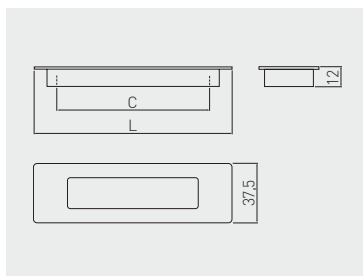

 C mm	 L mm			
		aluminium / chrom aluminium / chrome алюминий / хром	czarny black чёрный	aluminium aluminium алюминий
96	108	UA-01-326096-V1	UA-00-326096-20M	
128	140	UA-01-326128-V1	UA-00-326128-20M	
160	172	UA-01-326160	UA-00-326160-20M	

Uchwyt UZ-E6
Handle UZ-E6
Ручка UZ-E6



 C mm	 L mm				
		chrom chrome хром	aluminium aluminium алюминий	stal szcztokowana brushed steel шлифованная сталь	ZnAl
96	124	UZ-E6-096-01	UZ-E6-096-05	UZ-E6-096-06	
128	155	UZ-E6-128-01	UZ-E6-128-05	UZ-E6-128-06	
160	186	UZ-E6-160-01	UZ-E6-160-05	UZ-E6-160-06	

Uchwyt B224
Handle B224
Ручка B224

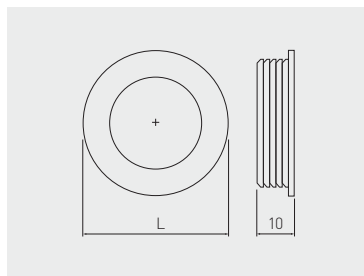

 L mm						
	chrom chrome хром	satyna satin сатин	aluminium aluminium алюминий	biały white белый	czarny black чёрный	ZnAl
40,5	UZ-00B224-01	UZ-00B224-02	UZ-00B224-05	UZ-00B224-10	UZ-00B224-20	

Uchwyt B226
Handle B226
Ручка B226

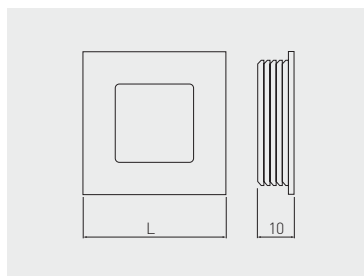



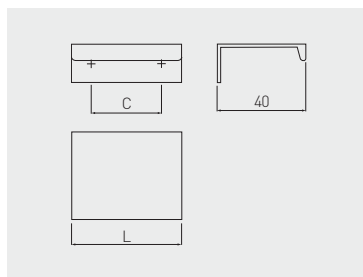

 L mm						
	chrom chrome хром	satyna satin сатин	aluminium aluminium алюминий	biały white белый	czarny black чёрный	ZnAl
40	UZ-00B226-01	UZ-00B226-02	UZ-00B226-05	UZ-00B226-10	UZ-00B226-20	

Uchwyt HEXI
Handle HEXI
Ручка HEXI

NEW



 C mm	 L mm					
		chrom chrome хром	aluminium aluminium алюминий	biały mat white matt белый матовый	czarny mat black matt чёрный матовый	aluminium aluminium алюминий
32	50	UA-HEXI-01	UA-HEXI-05	UA-HEXI-10M	UA-HEXI-20M	
96	150	UA-HEXI96-01	UA-HEXI96-05	UA-HEXI96-10M	UA-HEXI96-20M	
192	225	UA-HEXI192-01	UA-HEXI192-05	UA-HEXI192-10M	UA-HEXI192-20M	
do cięcia to cut для резки	3500	-	UA-HEXI-3500-05	-	UA-HEXI-3500-20M	

 C mm	 L mm				
		antracyt anthracite антрацит	złoty szczotkowany brushed gold матовое золото		aluminium aluminium алюминий
32	50	UA-HEXI-60	UA-HEXI-18		
96	150	UA-HEXI96-60	UA-HEXI96-18		
192	225	UA-HEXI192-60	UA-HEXI192-18		

Uchwyt PAXO
Handle PAXO
Ручка PAXO

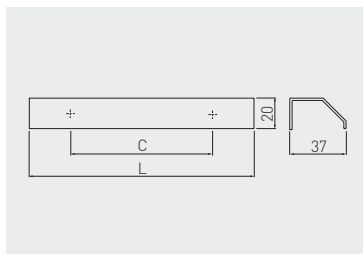

 C mm	 L mm		
		aluminium aluminium алюминий	
32	50	UA-PAXO-32-50-05	aluminium aluminium алюминий
96	150	UA-PAXO-96-150-05	
224	250	UA-PAXO-224-250-05	
320	350	UA-PAXO-320-350-05	
do cięcia to cut для резки	3500	UA-PAXO-3500-05	

Uchwyt TREX
Handle TREX
Ручка TREX

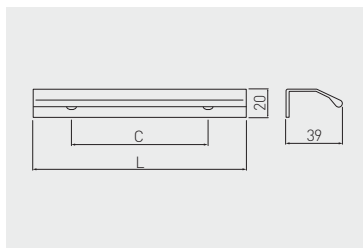

NEW

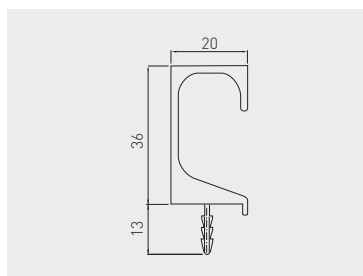

 C mm	 L mm		
		aluminium aluminium алюминий	czarny mat black matt чёрный матовый
32	50	UA-TREX-32-50-05	UA-TREX-32-50-20M
96	150	UA-TREX-96-150-05	UA-TREX-96-150-20M
224	250	UA-TREX-224-250-05	UA-TREX-224-250-20M
320	350	UA-TREX-320-350-05	UA-TREX-320-350-20M
do cięcia to cut для резки	3500	UA-TREX-3500-05	UA-TREX-3500-20M

Uchwyt PROFIL C
Handle PROFIL C
Ручка PROFIL C



 C mm	 L mm				
do cięcia to cut для резки	3500	aluminium aluminium алюминий	stal szcztokowana brushed steel шлифованная сталь	czarny mat black matt чёрный матовый	aluminium aluminium алюминий
		PA-0242-35-50	PA-0242-35-50-06	PA-0242-35-50-20M	



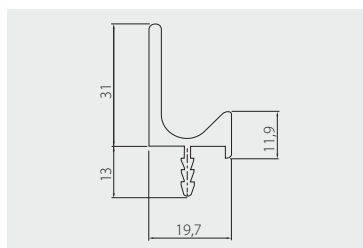

Uchwyt PROFIL L
Handle PROFIL L
Ручка PROFIL L

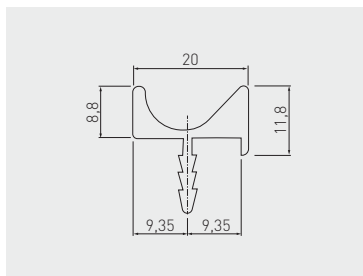

 C mm	 L mm				
do cięcia to cut для резки	3500	aluminium aluminium алюминий	stal szcztokowana brushed steel шлифованная сталь	czarny mat black matt чёрный матовый	aluminium aluminium алюминий
		PA-0243-35-50	PA-0243-35-50-06	PA-0243-35-50-20M	





Uchwyt PROFIL U
Handle PROFIL U
Ручка PROFIL U

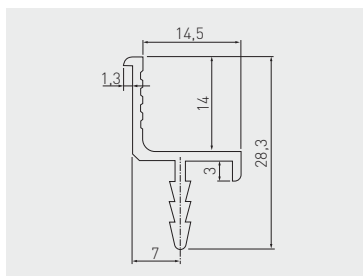

 C mm	 L mm		
do cięcia to cut для резки	3500	aluminium aluminium алюминий	aluminium aluminium алюминий
		PA-0244-35-50	

Uchwyt PROFIL J
Handle PROFIL J
Ручка PROFIL J



 C mm	 L mm		
do cięcia to cut для резки	3500	aluminium aluminium алюминий	aluminium aluminium алюминий
		PA-0245-35-50	

Uchwyt PROFIL C2
Handle PROFIL C2
Ручка PROFIL C2

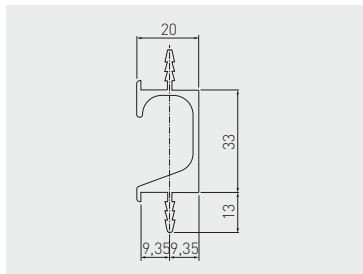



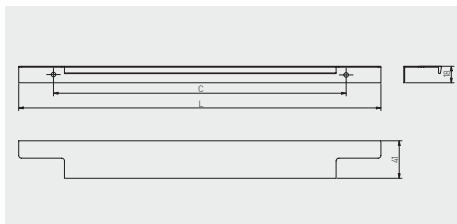

 C mm	 L mm		
		aluminium aluminium алюминий	
do cięcia to cut для резки	3500	PA-0241-35-50	aluminium aluminium алюминий

Uchwyt LIND
Handle LIND
Ручка LIND

NEW



 C mm	 L mm					
		chrom chrome хром	aluminium aluminium алюминий	złoty szczotkowany brushed gold матовое золото	czarny mat black matt чёрный матовый	aluminium aluminium алюминий
256	296	UA-LIND-256-296-01	UA-LIND-256-296-05	UA-LIND-256-296-18	UA-LIND-256-296-20M	
320	396	UA-LIND-320-396-01	UA-LIND-320-396-05	UA-LIND-320-396-18	UA-LIND-320-396-20M	
224	496*	UA-LIND-224-496-01	UA-LIND-224-496-05	UA-LIND-224-496-18	UA-LIND-224-496-20M	
256	596	UA-LIND-256-596-01	UA-LIND-256-596-05	UA-LIND-256-596-18	UA-LIND-256-596-20M	
352	796	UA-LIND-352-796-01	UA-LIND-352-796-05	UA-LIND-352-796-18	UA-LIND-352-796-20M	

* Mocowanie na 3 wkręty / Mounted with 3 screws / Крепление на 3 самореза

Uchwyt PICADO
Handle PICADO
Ручка PICADO

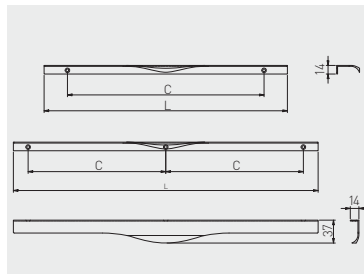

C
mm

L
mm



		chrom chrome хром	aluminium aluminium алюминий	czarny mat black matt чёрный матовый	
256	296	UA-PICADO-256-296-01	UA-PICADO-256-296-05	UA-PICADO-256-296-20M	aluminium aluminium алюминий
320	396	UA-PICADO-320-396-01	UA-PICADO-320-396-05	UA-PICADO-320-396-20M	
2 x 224*	496	UA-PICADO-224-496-01	UA-PICADO-224-496-05	UA-PICADO-224-496-20M	
2 x 256*	596	UA-PICADO-256-596-01	UA-PICADO-256-596-05	UA-PICADO-256-596-20M	
2 x 352*	796	UA-PICADO-352-796-01	UA-PICADO-352-796-05	UA-PICADO-352-796-20M	

* Mocowanie na 3 wkręty / Mounted with 3 screws / Крепление на 3 самореза



System bezuchwytowy VELLO
VELLO handleless system
Безрукоятковая система VELLO

NEW

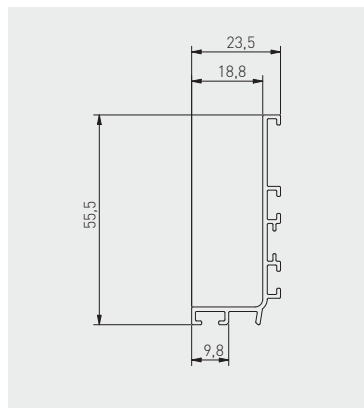

C mm	L mm					
		aluminium aluminium алюминий	stal szcztokowana brushed steel шлифованная сталь	biały white белый	czarny mat black matt чёрный матовый	aluminium aluminium алюминий
do cięcia to cut для резки	3000	PA-VELLO-L3M-05	PA-VELLO-L3M-06	PA-VELLO-L3M-10	PA-VELLO-L3M-20M	

Akcesoria / Accessories / Аксессуары



PA-ZASVELLO-LNL-20M



PA-ZASVELLO-LNP-20M



PA-ZASVELLO-LPL-20M



PA-ZASVELLO-LPP-20M



PA-OSMLGLAXMIC3M-00N

Ostonki / Covers / Крышки

aluminium aluminium алюминий	stal szcztokowana brushed steel шлифованная сталь	biały white белый	czarny mat black matt чёрный матовый	tworzywo plastic пластмасса	
PA-ZASVELLO-LNL-05	PA-ZASVELLO-LNL-06	PA-ZASVELLO-LNL-10	PA-ZASVELLO-LNL-20M		
PA-ZASVELLO-LNP-05	PA-ZASVELLO-LNP-06	PA-ZASVELLO-LNP-10	PA-ZASVELLO-LNP-20M		
PA-ZASVELLO-LPL-05	PA-ZASVELLO-LPL-06	PA-ZASVELLO-LPL-10	PA-ZASVELLO-LPL-20M		
PA-ZASVELLO-LPP-05	PA-ZASVELLO-LPP-06	PA-ZASVELLO-LPP-10	PA-ZASVELLO-LPP-20M		



PA-MOUNT-GL-00

Możliwość zastosowania oświetlenia LED. Polecana ostonka PA-OSMLGLAXMIC3M-00N
Possibility of using LED lighting. Recommended PA-OSMLGLAXMIC3M-00N cover.
Возможность использования светодиодного освещения. Рекомендуемая заглушка PA-OSMLGLAXMIC3M-00N



GTV

System bezuchwytowy VELLO
VELLO handleless system
Безрукоятковая система VELLO

NEW

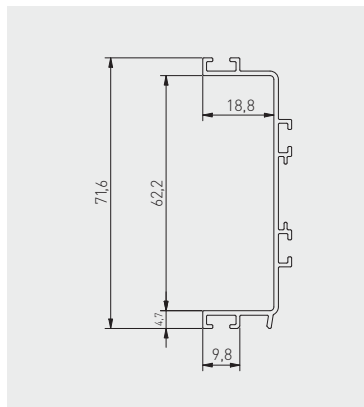

	C mm	L mm					
			aluminium aluminium алюминий	stal szczotkowana brushed steel шлифованная сталь	biały white белый	czarny mat black matt чёрный матовый	aluminium aluminium алюминий
do cięcia to cut для резки		3000	PA-VELLO-C3M-05	PA-VELLO-C3M-06	PA-VELLO-C3M-10	PA-VELLO-C3M-20M	

Akcesoria / Accessories / Аксессуары



PA-ZASVELLO-CN-20M



PA-ZASVELO-CP-20M



PA-MOUNT-GL-00

Ostonki / Covers / Крышки



PA-OSMLGLAXMIC3M-00N

	aluminium aluminium алюминий	stal szczotkowana brushed steel шлифованная сталь	biały white белый	czarny mat black matt чёрный матовый	tworzywo plastic пластмасса
		PA-ZASVELLO-CN-06	PA-ZASVELLO-CN-10	PA-ZASVELLO-CN-20M	
PA-ZASVELLO-CP-05	PA-ZASVELLO-CP-06	PA-ZASVELO-CP-10	PA-ZASVELO-CP-20M		

Możliwość zastosowania oświetlenia LED. Polecana ostonka PA-OSMLGLAXMIC3M-00N

Possibility of using LED lighting. Recommended PA-OSMLGLAXMIC3M-00N cover.



Возможность использования светодиодного освещения. Рекомендуемая заглушка PA-OSMLGLAXMIC3M-00N

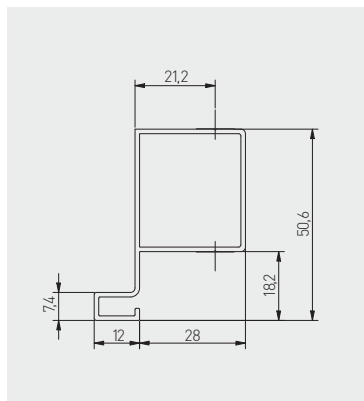

System bezuchwytowy VELLO
 VELLO handleless system
 Безрукоятковая система VELLO

NEW





 C mm	 L mm					
		aluminium aluminium алюминий	stal szcztokowana brushed steel шлифованная сталь	biały white белый	czarny mat black matt чёрный матовый	aluminium aluminium алюминий
do cięcia to cut для резки	3000	PA-VELLO-TJ3M-05	PA-VELLO-TJ3M-06	PA-VELLO-TJ3M-10	PA-VELLO-TJ3M-20M	

System bezuchwytowy VELLO
 VELLO handleless system
 Безрукоятковая система VELLO

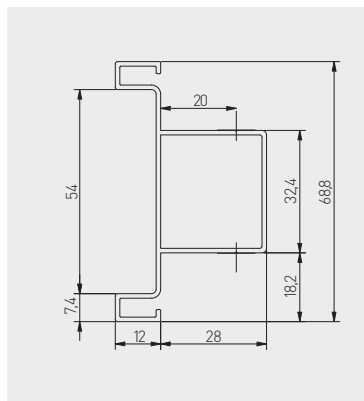
NEW



	 C mm	 L mm					
			aluminium aluminium алюминий	stal szcztokowana brushed steel шлифованная сталь	biały white белый	czarny mat black matt чёрный матовый	aluminium aluminium алюминий
do cięcia to cut для резки	3000	PA-VELLO-TD3M-05	PA-VELLO-TD3M-06	PA-VELLO-TD3M-10	PA-VELLO-TD3M-20M		

Gatka J4
Knob J4
Ручка J4

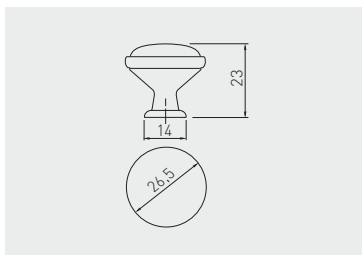

motyw pattern рисунок	antyczny mosiądz antique brass античная латунь	antyczne srebro antique silver старинное серебро	
autumn rose	GP-0728-J4-B	-	ZnAl, porcelana ZnAl, porcelain ZnAl, фарфор
spring flower	GP-0728-J4-R	-	
blue rose	GP-0728-J4-A-04	GP-0728-J4-A-07	
orient gold	GP-0728-J4-C-04	-	



autumn rose



spring flower



blue rose



orient gold

Uchwyt 728B
Handle 728B
Ручка 728B

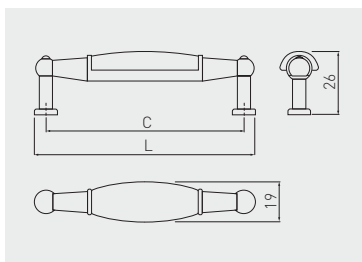

motyw pattern рисунок	C mm	L mm	antyczny mosiądz antique brass античная латунь	
spring flower	96	106	UP-WP0728-BR	ZnAl, porcelana ZnAl, porcelain ZnAl, фарфор
country	96	106	UP-WP0728-BK	
ornament	96	106	UP-WP0728-BX	
autumn rose	96	106	UP-WP0728-BB	



spring flower



country



ornament



autumn rose

Uchwyt 728P
Handle 728P
Ручка 728P

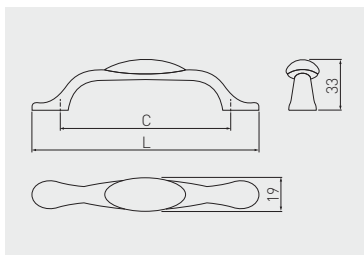

motyw pattern рисунок	C mm	L mm	antyczny mosiądz antique brass античная латунь	antyczne srebro antique silver старинное серебро	ZnAl, porcelana ZnAl, porcelain ZnAl, фарфор
blue rose	96	125	UP-WP0728-PA-04	UP-WP0728-PA-07	
orient gold	96	125	UP-WP0728-PC-04	-	
ornament	96	125	UP-WP0728-PX	-	
autumn rose	96	125	UP-WP0728-PB	-	
spring flower	96	125	UP-WP0728-PR	-	
country	96	125	UP-WP0728-PK	-	
milky	96	125	UP-WP0728-P0	-	



blue rose

orient gold

ornament

autumn rose

spring flower

country

milky

Uchwyt ALATRI
Handle ALATRI
Ручка ALATRI

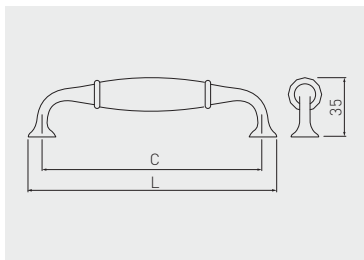

C mm	L mm	antyczny mosiądz antique brass античная латунь	ZnAl, porcelana ZnAl, porcelain ZnAl, фарфор
128	144	UZ-ALATR-128-04	



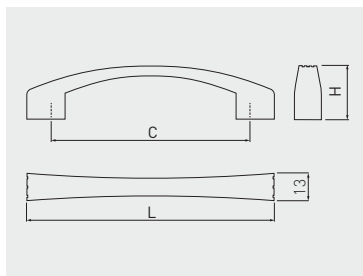



Uchwyt VASTO
Handle VASTO
Ручка VASTO

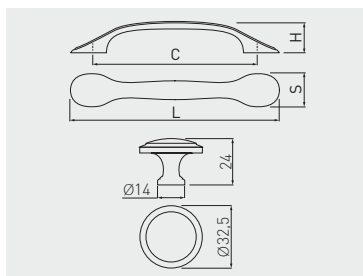

 C mm	 L mm	 H mm		
			antyczny mosiądz szczotkowany antique brushed brass античная шлифованная латунь	ZnAl
96	120	26	UZ-VASTO-96-09	
128	151	27	UZ-VASTO-128-09	





Uchwyt PALERMO
Handle PALERMO
Ручка PALERMO

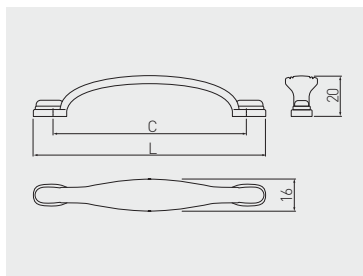

 C mm	 L mm	 H mm	 S mm		
				antyczne srebro antique silver античное серебро	ZnAl
96	127	22,5	23	UZ-PALER-96-07	
128	159	23	25	UZ-PALER-128-07	
gatka knob ручка	-	-	-	GZ-PALER-1-07	

Uchwyt UZ-10
Handle UZ-10
Ручка UZ-10



 C mm	 L mm		
		antyczny miedziadź antique brass античная латунь	ZnAl
96	120	UZ-10-096-N04	

Uchwyt UZ-12
Handle UZ-12
Ручка UZ-12

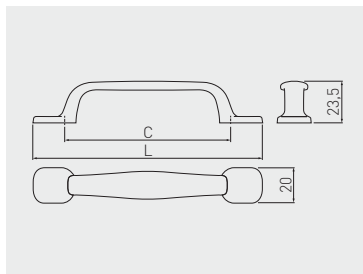

 C mm	 L mm				
		antyczny miedziadź antique brass античная латунь	antyczne srebro antique silver античное серебро	czarny mat black matt чёрный матовый	ZnAl
96	131	UZ-12-096-04N	UZ-12-096-07	UZ-12-096-20M	

Uchwyt RETRIS
Handle RETRIS
Ручка RETRIS

NEW

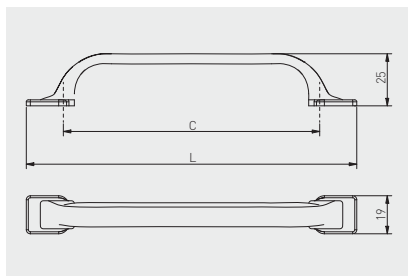

C mm	L mm				
128	165	antyczny mosiądz antique brass античная латунь	antyczne srebro antique silver античное серебро	czarny mat black matt чёрный матовый	ZnAl
		UZ-RETRIS-128-04	UZ-RETRIS-128-07	UZ-RETRIS-128-20M	

Gatka ARDEA
Knob ARDEA
Ручка ARDEA

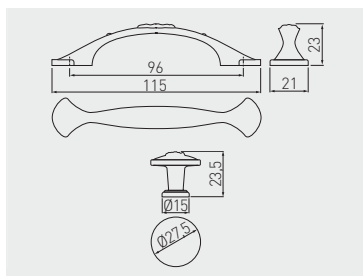

C mm	L mm		
96	115	antyczny mosiądz antique brass античная латунь	ZnAl
gatka knob ручка	-	GZ-ARDEA-1-09	



Uchwyt WERONA
Handle WERONA
Ручка WERONA

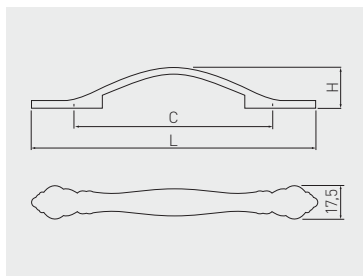

C mm	L mm	H mm				
96	148	24,5	antyczny mosiądz antique brass античная латунь	antyczny mosiądz szczotkowany antique brushed brass античная шлифованная латунь	czarny chrom black chrome чёрный хром	ZnAl
128	183	26,5	UZ-WERON-96-04	UZ-WERON-96-09	UZ-WERON-96-12	
			UZ-WERON-128-04	UZ-WERON-128-09	UZ-WERON-128-12	

Uchwyt ARCHE*
Handle ARCHE*
Ручка ARCHE*

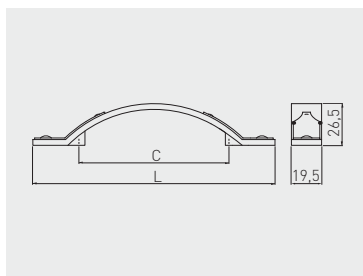

C mm	L mm		
96	155	antyczny mosiądz szczotkowany antique brushed brass античная шлифованная латунь	ZnAl
		UZ-ARCH096-AEB	

* Produkt dostępny na indywidualne zamówienie / Available for special orders / Товар доступен под заказ

Uchwyt AREZO
Handle AREZO
Ручка AREZO

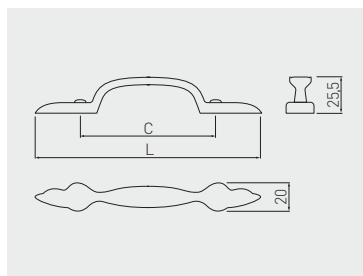

C mm	L mm		
96	160	antyczny mosiądz antique brass античная латунь	ZnAl
		UZ-AREZO-96-04	

Uchwyt ABIATE
Handle ABIATE
Ручка ABIATE

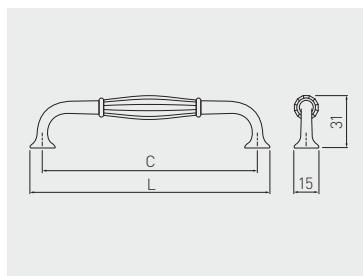

C mm	L mm		
128	143	antyczny mosiądz antique brass античная латунь	ZnAl
		UZ-ABIAT-128-04	

Uchwyt ADRIN
Handle ADRIN
Ручка ADRIN

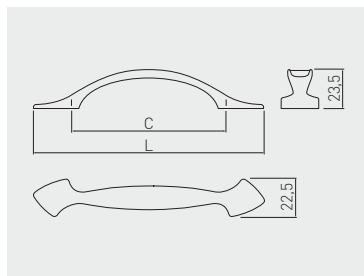

C mm	L mm		
96	139	antyczny mosiądz antique brass античная латунь	ZnAl
UZ-ADRIN-96-04			

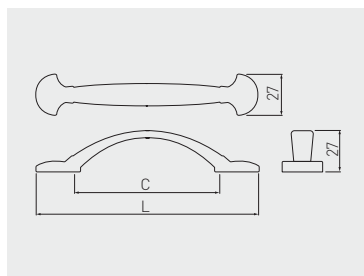

Uchwyt ACERA
Handle ACERA
Ручка ACERA



C mm	L mm		
96	147	antyczny mosiądz antique brass античная латунь	ZnAl
UZ-ACERA-96-04			

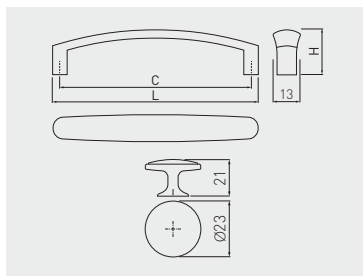



Uchwyt OLBIA
Handle OLBIA
Ручка OLBIA

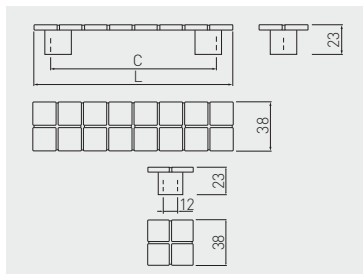

 C mm	 L mm	 H mm		
			antyczny mosiądz antique brass античная латунь	ZnAl
96	103	22	UZ-OLBIA-96-04	
128	136	24	UZ-OLBIA-128-04	
gatka knob ручка	-	-	GZ-OLBIA-1-04	

Uchwyt AZTEK
Handle AZTEK
Ручка AZTEK



 C mm	 L mm		
		antyczny mosiądz antique brass античная латунь	ZnAl
128	155	UZ-AZ-128-04	
gatka knob ручка	38	UZ-AZ-012-04	

Uchwyt MARSALA
Handle MARSALA
Ручка MARSALA

NEW

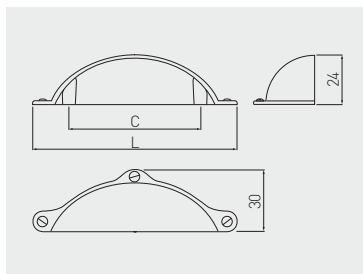

C mm	L mm					
64	99,5	antyczne srebro antique silver античное серебро	antyczny miedź antique brushed brass античная шлифованная латунь	biały mat white matt белый матовый	ZnAl	
		UZ-MARSA-64-07	UZ-MARSA-64-09	UZ-MARSA-64-10M		
C mm	L mm					
64	99,5	tytan szczotkowany brushed titanium шлифованный титан	miedź copper медь	złoty szczotkowany brushed gold матовое золото	czarny mat black matt чёрный матовый	ZnAl
		UZ-MARSA-64-11	UZ-MARSA-64-15	UZ-MARSA-64-18	UZ-MARSA-64-20M	



Uchwyt ROYAL
Handle ROYAL
Ручка ROYAL

GZ-ROYAL3-1-10-03

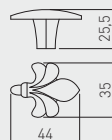

UZ-ROYAL4-96-03

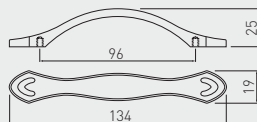

UZ-ROYAL1-96-10-03

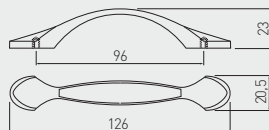

UZ-ROYAL2-96-10-03

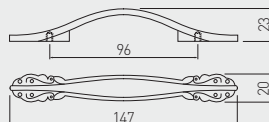



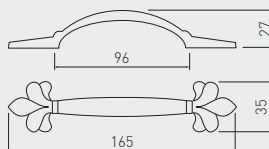

UZ-ROYAL3-96-10-03

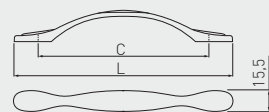

UZ-ROYAL5-128-10-03



	 C mm	 L mm		
motyw pattern рисунок			biały, złoty white, gold белый, золото	ZnAl
latina	96	126	UZ-ROYAL1-96-10-03	
werona	96	147	UZ-ROYAL2-96-10-03	
genova	96	165	UZ-ROYAL3-96-10-03	
reggio	96	134	UZ-ROYAL4-96-03	
piano	96	131	UZ-ROYAL5-96-10-03	
	128	164	UZ-ROYAL5-128-10-03	
genova	galka knob ручка	35	GZ-ROYAL3-1-10-03	

Gatka UZ-WP146
Knob UZ-WP146
Ручка UZ-WP146

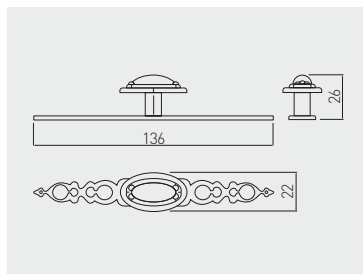

		
	antyczny mosiądz antique brass античная латунь	ZnAl
gatka knob ручка	UZ-WP1146-04	

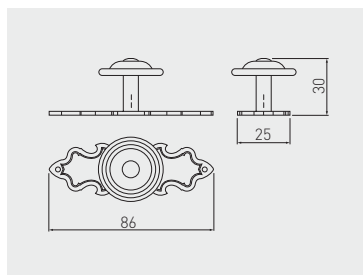

Gatka GZ-1136
Knob GZ-1136
Ручка GZ-1136

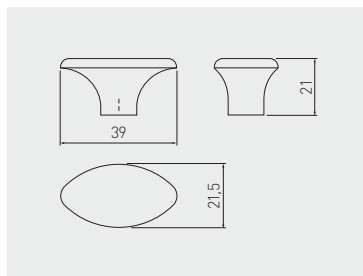

		
	antyczny mosiądz antique brass античная латунь	ZnAl
gatka knob ручка	GZ-WP1136-04	

Gatka GZ-1148
 Knob GZ-1148
 Ручка GZ-1148



		
	antyczny mosiądz antique brass античная латунь	ZnAl
gatka knob ручка	GZ-WP1148-04	

Gatka GZ-1152*
 Knob GZ-1152*
 Ручка GZ-1152*

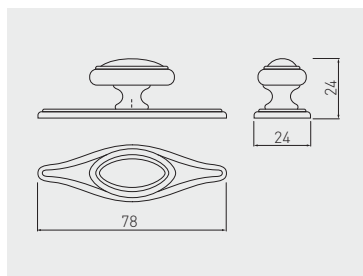

		
	antyczny mosiądz antique brass античная латунь	ZnAl
gatka knob ручка	GZ-WP1152-04	

* Produkt dostępny na indywidualne zamówienie / Available for special orders / Товар доступен под заказ

Uchwyt RENNES
Handle RENNES
Ручка RENNES

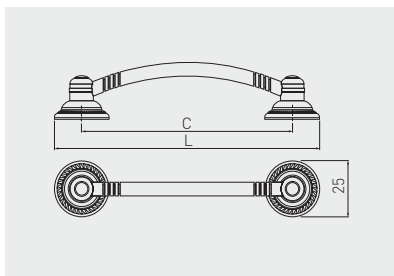

C mm	L mm		
96	121	antyczny mosiądz antique brass античная латунь	ZnAl
		UZ-REN096-04A	

Kołatka KT-1147
Knocker KT-1147
Ручка KT-1147

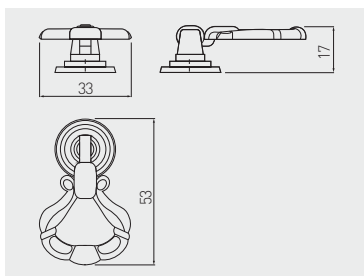

		
kołatka knocker ручка	antyczny mosiądz antique brass античная латунь	ZnAl
	KT-WP1147-04	

Gatka CENTO
 Knob CENTO
 Ручка CENTO

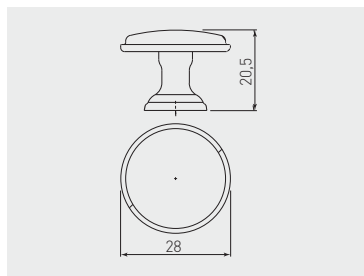

	antyczny mosiądz antique brass античная латунь	antyczne srebro antique silver античное серебро	antyczna miedź antique copper античная медь	czarny mat black matt чёрный матовый	ZnAl
gatka knob ручка	GZ-CENTO-1-04	GZ-CENTO-1-07	GZ-CENTO-1-14	GZ-CENTO-1-20M	



Gatka IMPERIA
Knob IMPERIA
Ручка IMPERIA

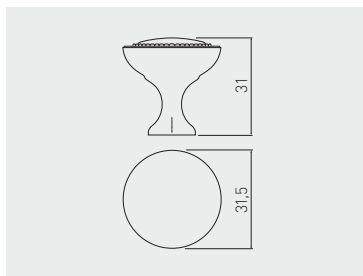

	satyna satin сатин	tytan szczotkowany brushed titanium шлифованный титан	czarny mat black matt чёрный матовый	aluminium aluminium алюминий
gatka knob ручка	GA-IMPER-1-02B	GA-IMPER-1-11	GA-IMPER-1-20M	



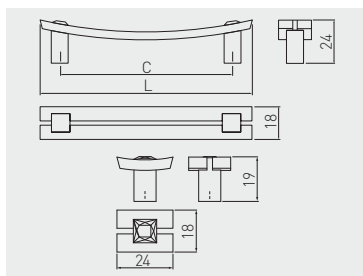

Uchwyt UZ-71C
Handle UZ-71C
Ручка UZ-71C

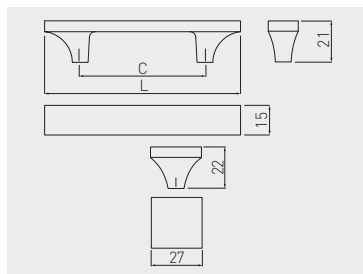

C mm	L mm		
96	118	chrom chrome хром	ZnAl, szkło ZnAl, glass ZnAl, стекло
gatka knob ручка		UZ-71C096-01 GZ-71C024-01	





Uchwyt UZ-02C
Handle UZ-02C
Ручка UZ-02C

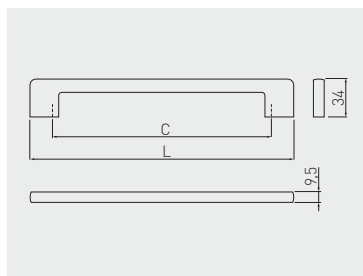

 C mm	 L mm		
		chrom chrome хром	
64	99	UZ-02C064-01	ZnAl, szkło ZnAl, glass ZnAl, стекло
96	135	UZ-02C096-01	
gatka knob ручка	27	UZ-02CF27-01	

Uchwyt UZ-CRA14*
Handle UZ-CRA14*
Ручка UZ-CRA14*





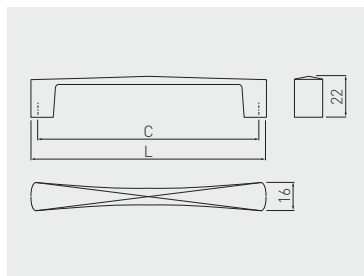

 C mm	 L mm		
		chrom chrome хром	
128	166	UZ-CRA14-128	ZnAl
192	230	UZ-CRA14-192	
320	358	UZ-CRA14-320	

* Produkt dostępny na indywidualne zamówienie / Available for special orders / Товар доступен под заказ







Uchwyt COMO
Handle COMO
Ручка COMO

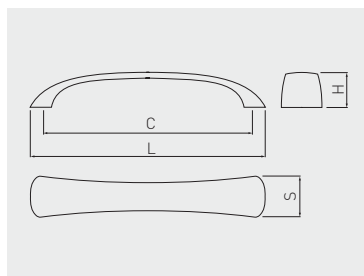

 C mm	 L mm		
		chrom chrome хром	ZnAl
96	104	UZ-COM0096-01	
128	135	UZ-COM0128-01	
160	170	UZ-COM0160-01	





Uchwyt SIENNA
Handle SIENNA
Ручка SIENNA

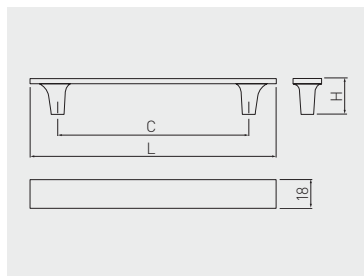

 C mm	 L mm	 H mm	 S mm		
				chrom chrome хром	ZnAl
96	111	21	23,5	UZ-SIENNA096-01	
128	142	23	25	UZ-SIENNA128-01	
160	186	24,5	26,5	UZ-SIENNA160-01	





Uchwyt LUCCA
Handle LUCCA
Ручка LUCCA

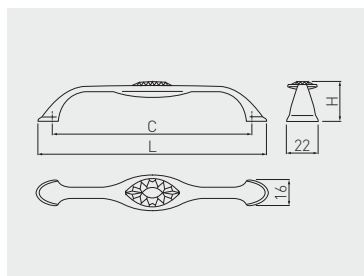

 C mm	 L mm	 H mm		
			chrom chrome хром	ZnAl
128	163	23	UZ-LUCCA128-01	
160	196	23	UZ-LUCCA160-01	
192	228	23,5	UZ-LUCCA192-01	
224	260	23,5	UZ-LUCCA224-01	

Uchwyt BIANCA
Handle BIANCA
Ручка BIANCA



 C mm	 L mm	 H mm		
			chrom chrome хром	ZnAl
96	114	25	UZ-BIANC-96-01	
128	146	26	UZ-BIANC-128-01	

* Produkt dostępny na indywidualne zamówienie / Available for special orders / Товар доступен под заказ

Gatka GZ-CRPA
Knob GZ-CRPA
Ручка GZ-CRPA

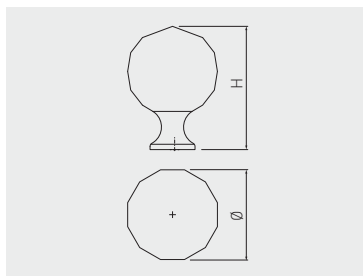

		chrom, biały kryształ chrome, white crystal хром, белый кристалл	chrom, czarny kryształ chrome, black crystal хром, чёрный кристалл	mosiądz, biały kryształ brass, white crystal латунь, белый кристалл	
20	33	GZ-CRPA20-01	-	-	ZnAl, szkło ZnAl, glass ZnAl, стекло
25	37	GZ-CRPA25-01	-	-	
30	44	GZ-CRPA30-01	GZ-CRPA30-A1	GZ-CRPA30-03	
40	55	GZ-CRPA40-01	-		

Gatka GZ-CRPB
Knob GZ-CRPB
Ручка GZ-CRPB

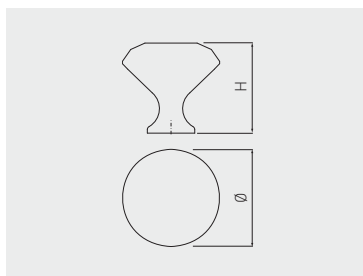

		chrom, biały kryształ chrome, white crystal хром, белый кристалл	chrom, czarny kryształ chrome, black crystal хром, чёрный кристалл	mosiądz, biały kryształ brass, white crystal латунь, белый кристалл	
20	26	GZ-CRPB20-01	-	-	ZnAl, szkło ZnAl, glass ZnAl, стекло
25	28	GZ-CRPB25-01	GZ-CRPB25-A1	-	
30	30	GZ-CRPB30-01	GZ-CRPB30-A1	GZ-CRPB30-03	
40	38	GZ-CRPB40-01	GZ-CRPB40-A1	-	

Gatka GZ-CRPC
 Knob GZ-CRPC
 Ручка GZ-CRPC

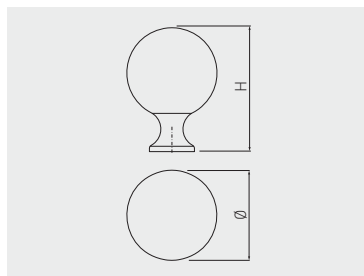

 mm	 mm		
		chrom, biały kryształ chrome, black crystal хром, белый кристалл	chrom, czarny kryształ chrome, black crystal хром, чёрный кристалл
30	43	GZ-CRPC30-01	GZ-CRPC30-A1
		ZnAl, szkło ZnAl, glass ZnAl, стекло	



Uchwył KID
Handle KID
Ручка KID



BLOCK



CLOUD



STAR



BUTTON



FLAMING



HEART



CROWN



TWITT

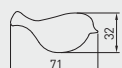
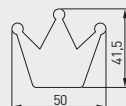
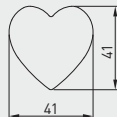
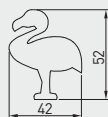
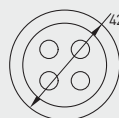
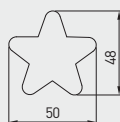
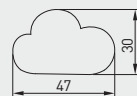
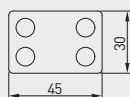

	zielony green зеленый	niebieski blue синий	czerwony red красный	szary grey серый	żółty yellow желтый	różowy pink розовый	
block	UM-BLOCK-ZL	UM-BLOCK-NB	UM-BLOCK-CZ	-	-	-	guma, ZnAl rubber, ZnAl резина, ZnAl
cloud	-	UM-CLOUD-NB	-	UM-CLOUD-SZ	-	-	
star	-	UM-STAR-NB	-	-	UM-STAR-ZT	UM-STAR-RZ	
button	-	UM-BUTTON-NB	-	UM-BUTTON-SZ	-	-	
flaming	-	-	-	UM-FLAMING-SZ	-	UM-FLAMING-RZ	
heart	-	-	-	-	-	UM-HEART-RZ	
crown	-	-	-	-	-	UM-CROWN-RZ	
twitt	UM-TWITT-ZL	-	-	UM-TWITT-SZ	-	-	



Uchwyt KID WILD
Handle KID WILD
Ручка KID WILD



UM-KID-I-002



UM-KID-P-001



UM-KID-Q-001



UM-KID-U-001

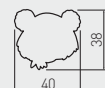
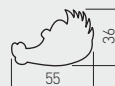

tygrys / tiger / тигр	UM-KID-I-002	guma, ZnAl rubber, ZnAl резина, ZnAl
stoń / elephant / слон	UM-KID-P-001	
krokodyl / crocodile / крокодил	UM-KID-Q-001	
panda / panda / панда	UM-KID-U-001	

Uchwyt KID PLAY
Handle KID PLAY
Ручка KID PLAY



UM-KID-C-001



UM-KID-D-001



UM-KID-E-001

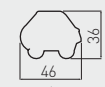

kwiatek / flower / цветок	UM-KID-C-001	guma, ZnAl rubber, ZnAl резина, ZnAl
samochód / car / автомобиль	UM-KID-D-001	
piłka / ball / мяч	UM-KID-E-001	

Uchwyt KID FARM
Handle KID FARM
Ручка KID FARM



UM-KID-W-001



UM-KID-X-001



UM-KID-Z-001



UM-UNICORN-RZ



konik / horse / лошадь	UM-KID-W-001	guma, ZnAl rubber, ZnAl резина, ZnAl
królik / rabbit / кролик	UM-KID-X-001	
piesek / dog / собака	UM-KID-Z-001	
jednorożec / unicorn / единорог	UM-UNICORN-RZ	



Wieszak 804
Hook 804
Крючок 804

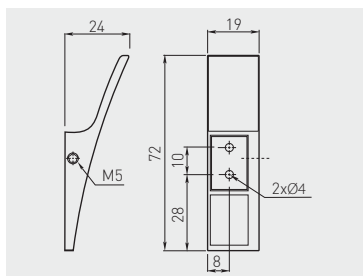

WZ-804-20-01	chrom / chrome / хром	ZnAl
WZ-804-20-05	aluminium / aluminium / алюминий	
WZ-804-20-06	stal szorstkowana / brushed steel / шлифованная сталь	

Wieszak TOLEDO A0
Hook TOLEDO A0
Крючок TOLEDO A0

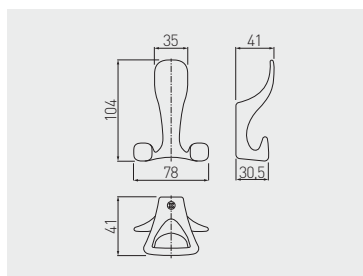

WZ-TOLED-A0-01	chrom / chrome / хром	ZnAl
WZ-TOLED-A0-02	satyna / satin / сатин	
WZ-TOLED-A0-05	aluminium / aluminium / алюминий	
WZ-TOLED-A0-06	stal szczotkowana / brushed steel / шлифованная сталь	
WZ-TOLED-A0-20M	czarny mat / black matt / чёрный матовый	

Wieszak TOLEDO B0
Hook TOLEDO B0
Крючок TOLEDO B0

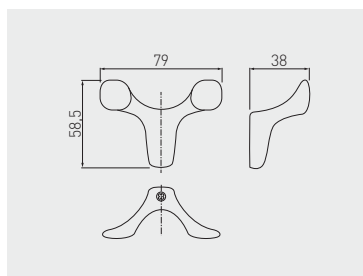

WZ-TOLED-B0-01	chrom / chrome / хром	ZnAl
WZ-TOLED-B0-02	satyna / satin / сатин	
WZ-TOLED-B0-05	aluminium / aluminium / алюминий	
WZ-TOLED-B0-06	stal szczotkowana / brushed steel / шлифованная сталь	
WZ-TOLED-B0-20M	czarny mat / black matt / чёрный матовый	

Wieszak TOLEDO C0
 Hook TOLEDO C0
 Крючок TOLEDO C0

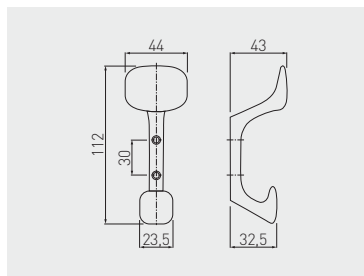

WZ-TOLED-C0-01	chrom / chrome / хром	ZnAl
WZ-TOLED-C0-02	satyna / satin / сатин	
WZ-TOLED-C0-05	aluminium / aluminium / алюминий	
WZ-TOLED-C0-06	stal szczotkowana / brushed steel / шлифованная сталь	
WZ-TOLED-C0-20M	czarny mat / black matt / чёрный матовый	

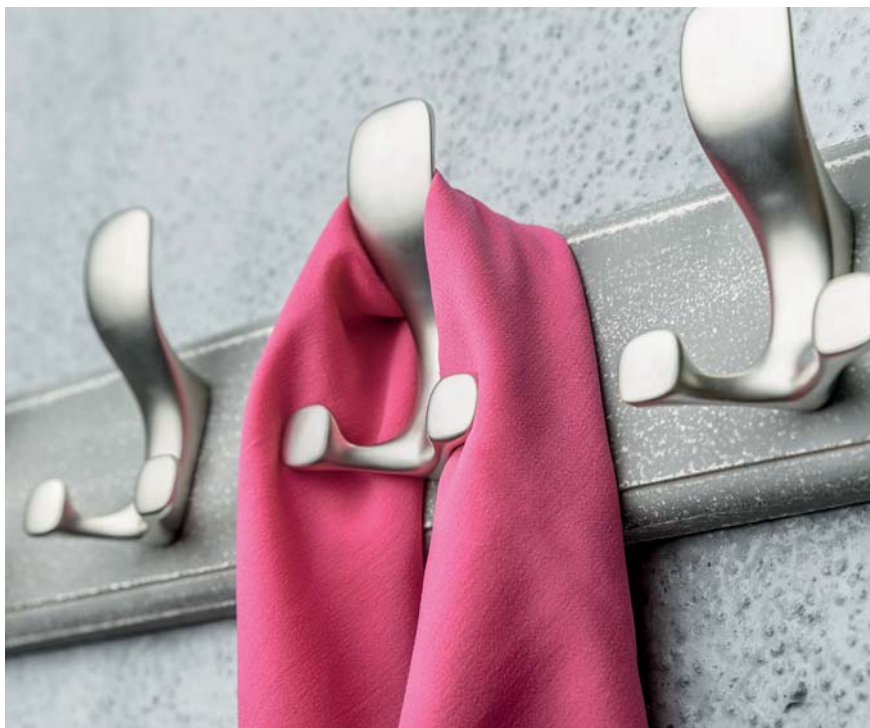

Wieszak WALENCIA
Hook WALENCIA
Крючок WALENCIA

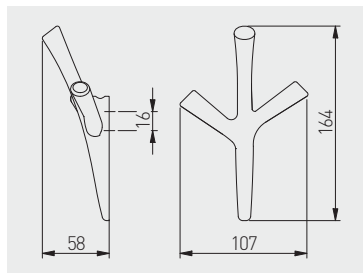

WZ-WALENCIA-01	chrom / chrome / хром	ZnAl
WZ-WALENCIA-06	stal szczotkowana / brushed steel / шлифованная сталь	
WZ-WALENCIA-20M	czarny mat / black matt / чёрный матовый	

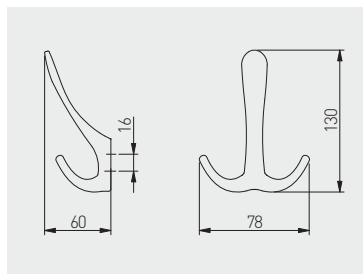

Wieszak CORDOBA
Hook CORDOBA
Крючок CORDOBA



WZ-CORDOBA-01	chrom / chrome / хром	ZnAl
WZ-CORDOBA-06	stal szczotkowana / brushed steel / шлифованная сталь	
WZ-CORDOBA-20M	czarny mat / black matt / чёрный матовый	

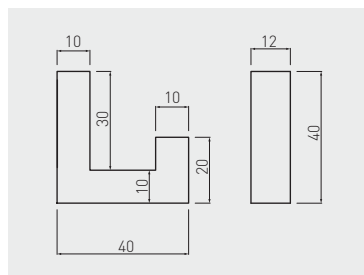

Wieszak K2201
Hook K2201
Крючок K2201

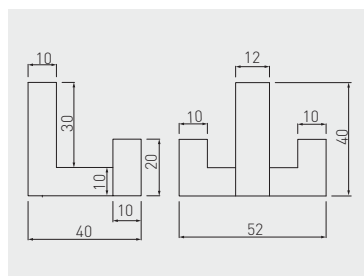

			
WZ-K2201-01		chrom / chrome / хром	ZnAl
WZ-K2201-06		stal szczotkowana / brushed steel / шлифованная сталь	
WZ-K2201-CZ		czarny / black / чёрный	

Wieszak K2202
Hook K2202
Крючок K2202



			
WZ-K2202-01		chrom / chrome / хром	ZnAl
WZ-K2202-06		stal szczotkowana / brushed steel / шлифованная сталь	
WZ-K2202-CZ		czarny / black / чёрный	

Wieszak K23-A0
Hook K23-A0
Крючок K23-A0

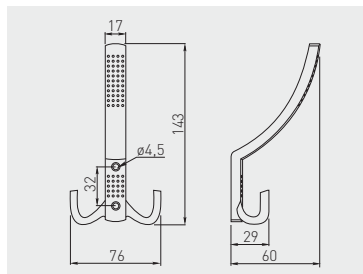

WZ-A0-K23-01	chrom / chrome / хром	ZnAl
WZ-A0-K23-02	satyna / satin / сатин	
WZ-A0-K23-03	mosiądz / brass / латунь	
WZ-A0-K23-04	antyczny mosiądz / antique brass / античная латунь	
WZ-A0-K23-05	aluminium / aluminium / алюминий	
WZ-A0-K23-06*	stal szorstkowana / brushed steel / шлифованная сталь	
WZ-A0-K23-07	antyczne srebro / antique silver / античное серебро	
WZ-A0-K23-20	czarny mat / black matt / чёрный матовый	

* Dostępny na zamówienie / Available only for individual order / Доступен под заказ

Wieszak K23-B0
Hook K23-B0
Крючок K23-B0

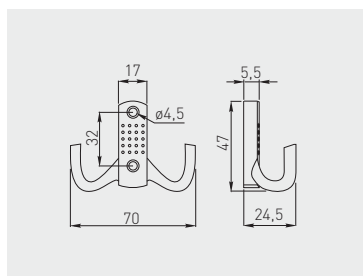

WZ-B0-K23-01	chrom / chrome / хром	ZnAl
WZ-B0-K23-02	satyna / satin / сатин	
WZ-B0-K23-03	mosiądz / brass / латунь	
WZ-B0-K23-04	antyczny mosiądz / antique brass / античная латунь	
WZ-B0-K23-05	aluminium / aluminium / алюминий	
WZ-B0-K23-06*	stal szorstkowana / brushed steel / шлифованная сталь	
WZ-B0-K23-07	antyczne srebro / antique silver / античное серебро	
WZ-B0-K23-20	czarny mat / black matt / чёрный матовый	

* Dostępny na zamówienie / Available only for individual order / Доступен под заказ

Wieszak K23-D1*
Hook K23-D1*
Крючок K23-D1*

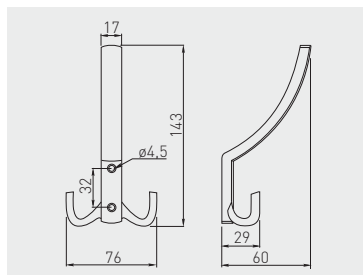

WZ-K23-D1-01	chrom / chrome / хром	ZnAl
WZ-K23-D1-02	satyna / satin / сатин	
WZ-K23-D1-05	aluminium / aluminium / алюминий	
WZ-K23-D1-06	stal szczotkowana / brushed steel / шлифованная сталь	

* Dostępny na zamówienie / Available only for individual order / Доступен под заказ

Wieszak K23-E1*
Hook K23-E1*
Крючок K23-E1*

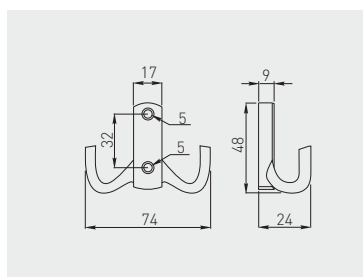

WZ-K23-E1-01	chrom / chrome / хром	ZnAl
WZ-K23-E1-02	satyna / satin / сатин	
WZ-K23-E1-05	aluminium / aluminium / алюминий	
WZ-K23-E1-06	stal szczotkowana / brushed steel / шлифованная сталь	

* Dostępny na zamówienie / Available only for individual order / Доступен под заказ

Wieszak K24-A0
Hook K24-A0
Крючок K24-A0

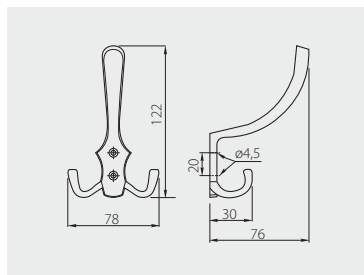

WZ-A0-K24-01	chrom / chrome / хром	ZnAl
WZ-A0-K24-02	satyna / satin / сатин	
WZ-A0-K24-03	mosiądz / brass / латунь	
WZ-A0-K24-04	antyczny mosiądz / antique brass / античная латунь	
WZ-A0-K24-05	aluminium / aluminium / алюминий	
WZ-A0-K24-07	antyczne srebro / antique silver / античное серебро	
WZ-A0-K24-20	czarny mat / black matt / чёрный матовый	

Wieszak K24-B0
Hook K24-B0
Крючок K24-B0

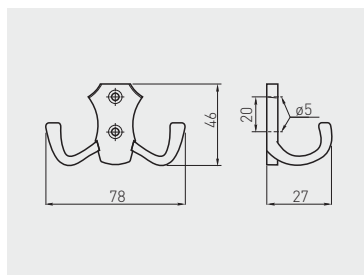

WZ-B0-K24-01	chrom / chrome / хром	ZnAl
WZ-B0-K24-02	satyna / satin / сатин	
WZ-B0-K24-03	mosiądz / brass / латунь	
WZ-B0-K24-04	antyczny mosiądz / antique brass / античная латунь	
WZ-B0-K24-05	aluminium / aluminium / алюминий	
WZ-B0-K24-07	antyczne srebro / antique silver / античное серебро	
WZ-B0-K24-20	czarny mat / black matt / чёрный матовый	



Wieszak K24-C0
Hook K24-C0
Крючок K24-C0

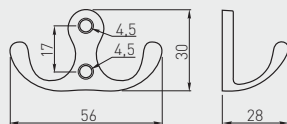

WZ-C0-K24-01	chrom / chrome / хром	ZnAl
WZ-C0-K24-02	satyna / satin / сатин	
WZ-C0-K24-03	mosiądz / brass / латунь	
WZ-C0-K24-04	antyczny mosiądz / antique brass / античная латунь	
WZ-C0-K24-05	aluminium / aluminium / алюминий	
WZ-C0-K24-20	czarny mat / black matt / чёрный матовый	

Wieszak MALAGA A0
Hook MALAGA A0
Крючок MALAGA A0

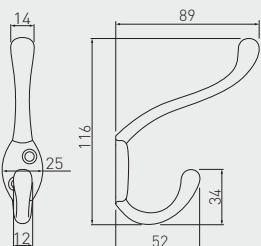

WA-MALAG-A0-01	chrom / chrome / хром	aluminium / aluminium / алюминий
WA-MALAG-A0-02	satyna / satin / сатин	
WA-MALAG-A0-05	aluminium / aluminium / алюминий	
WA-MALAG-A0-20	czarny / black / чёрный	

Wieszak MALAGA B0
Hook MALAGA B0
Крючок MALAGA B0

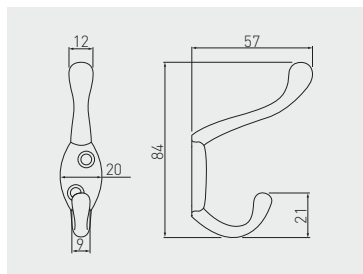

WA-MALAG-B0-01	chrom / chrome / хром	aluminium aluminium алюминий
WA-MALAG-B0-02	satyna / satin / сатин	
WA-MALAG-B0-05	aluminium / aluminium / алюминий	
WA-MALAG-B0-20	czarny / black / чёрный	

Wieszak MALAGA C0
Hook MALAGA C0
Крючок MALAGA C0

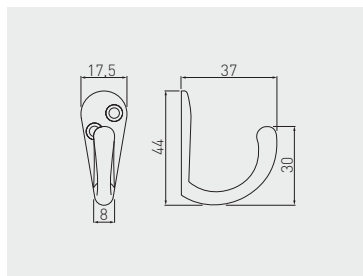

WZ-MALAG-C0-01	chrom / chrome / хром	ZnAl
WZ-MALAG-C0-02	satyna / satin / сатин	
WZ-MALAG-C0-05	aluminium / aluminium / алюминий	
WZ-MALAG-C0-20	czarny / black / чёрный	

Wieszak E18
Hook E18
Крючок E18

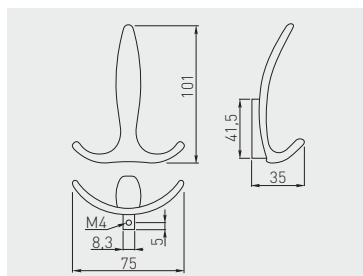

WZ-E-018-01	chrom / chrome / хром	ZnAl
WZ-E-018-02	satyna / satin / сатин	
WZ-E-018-05	aluminium / aluminium / алюминий	
WZ-E-018-06	stal szczotkowana / brushed steel / шлифованная сталь	
WZ-E-018-20M	czarny mat / black matt / чёрный матовый	

Wieszak D892
Hook D892
Крючок D892

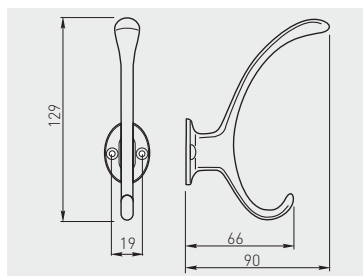

WZ-D-892-02	satyna / satin / сатин	ZnAl
WZ-D-892-05	aluminium / aluminium / алюминий	

Wieszak CORUNA-D
Hook CORUNA-D
Крючок CORUNA-D

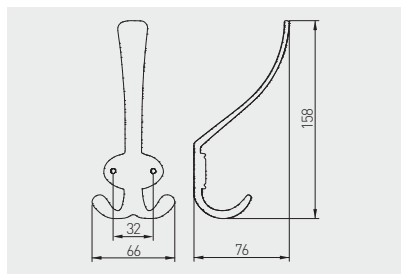

WZ-CORUNA-D-04	antyczny mosiądz / antique brass / античная латунь	ZnAl
WZ-CORUNA-D-07	antyczne srebro / antique silver / античное серебро	
WZ-CORUNA-D-17	brąz / bronze / коричневый	
WZ-CORUNA-D-20M	czarny mat / black matt / чёрный матовый	

Wieszak CORUNA-M
Hook CORUNA-M
Крючок CORUNA-M

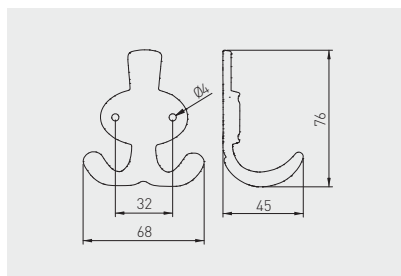

WZ-CORUNA-M-04	antyczny mosiądz / antique brass / античная латунь	ZnAl
WZ-CORUNA-M-07	antyczne srebro / antique silver / античное серебро	
WZ-CORUNA-M-17	brąz / bronze / коричневый	
WZ-CORUNA-M-20M	czarny mat / black matt / чёрный матовый	

Wieszak MADRYT
Hook MADRYT
Крючок MADRYT

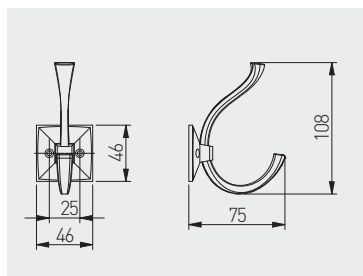

WZ-MADRYT-04	antyczny mosiądz / antique brass / античная латунь	ZnAl
WZ-MADRYT-07	antyczne srebro / antique silver / античное серебро	
WZ-MADRYT-15	antyczna miedź / antique copper / античная медь	
WZ-MADRYT-20M	czarny mat / black matt / чёрный матовый	

Wieszak CRAFT
Hook CRAFT
Крючок CRAFT

NEW

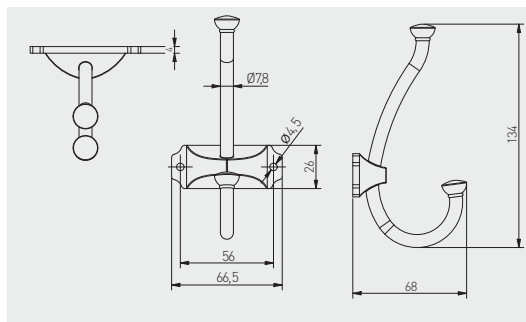

WZ-CRAFT-04	antyczny mosiądz / antique brass / античная латунь	ZnAl
WZ-CRAFT-07	antyczne srebro / antique silver / античное серебро	
WZ-CRAFT-15	antyczna miedź / antique copper / античная медь	
WZ-CRAFT-20M	czarny mat / black matt / чёрный матовый	

Wieszak ORVIETO A0
 Hook ORVIETO A0
 Крючок ORVIETO A0

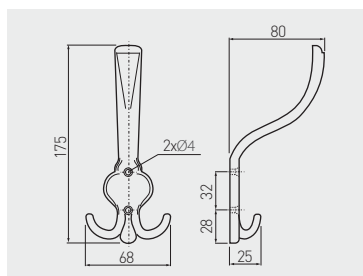

WZ-ORVIE-A0-09

antyczny mosiądz szczotkowany
 antique brushed brass
 античная шлифованная латунь

ZnAl

Wieszak ORVIETO B0
 Hook ORVIETO B0
 Крючок ORVIETO B0

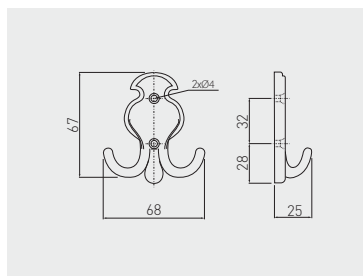

WZ-ORVIE-B0-09

antyczny mosiądz szczotkowany
 antique brushed brass
 античная шлифованная латунь

ZnAl

Wieszak K24
Hook K24
Крючок K24

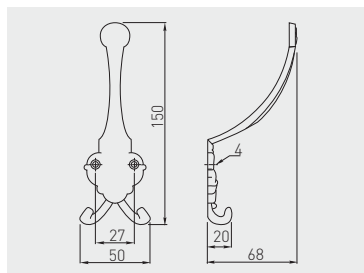

WZ-00-K24-04

antyczny mosiądz / antique brass / античная латунь

ZnAl



Podpórka pod półkę BELT
Shelf support BELT
Полкодержатель BELT

NEW

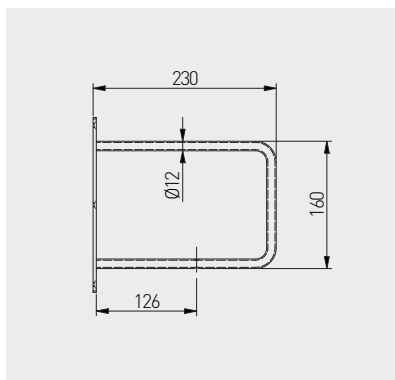

			
PP-BELT-20M	czarny / black / чёрный	stal / steel / сталь	30

Podpórka pod półkę FLAT
Shelf support FLAT
Полкодержатель FLAT

NEW

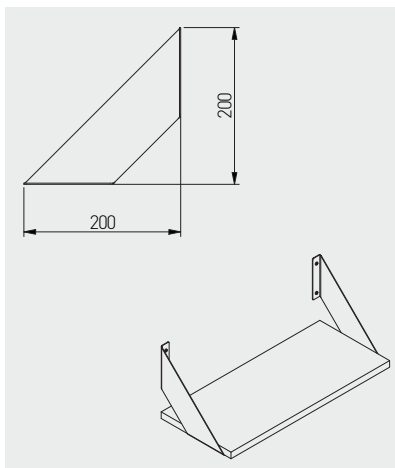

			
PP-FLAT-20M	czarny / black / чёрный	stal / steel / сталь	15

Podpórka pod półkę GALA
Shelf support GALA
Полкодержатель GALA

NEW

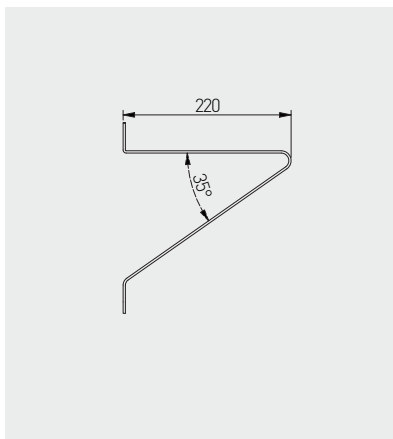

PP-GALA-20M	czarny / black / чёрный	stal / steel / сталь	30

Podpórka pod półkę GINO
Shelf support GINO
Полкодержатель GINO

NEW

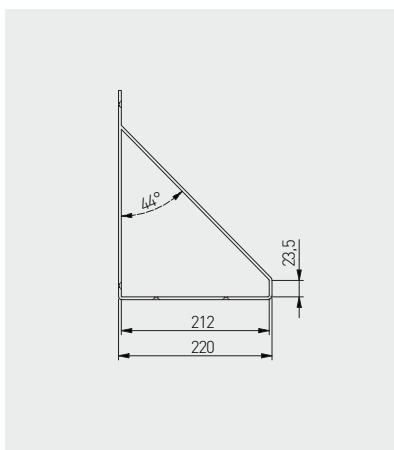

PP-GINO-20M	czarny / black / чёрный	stal / steel / сталь	30



Podpórka pod półkę INGRID
Shelf support INGRID
Полкодержатель INGRID

NEW

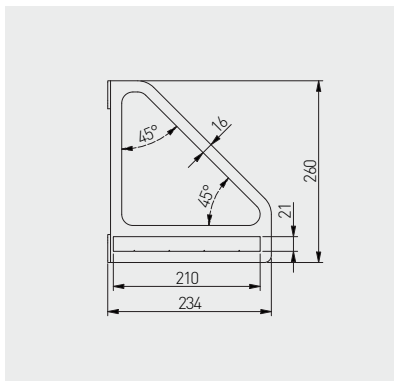

PP-INGRID-20M	czarny / black / чёрный	stal / steel / сталь	20

Podpórka pod półkę NEO
Shelf support NEO
Полкодержатель NEO

NEW

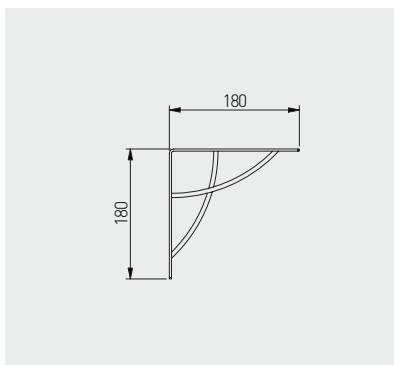

PP-NEO-20M	czarny / black / чёрный	stal / steel / сталь	20



Podpórka pod półkę BAR
Shelf support BAR
Полкодержатель BAR

NEW

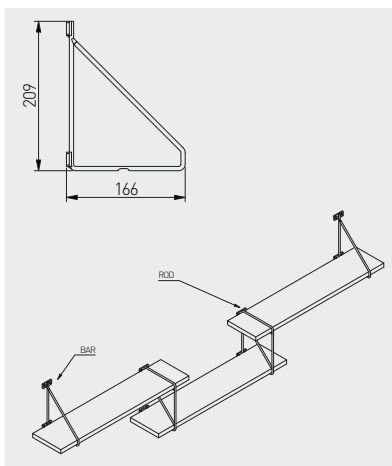

PP-BAR-20M

czarny / black / чёрный

stal / steel / сталь

20

Podpórka pod półkę ROD
Shelf support ROD
Полкодержатель ROD

NEW

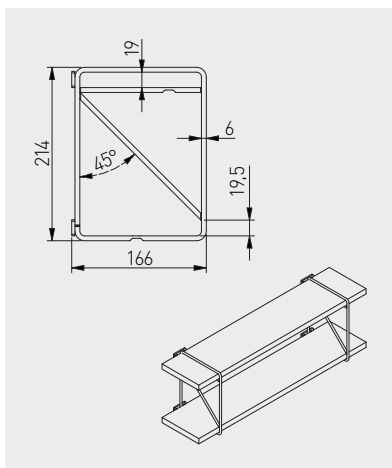

PP-ROD-20M

czarny / black / чёрный

stal / steel / сталь

20

Podpórka pod półkę TREE
Shelf support TREE
Полкодержатель TREE

NEW

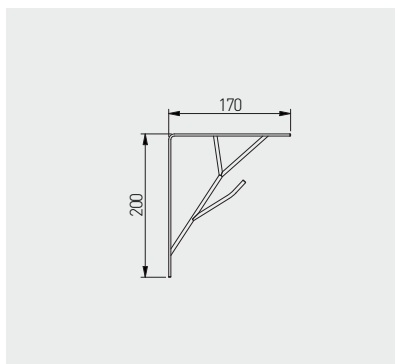

			
PP-TREE-20M	czarny / black / чёрный	stal / steel / сталь	20

Podpórka pod półkę WIRE
Shelf support WIRE
Полкодержатель WIRE



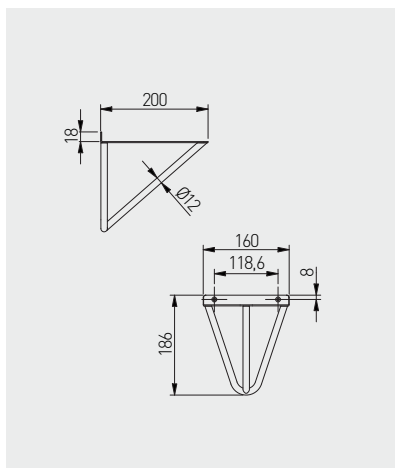

NEW

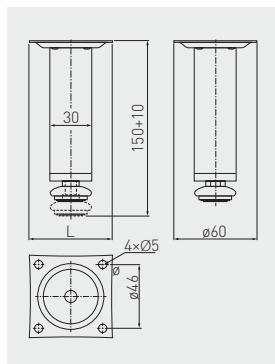

			
PP-WIRE-20M	czarny / black / чёрный	stal / steel / сталь	30



Nóżka BD-150 z regulacją
Adjustable leg BD-150
Ножка BD-150 с регулировкой



		 H mm			
NM-BD-150-01		150 + 10	chrom / chrome / хром	stal / steel / сталь	80
NM-BD-150-02			satyna / satin / сатин		

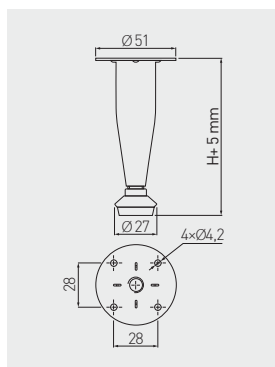



Nóżka BD-03 z regulacją
Adjustable leg BD-03
Ножка BD-03 с регулировкой

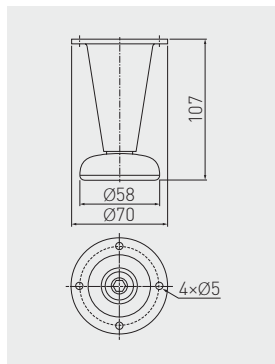

		 H mm			
NM-BD-003-01		100 + 5	chrom / chrome / хром	stal / steel / сталь	100
NM-BD-003-02			satyna / satin / сатин		

Nóżka BD-780
Leg BD-780
Ножка BD-780



	 mm			
NM-BD-780-M1	107	chrom / chrome / хром	stal / steel / сталь	50
NM-BD-780-M2		satyna / satin / сатин		
NM-BD-780-M5		aluminium / aluminium / алюминий		

Nóżka STR-50
Leg STR-50
Ножка STR-50

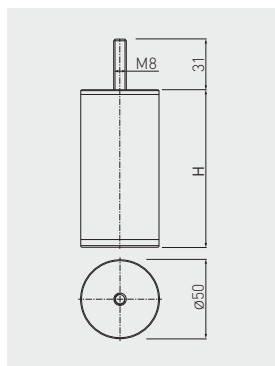

	 mm			
NM-STR50-100-01	100	chrom chrome хром	stal, tworzywo steel, plastic сталь, пластмасса	80
NM-STR50-120-01	120			
NM-STR50-150-01*	150			

* Dostępny na zamówienie / Available only for individual order / Доступен под заказ

Nóżka STR-60*
Leg STR-60*
Ножка STR-60*

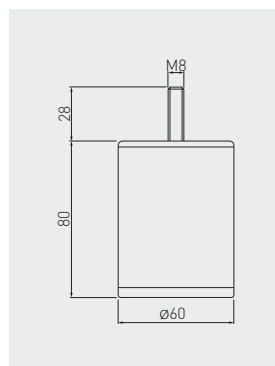



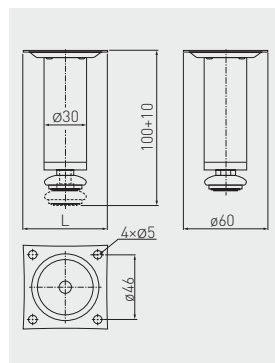

	 H mm			
NM-STR60-80-01	80	chrom chrome хром	stal, tworzywo steel, plastic сталь, пластмасса	100

* Dostępny na zamówienie / Available only for individual order / Доступен под заказ





Nóżka BD-100 z regulacją
Adjustable leg BD-100
Ножка BD-100 с регулировкой

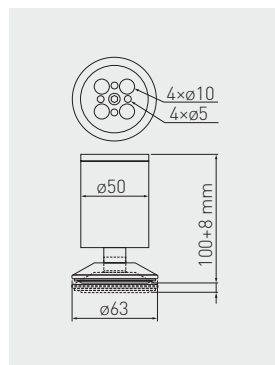

	 H mm			
NM-BD-100-01	100 + 10	chrom / chrome / хром	stal steel сталь	100
NM-BD-100-02		satyna / satin / сатин		
NM-BD-100-05		aluminium / aluminium / алюминий		
NM-BD-100-06		stal szczotkowana / brushed steel / шлифованная сталь		

Nóżka BD-762 z regulacją
Adjustable leg BD-762
Ножка BD-762 с регулировкой



	 mm			
NM-BD-762-01	100 + 8	chrom / chrome / хром	ZnAl, stal ZnAl, steel	50
NM-BD-762-05		aluminium / aluminium / алюминий	ZnAl, сталь	

Nóżka BD-867
Leg BD-867
Ножка BD-867

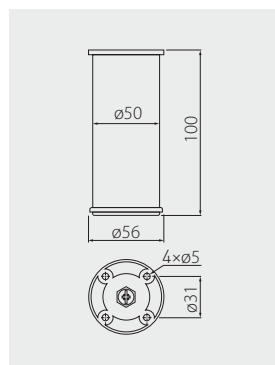

	 mm			
NM-BD867-100	100	aluminium / aluminium / алюминий	aluminium / aluminium / алюминий	50

Nóżka BD-868
 Leg BD-868
 Ножка BD-868

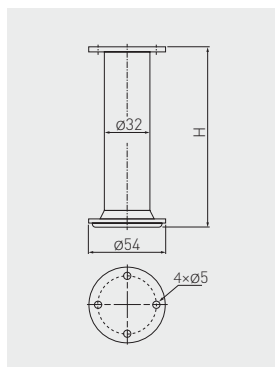

NM-BD868-100	100	aluminium / aluminium / алюминий	aluminium / aluminium / алюминий	50
NM-BD868-150	150			



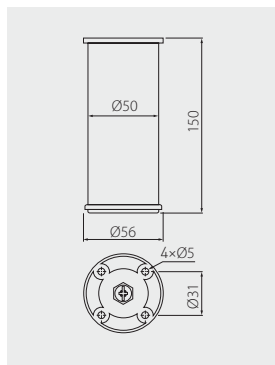

Nóżka BD-869
 Leg BD-869
 Ножка BD-869

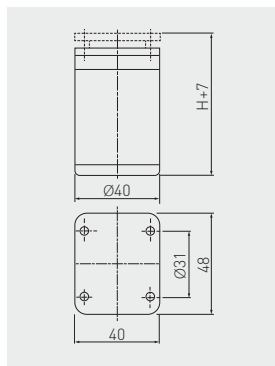

NM-BD869-150	150	aluminium / aluminium / алюминий	aluminium / aluminium / алюминий	50
--------------	-----	----------------------------------	----------------------------------	----





Nóżka DAP-77 z regulacją
Adjustable leg DAP-77
Ножка DAP-77 с регулировкой высоты

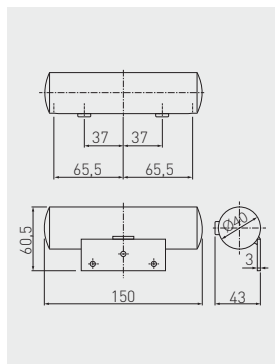

	 mm			
NM-DAP77-60	60 + 7	aluminium / aluminium / алюминий	aluminium, tworzywo aluminium, plastic алюминий, пластмасса	100
NM-DAP77-100	100 + 7			
NM-DAP77-150	150 + 7			

Nóżka BAHIA
Leg BAHIA
Ножка BAHIA



	 mm			
NM-BAHIA40-150-01	43	chrom / chrome / хром	stal, tworzywo steel, plastic сталь, пластмасса	50

Nóżka SQ-40 z regulacją
Adjustable leg SQ-40
Ножка SQ-40 с регулировкой высоты

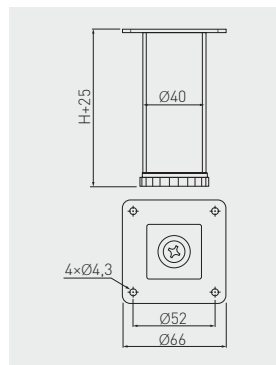





NM-SQ40ADJ-060	60 + 25	chrom / chrome / хром	stal / steel / сталь	100
NM-SQ40ADJ-100	100 + 25	chrom / chrome / хром		50

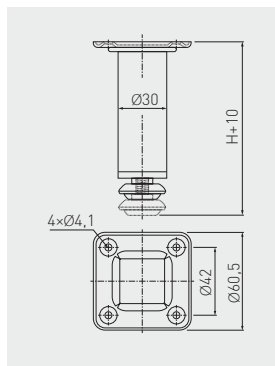

Nóżka SQA z regulacją
Adjustable leg SQA
Ножка SQA с регулировкой высоты



	 mm			
NM-SQA100-01	100 + 10	chrom / chrome / хром	stal / steel / сталь	100
NM-SQA150-01*	150 + 10			

* Dostępny na zamówienie / Available only for individual order / Доступен под заказ

Nóżka BD-727
Leg BD-727
Ножка BD-727

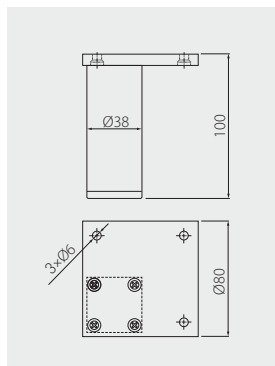

	 mm			
NM-BD727-100	100	aluminium / aluminium / алюминий	aluminium / aluminium / алюминий	50

Nóżka BD-739
Leg BD-739
Ножка BD-739

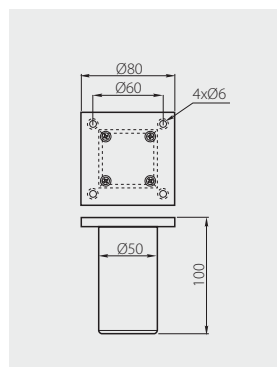

	 H mm			
NM-BD-739-05	100	aluminium / aluminium / алюминий	aluminium / aluminium / алюминий	50

Nóżka DAK-27 z regulacją
Adjustable leg DAK-27
Ножка DAK-27 с регулировкой высоты

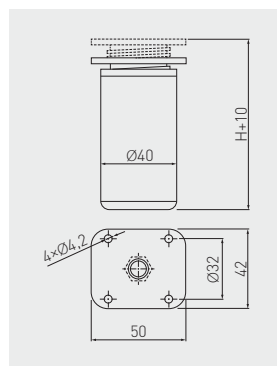

	 H mm			
NM-DAK27-060	60 + 10	aluminium aluminium алюминий	aluminium, tworzywo aluminium, plastic алюминий, пластмасса	100
NM-DAK27-080	80 + 10			
NM-DAK27-100	100 + 10			
NM-DAK27-120	120 + 10			
NM-DAK27-150	150 + 10			



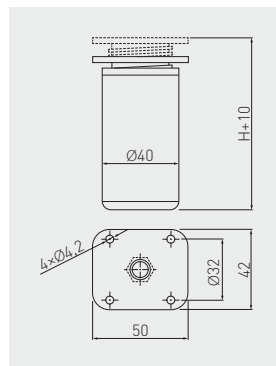

Nóżka NACK z regulacją
Adjustable leg NACK
Ножка NACK с регулировкой высоты

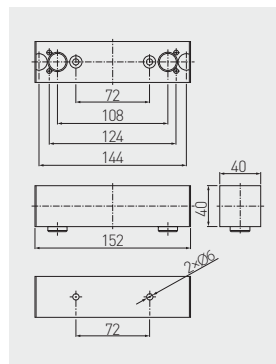

	 H mm			
NM-NACK27651-06	60 + 10	chrom chrome хром	tworzywo, aluminium plastic, aluminium пластмасса, алюминий	100

Nóżka TOKYO*
Leg TOKYO*
Ножка TOKYO*



	 H mm			
NM-TOKYO40-150-01	40	chrom / chrome / хром	stal, tworzywo steel, plastic сталь, пластмасса	50

* Dostępny na zamówienie / Available only for individual order / Доступен под заказ

Nóżka BD-01
Leg BD-01
Ножка BD-01

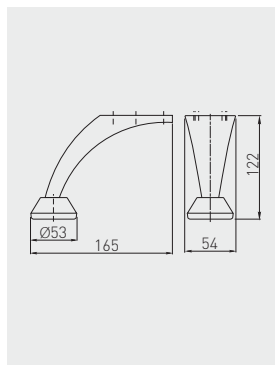

NM-BD-001-M1B



122



chrom / chrome / хром



stal / steel / сталь



80

Nóżka BD-712
Leg BD-712
Ножка BD-712

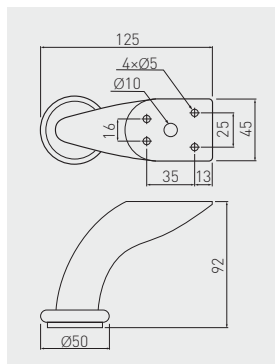

NM-BD-712-M1



92



chrom / chrome / хром



stal / steel / сталь



50

*Dostępny na zamówienie / Available only for individual order / Доступен под заказ

Nóżka STGC 50*
Leg STGC 50*
Ножка STGC 50*

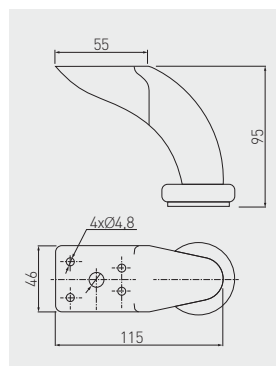



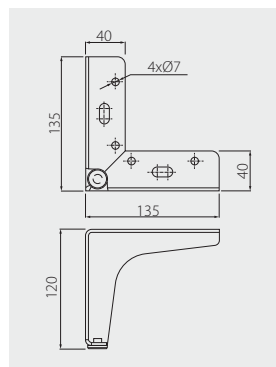

	 H mm			
NM-STGC50-95-01	95	chrom / chrome / хром	stal / steel / сталь	100

* Dostępny na zamówienie / Available only for individual order / Доступен под заказ

Nóżka STGY 135
Leg STGY 135
Ножка STGY 135



	 H mm			
NM-STGY135-100-01	100	chrom / chrome / хром	stal, tworzywo steel, plastic сталь, пластик	50
NM-STGY135-130-01*	130			
NM-STGY135-150-01*	150			

* Dostępny na zamówienie / Available only for individual order / Доступен под заказ

Nóżka STOMP
Leg STOMP
Ножка STOMP

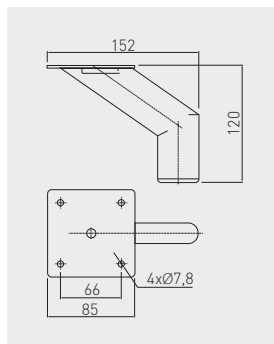

		 H mm			
NM-STOMP-100-01*		100	chrom / chrome / хром	stal steel сталь	100
NM-STOMP-120-10*		120	biały / white / белый		60
NM-STOMP-120-20			czarny / black / чёрный		
NM-STOMP-130-01*		130	chrom / chrome / хром		
NM-STOMP-130-06*			stal szczotkowana / brushed steel / шлифованная сталь		
NM-STOMP-130-20*		150	czarny / black / чёрный		
NM-STOMP-150-01*			chrom / chrome / хром		
NM-STOMP-160-01*		160	stal szczotkowana / brushed steel / шлифованная сталь		
NM-STOMP-160-06*			czarny / black / чёрный		
NM-STOMP-160-20*					

*Dostępny na zamówienie / Available only for individual order / Доступен под заказ

Nóżka MDN-D4
Leg MDN-D4
Ножка MDN-D4

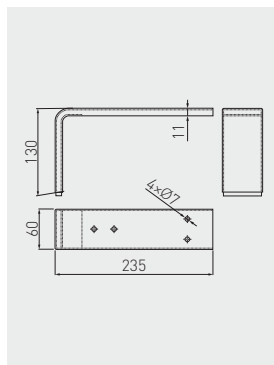

		 H mm			
NM-MDN-D4-01		130	chrom / chrome / хром	stal / steel / сталь	25



Nóżka MDN-926
Leg MDN-926
Ножка MDN-926

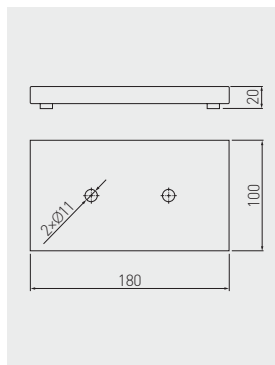

NM-MDN926-01	20	chrom / chrome / хром	stal / steel / сталь	50
--------------	----	-----------------------	----------------------	----



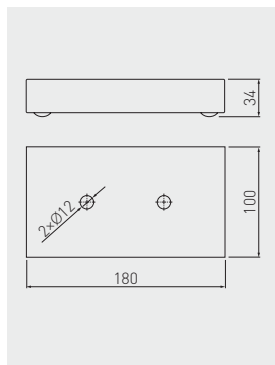

Nóżka MDN-927
Leg MDN-927
Ножка MDN-927

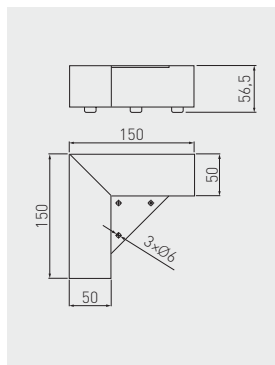

NM-MDN927-01	34	chrom / chrome / хром	stal / steel / сталь	50
--------------	----	-----------------------	----------------------	----

Nóżka MDN-941
Leg MDN-941
Ножка MDN-941



				
NM-MDN941-01	56	chrom / chrome / хром	stal / steel / сталь	25

Nóżka STSL*
Leg STSL*
Ножка STSL*

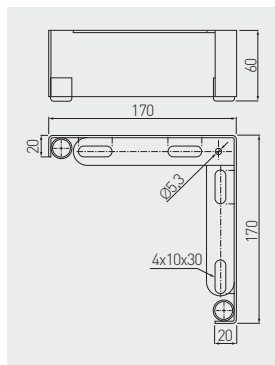

				
NM-STSL-170-60-01	60	chrom / chrome / хром	stal / steel / сталь	40

* Dostępny na zamówienie / Available only for individual order / Доступен под заказ

Ślizgacz WPJ z regulacją
Adjustable furniture slider WPJ
Опора WPJ с регулировкой

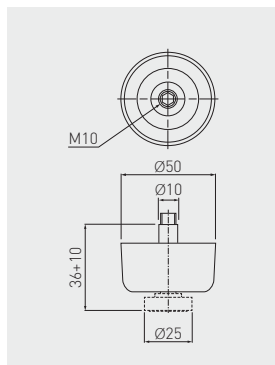

NM-WPJ22-D20	36 + 10	czarny / black / чёрный	tworzywo / plastic / пластмасса	5
--------------	---------	-------------------------	---------------------------------	---

Ślizgacz SLZ pojedynczy
Furniture slider SLZ single
Опора SLZ одинарная

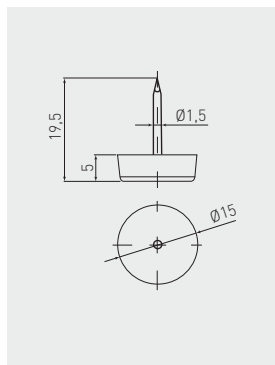

BP-SLZIGW-10	czarny / black / чёрный	tworzywo / plastic / пластмасса
--------------	-------------------------	---------------------------------

Ślizgacz SLZ podwójny
Furniture slider SLZ double
Опора SLZ двойная

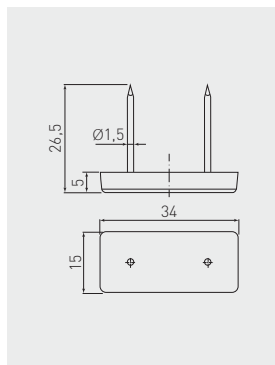

			
BP-SLZIGW-21	czarny black чёрный	tworzywo plastic пластмасса	250

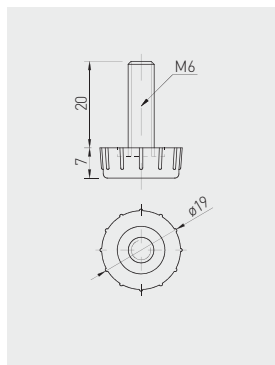

Stopka M6 regulowana
Foot M6 adjustable
Ножка M6 с регулировкой

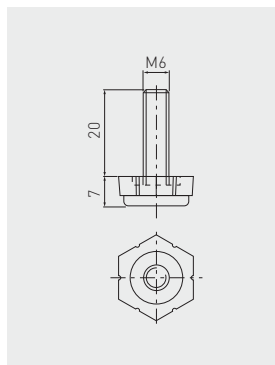

		
NM-STOPKA-M6	osypk galvanized гальваника	stal, tworzywo steel, plastic сталь, пластмасса

Stopka M6 regulowana sześciokątna
 Foot M6 adjustable hexagonal
 Ножка М6 с регулировкой (шестигранная)



			
NM-STOPK SZESTK-M6	ocynk galvanized гальваника	stal, tworzywo steel, plastic сталь, пластмасса	250

Mufa M6
 Socket M6
 Муфта М6







NM-MUFAWB-00

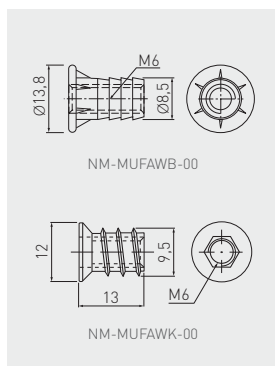







NM-MUFAWK-00

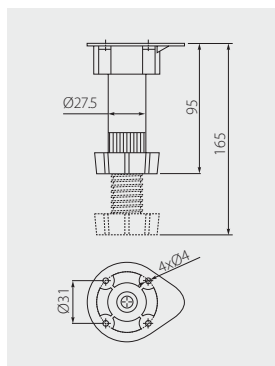

				
NM-MUFAWB-00	wbijana screw-in sleeve врезная	srebrny silver серебряный	ZnAl	2500
NM-MUFAWK-00	wkręcana screwed для вкручивания			4000

Nóżka DPD z regulacją
Adjustable leg DPD
Ножка DPD с регулировкой



	 H mm	 kg			
NM-DPD20-100	95 – 165	60	czarny / black / чёрный	tworzywo / plastic / пластмасса	200

Klip do nóżki DPD
Plinth clip DPD
Клипса к ножке DPD

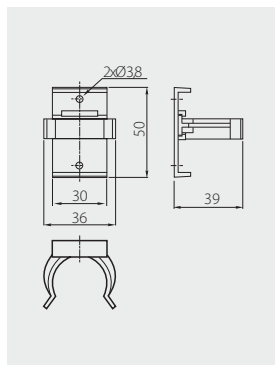

			
NM-KL-DPL-20	czarny / black / чёрный	tworzywo / plastic / пластмасса	1500

Nóżka DPA
Leg DPA
Ножка DPA

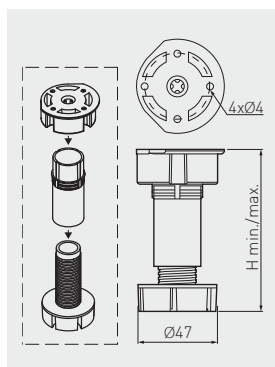

		H mm	kg			
NM-DPA20-100	pakowane w karton packing in box картонная упаковка	87 - 120	100	czarny black чёрный	tworzywo plastic пластмасса	250
NM-DPA20-150		137 - 170				200
NM-DPA20-100W	pakowane w worek packing in plastic bag полиэтиленовый пакет	87 - 120				100
NM-DPA20-150W		137 - 170				400

Klip do nóżki DPA
Plinth clip DPA
Клипса к ножке DPA

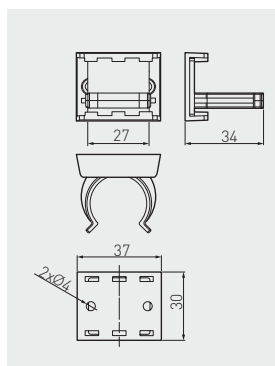

NM-KL-DPA-20	czarny / black / чёрный	tworzywo / plastic / пластмасса
--------------	-------------------------	---------------------------------

Klucz do regulacji nóg DPA / DPD
 Leg adjustment key DPA / DPD
 Ключ регулировки ноги DPA / DPD

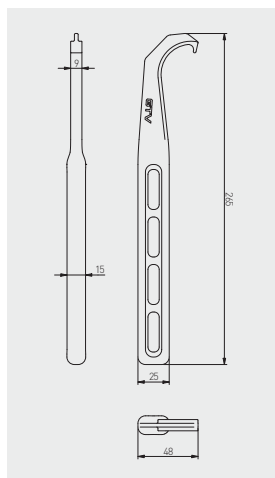

00-KLUCZREG-DPADPD

niebieski / blue / синий

tworzywo / plastic / пластмасса

Nóżka MLA-50 z regulacją
 Adjustable leg MLA-50
 Ножка MLA-50 с регулировкой

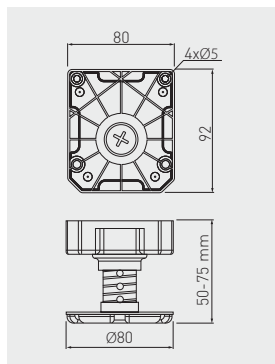

NM-MLA-50-75

50-75

450





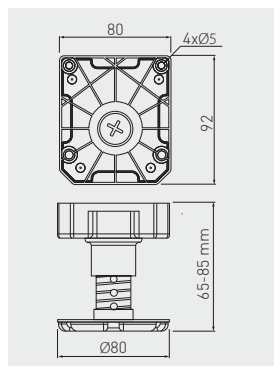

czarny / black / чёрный

tworzywo / plastic / пластмасса

50

Nóżka MLA-65 z regulacją
Adjustable leg MLA-65
Ножка MLA-65 с регулировкой



	 H mm	 kg			
NM-MLA-65-85	65 - 85	450	czarny / black / чёрный	tworzywo / plastic / пластмасса	50



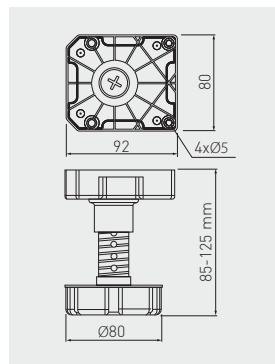



Nóżka MLA-85 z regulacją
Adjustable leg MLA-85
Ножка MLA-85 с регулировкой

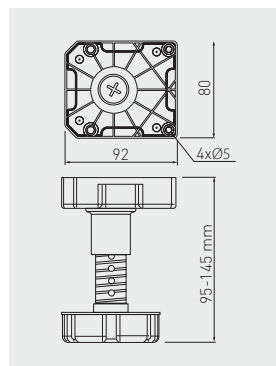

	 H mm	 kg			
NM-MLA-85-125	85 - 125	450	czarny / black / чёрный	tworzywo / plastic / пластмасса	50

Nóżka MLA-95 z regulacją
Adjustable leg MLA-95
Ножка MLA-95 с регулировкой



	 H mm	 kg			
NM-MLA-95-145	95 – 145	450	czarny / black / чёрный	tworzywo / plastic / пластмасса	100

Nóżka MLA-125 z regulacją
Adjustable leg MLA-125
Ножка MLA-125 с регулировкой

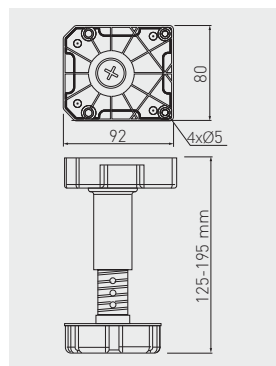

	 H mm	 kg			
NM-MLA-125-195	125 – 195	450	czarny / black / чёрный	tworzywo / plastic / пластмасса	50

Klip do nóżek MLA
 Clip for MLA legs
 Клипса к ножке MLA

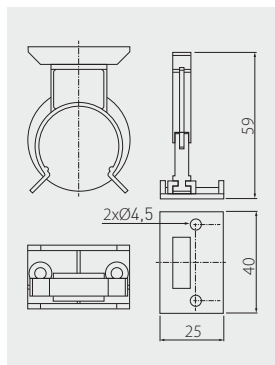

NM-MLA-KL



czarny / black / чёрный



tworzywo / plastic / пластмасса



100



Noga A6 z regulacją
Adjustable leg A6
Опора A6 с регулировкой

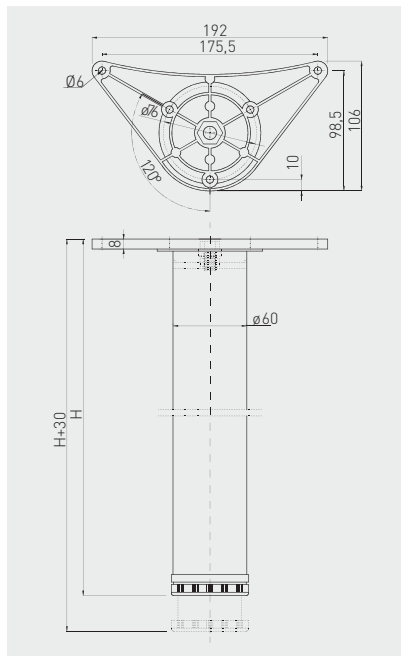

NM-A60710-01	710 + 30	chrom / chrome / хром	ZnAl, stal ZnAl, steel ZnAl, сталь	4
NM-A60710-02		satyna / satin / сатин		
NM-A60710-05		aluminium / aluminium / алюминий		
NM-A60710-06*		stal szczotkowana / brushed steel / шлифованная сталь		
NM-A60710-10N*		biały / white / белый		
NM-A60710-20		czarny / black / чёрный		
NM-A60710-80N	srebrny / silver / серебристый			
NM-A60820-01	820 + 30	chrom / chrome / хром		
NM-A60820-02		satyna / satin / сатин		
NM-A60820-05		aluminium / aluminium / алюминий		
NM-A60820-06*		stal szczotkowana / brushed steel / шлифованная сталь		
NM-A60820-10N*		biały / white / белый		
NM-A60820-20*		czarny / black / чёрный		
NM-A60820-80N*	srebrny / silver / серебристый			
NM-A60870-01*	710 + 30	chrom / chrome / хром		
NM-A60870-02*		satyna / satin / сатин		
NM-A60870-05*		aluminium / aluminium / алюминий		
NM-A60870-06*		stal szczotkowana / brushed steel / шлифованная сталь		
NM-A60870-10N*		biały / white / белый		
NM-A60870-20*		czarny / black / чёрный		
NM-A60870-80N*	srebrny / silver / серебристый			
NM-A61100-01	1100 + 30	chrom / chrome / хром		
NM-A61100-02		satyna / satin / сатин		
NM-A61100-05		aluminium / aluminium / алюминий		
NM-A61100-06		stal szczotkowana / brushed steel / шлифованная сталь		
NM-A61100-10N*		biały / white / белый		
NM-A61100-20*		czarny / black / чёрный		

* Dostępny na zamówienie / Available only for individual order / Доступен под заказ

Noga NM-A80 z regulacją
Adjustable leg NM-A80
Опора NM-A80 с регулировкой

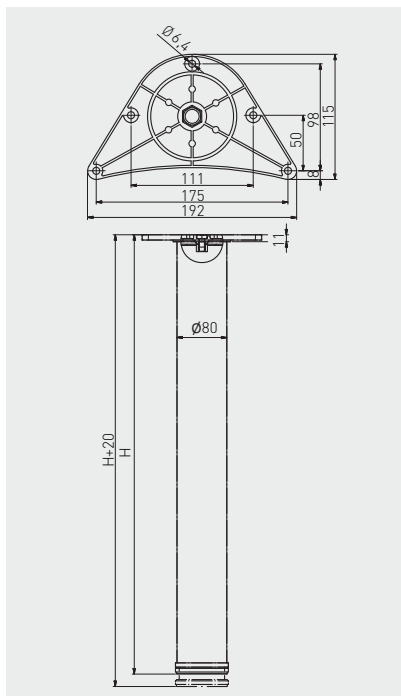

NM-A80710-01*	710 + 20	chrom / chrome / хром	ZnAl, stal ZnAl, steel ZnAl, сталь	2
NM-A80710-02*		satyna / satin / сатин		
NM-A80710-03*		złoty / gold / золото		
NM-A80710-05*		aluminium / aluminium / алюминий		
NM-A80710-06*		stal szczotkowana / brushed steel / шлифованная сталь		
NM-A80710-10*		biały / white / белый		
NM-A80710-20*		czarny / black / чёрный		
NM-A80710-80*		srebrny / silver / серебристый		
NM-A80870-01*	870 + 20	chrom / chrome / хром		
NM-A80870-02*		satyna / satin / сатин		
NM-A80870-03*		złoty / gold / золото		
NM-A80870-05*		aluminium / aluminium / алюминий		
NM-A80870-06*		stal szczotkowana / brushed steel / шлифованная сталь		
NM-A80870-10*		biały / white / белый		
NM-A80870-20*		czarny / black / чёрный		
NM-A80870-80*		srebrny / silver / серебристый		

* Dostępny na zamówienie / Available only for individual order / Доступен под заказ

Noga G6 z regulacją
Adjustable leg G6
Опора G6 с регулировкой

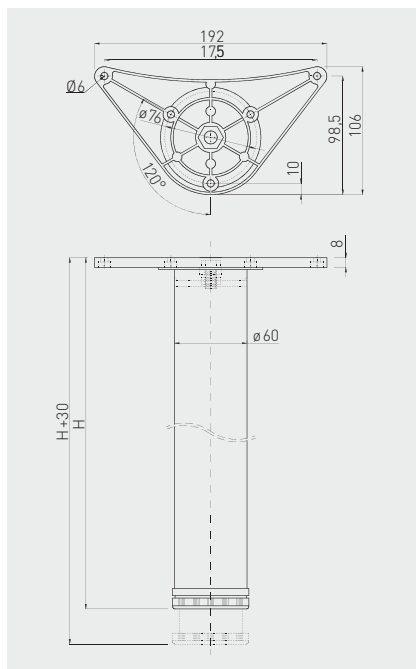



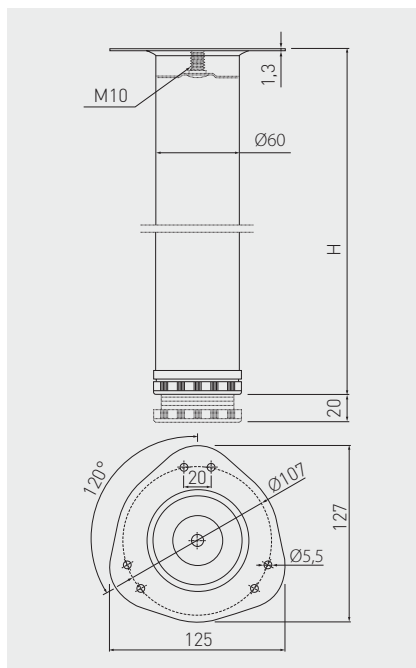

		 H mm			
NM-G60710-01N		710 + 30	chrom / chrome / хром	ZnAl, stal ZnAl, steel ZnAl, сталь	4
NM-G60710-02N			satyna / satin / сатин		
NM-G60710-05N			aluminium / aluminium / алюминий		
NM-G60710-06N			stal szorstkowana / brushed steel / шлифованная сталь		
NM-G60710-10N*			biały / white / белый		
NM-G60710-20N			czarny / black / чёрный		
NM-G60710-80N			srebrny/ silver/ серебристый		
NM-G60820-01N		820 + 30	chrom / chrome / хром		
NM-G60820-05N			aluminium / aluminium / алюминий		
NM-G60820-06N			stal szorstkowana / brushed steel / шлифованная сталь		
NM-G60820-10N*			biały / white / белый		
NM-G60820-20N			czarny / black / чёрный		
NM-G61100-01N		1100 + 30	chrom / chrome / хром		
NM-G61100-20N			czarny / black / чёрный		

* Na zamówienie dostępna w kolorze białym / For special orders available in white color / Под заказ доступна в белом цвете

Noga S6 z regulacją
Adjustable leg S6
Опора S6 с регулировкой



		 mm			
NM-S60710-01A	710 + 20		chrom / chrome / хром	stal steel сталь	4
NM-S60710-02A			satyna / satin / сатин		
NM-S60710-05A			aluminium / aluminium / алюминий		
NM-S60710-06A*			stal szcztokowana / brushed steel / шлифованная сталь		
NM-S60710-10A*			biały / white / белый		
NM-S60710-20A	820 + 20		czarny / black / чёрный		
NM-S60820-01A			chrom / chrome / хром		
NM-S60820-02A*			satyna / satin / сатин		
NM-S60820-05A			aluminium / aluminium / алюминий		
NM-S60820-06A*			stal szcztokowana / brushed steel / шлифованная сталь		
NM-S60820-10A*			biały / white / белый		
NM-S60820-20A*	czarny / black / чёрный				

* Dostępny na zamówienie / Available only for individual order / Доступен под заказ

Noga F-50 składana
 Leg F-50 foldable
 Складная опора F-50

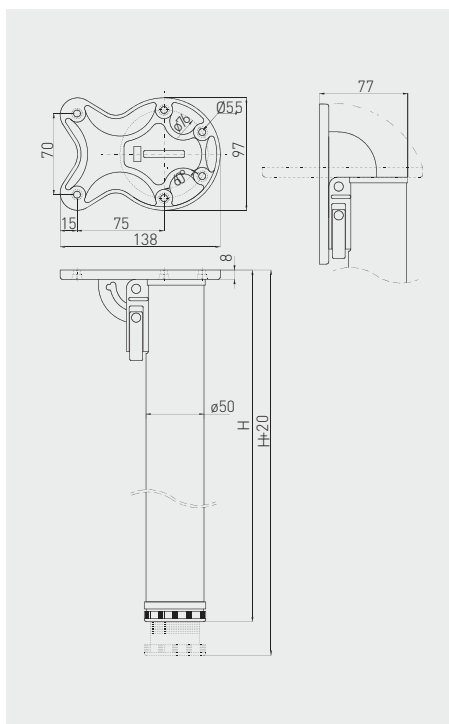





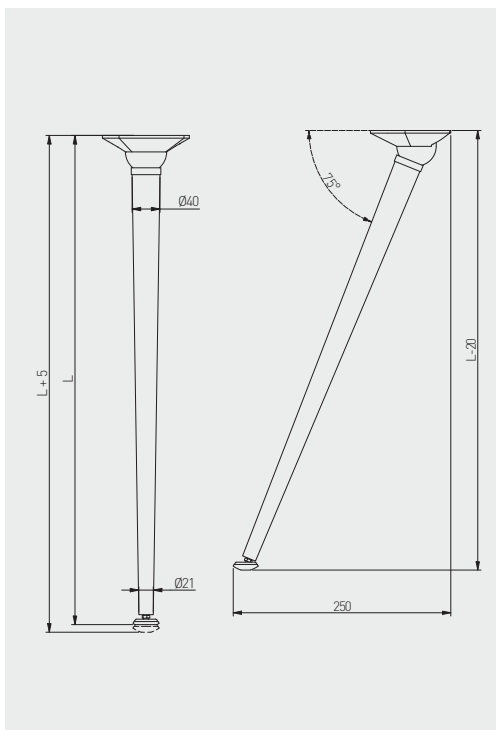

		 H mm					
NM-F50710-01		710 + 20	chrom / chrome / хром				
NM-F50710-06			stal szczotkowana / brushed steel / шлифованная сталь				
NM-F50710-10			biały / white / белый				
NM-F50710-20			czarny / black / чёрный				
NM-F50870-01		870 + 20	chrom / chrome / хром				
NM-F50870-06			stal szczotkowana / brushed steel / шлифованная сталь				
NM-F50870-10*			biały / white / белый				
NM-F50870-20			czarny / black / чёрный				

* Dostępny na zamówienie / Available only for individual order / Доступен под заказ

Noga X-LINE skośna
X-LINE oblique leg
X-LINE косая нога

NEW



		 mm			
NM-X-LINE40710-01		710	chrom / chrome / хром	stal, tworzywo steel, plastic сталь, пластмасса	4
NM-X-LINE40710-20			czarny / black / чёрный		
NM-X-LINE40710-10			biały / white / белый		
NM-X-LINE40820-20*		820	czarny / black / чёрный		
NM-X-LINE40870-20*		870			
NM-X-LINE401100-20*		1100			







* Dostępny na zamówienie / Available only for individual order / Доступен под заказ

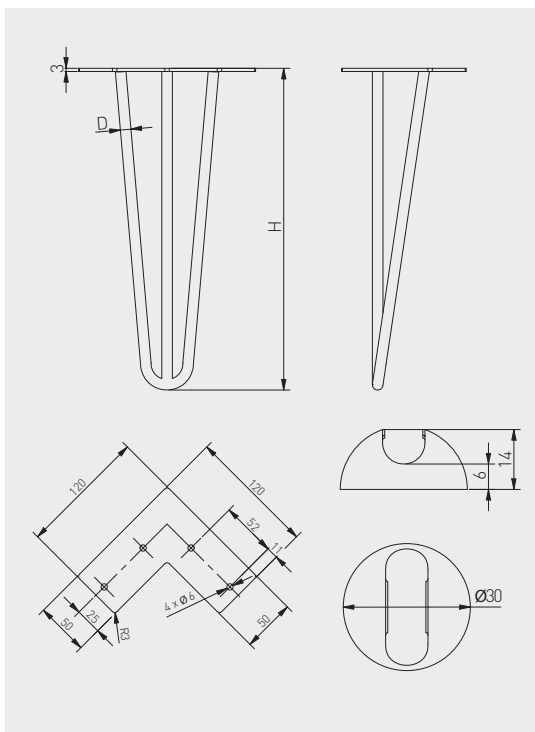

Noga ARTO – HAIRPIN
 ARTO leg – HAIRPIN
 ARTO нога – HAIRPIN

NEW









	 H mm	 ØD (mm)			
NM-ARTO-10-3R304-20M	304	ø10	czarny mat black matt чёрный матовый	stal, tworzywo steel, plastic сталь, пластмасса	4
NM-ARTO-10-3R406-20M	406				
NM-ARTO-10-3R711-20M	711				
NM-ARTO-12-3R304-20M	304	ø12			
NM-ARTO-12-3R406-20M	406				
NM-ARTO-12-3R711-20M	711				

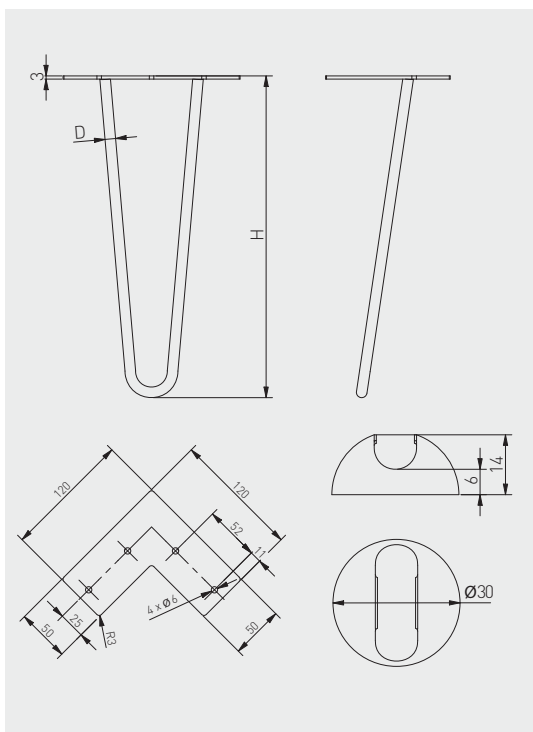

Noga ARTO – HAIRPIN
 ARTO leg – HAIRPIN
 ARTO нога – HAIRPIN

NEW



	 H mm	 ØD (mm)			
NM-ARTO-10-2R304-20M	304	Ø10	czarny mat black matt чёрный матовый	stal, tworzywo steel, plastic сталь, пластмасса	4
NM-ARTO-10-2R406-20M	406				
NM-ARTO-10-2R711-20M	711				
NM-ARTO-12-2R304-20M	304	Ø12			
NM-ARTO-12-2R406-20M	406				
NM-ARTO-12-2R711-20M	711				

Noga kwadratowa z regulacją
 Square furniture leg
 Мебельная опора с регулировкой

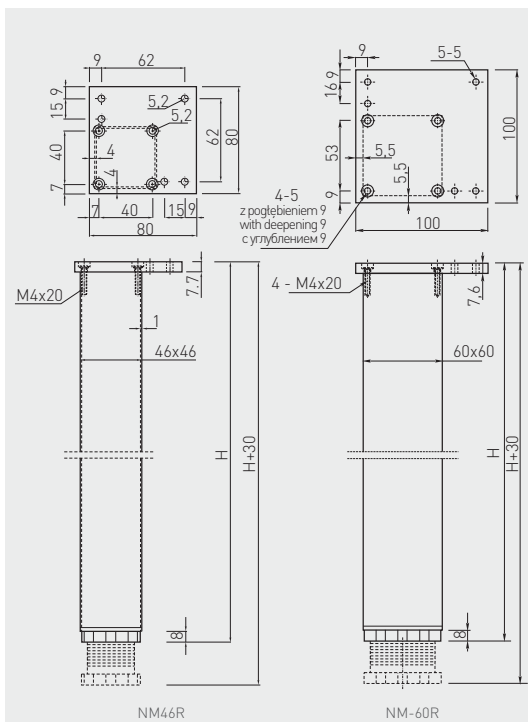
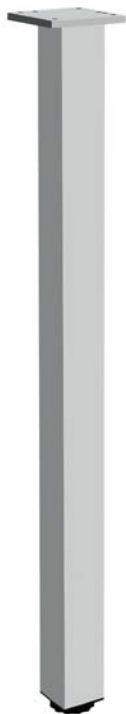

		 H mm			
NM-46R710-05		710 + 30	aluminium / aluminium / алюминий	aluminium aluminium алюминий	4
NM-46R820-05		820 + 30			
NM-60R710-05		710 + 30			
NM-60R820-05		820 + 30			
NM-60R710-06		710 + 30	stal szcztokowana / brushed steel / шлифованная сталь		
NM-60R710-20			czarny / black / чёрный		
NM-60R1100-05*		1100 + 30	aluminium / aluminium / алюминий		
NM-60R1100-20*			czarny / black / чёрный		

* Dostępna na zamówienie / Available only for individual order / Доступен под заказ

* Na indywidualne zamówienie dostępna w wysokości 1100 mm / For special orders 1100 mm height also available / Под заказ доступна также с высотой 1100 мм

Noga stelażowa INDUSTRIA
 Industria frame
 Опора для столешницы Industria

NEW

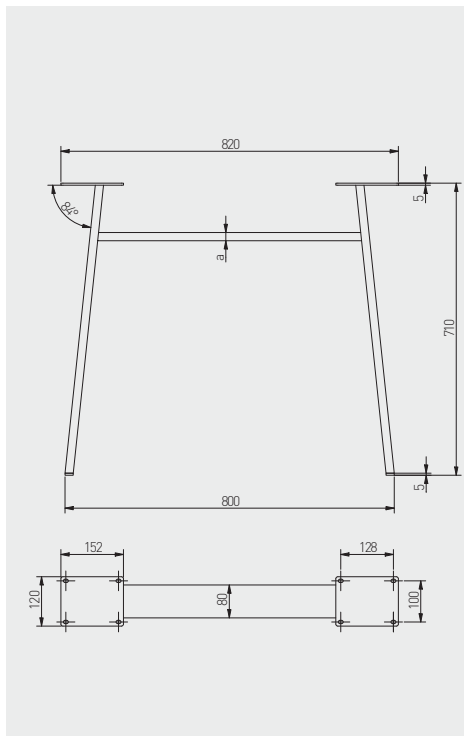

			a (mm)		
NM-INDUSTRIA-H20-710X820-20M	czarny mat / black matt / чёрный матовый		20	stal steel сталь	1
NM-INDUSTRIA-H40-710X820-20M			40		



Noga stelażowa INDUSTRIA
 Industria frame
 Опора для столешницы Industria

NEW

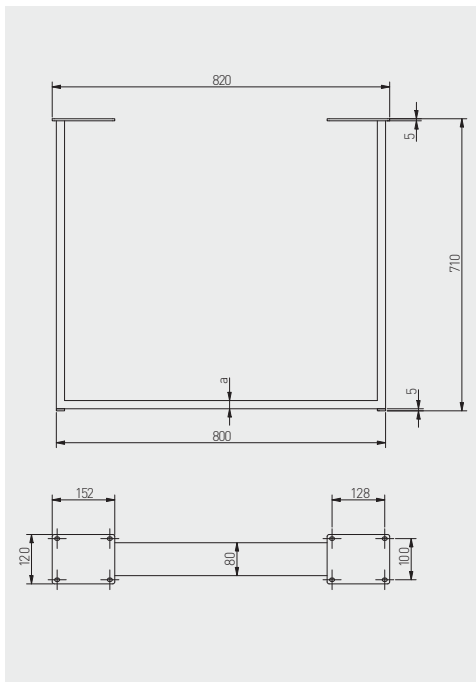

		a (mm)		
NM-INDUSTRIA-P20-710X820-20M	czarny mat / black matt / чёрный матовый	20	stal steel сталь	1
NM-INDUSTRIA-P40-710X820-20M		40		
NM-INDUSTRIA-P80-710X820-20M		80		

Noga stelażowa INDUSTRIA
 Industria frame
 Опора для столешницы Industria

NEW

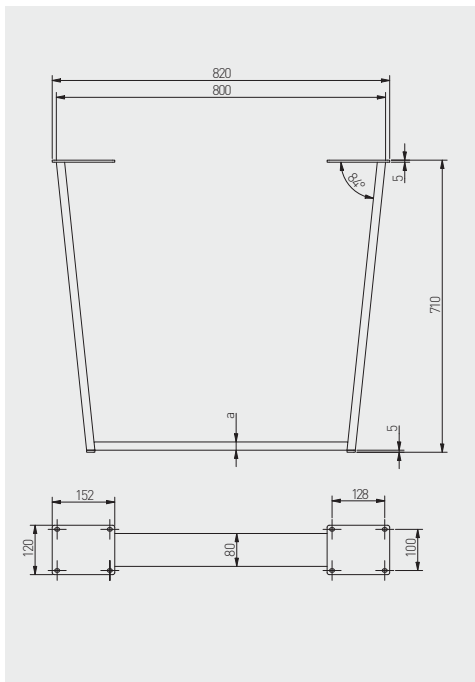

		a (mm)		
NM-INDUSTRIA-T20-710X820-20M	czarny mat / black matt / чёрный матовый	20	stal steel сталь	1
NM-INDUSTRIA-T40-710X820-20M		40		

Noga stelażowa INDUSTRIA
 Industria frame
 Опора для столешницы Industria

NEW

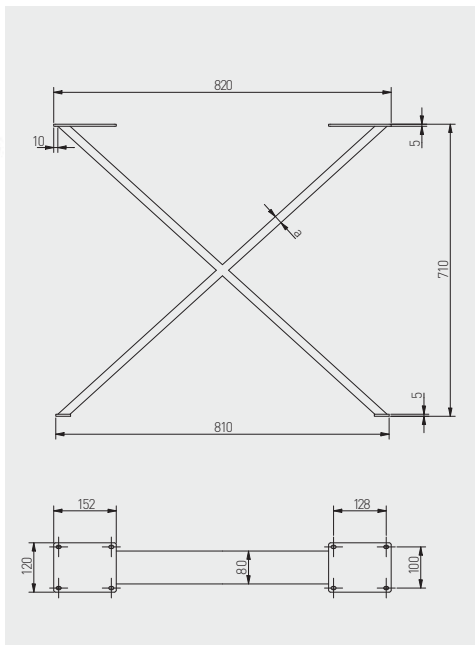

		a (mm)		
NM-INDUSTRIA-X20-710X820-20M	czarny mat / black matt / чёрный матовый	20	stal steel сталь	1
NM-INDUSTRIA-X40-710X820-20M		40		
NM-INDUSTRIA-X80-710X820-20M		80		

Noga barowa
Bar leg
Барная опора

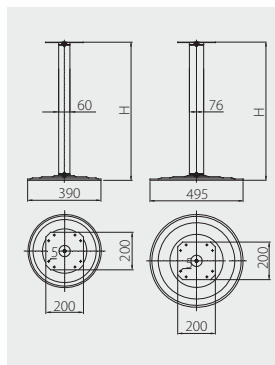

	 H mm	 Ø mm			
NM-380X730-01	735	60	chrom / chrome / хром	stal / steel / сталь	2
NM-480X730-01	735	76			



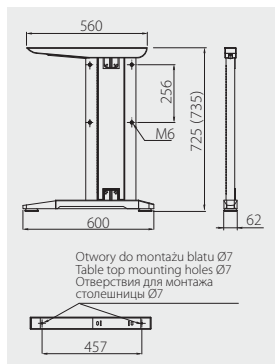



Stelaż biurkowy
Metal frames for desk
Металлический каркас для стола

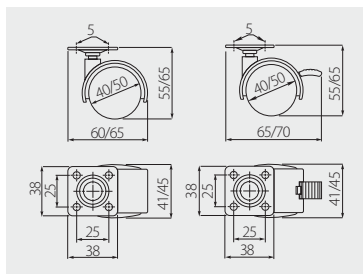

	 H mm			
SB-A60X72-80	725 (735)	srebrny / silver / серебристый	stal / steel / сталь	1





Rolka KM-D20
Furniture caster KM-D20
Колёсики KM-D20

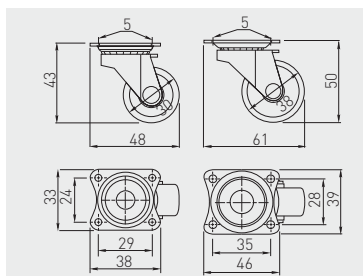

			 mm	 kg		
KM-00-40-D20		bez hamulca without break	40	18	czarny black чёрный	stal + tworzywo steel + plastic сталь + пластмасса
KM-00-50-D20		bez stopora без стопора	50	22		
KM-0H-40-D20		z hamulcem with break	40	18		
KM-0H-50-D20		so stoporem со стопором	50	22		



Rolka KM 15 plastikowa
Furniture caster KM 15 plastic
Пластиковые колёсики KM 15



		 mm	 kg		
KM-015030-10		30	13,5	biały / white / белый	stal + tworzywo steel + plastic сталь + пластмасса
KM-015030-20		30		czarny / black / чёрный	
KM-015038-10		38	16	biały / white / белый	

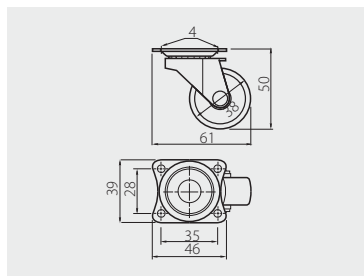





Rolka KM 15 gumowa
 Rubber furniture caster KM 15
 Резиновые колёсики KM 15

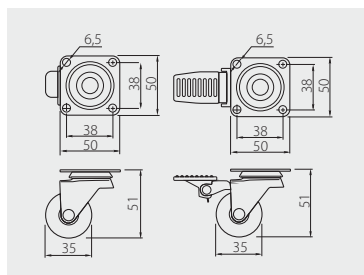

	 mm	 kg		
KM-015038-GM	38	16	czarny / black / чёрный	stal + guma steel + rubber сталь + резина





Rolka KMA 35
 Furniture caster KMA 35
 Колёсики KMA 35

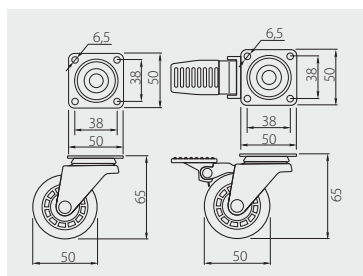

		 mm	 kg		
KM-A035MM-00	bez hamulca without break без стопора	35	25	przeźroczysty / transparent / прозрачный	PC / PU
KM-A035MM-30				brązowy / brown / коричневый	
KM-AH35MM-00	z hamulcem with break со стопором			przeźroczysty / transparent / прозрачный	
KM-AH35MM-30				brązowy / brown / коричневый	





Rolka KMA 50
Furniture caster KMA 50
Колёсики KMA 50

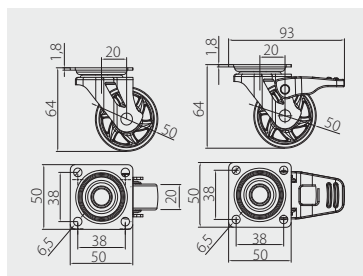

					
KM-A050MM-00	bez hamulca without break без стопора	50	35	przeźroczysty / transparent / прозрачный	PC / PU
KM-A050MM-30				brąz / brown / коричневый	
KM-AH50MM-00	z hamulcem with break со стопором			przeźroczysty / transparent / прозрачный	
KM-AH50MM-30				brąz / brown / коричневый	





Rolka SHIFT 50
Furniture caster SHIFT 50
Колёсики SHIFT 50

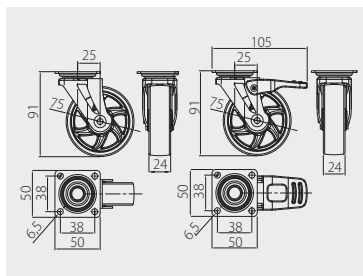

					
KM-B050MM-00	bez hamulca without break без стопора	50	30	przeźroczysty / transparent / прозрачный	PC / PU
KM-B050MM-30				brąz / brown / коричневый	
KM-BH50MM-00	z hamulcem with break со стопором			przeźroczysty / transparent / прозрачный	
KM-BH50MM-30				brąz / brown / коричневый	





Rolka SHIFT 75
Furniture caster SHIFT 75
Колёсики SHIFT 75

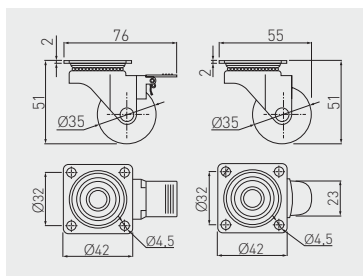

					
KM-B075MM-00	bez hamulca without break без стопора	75	40	przeźroczysty / transparent / прозрачный	PC / PU
KM-B075MM-30				brąz / brown / коричневый	
KM-BH75MM-00	z hamulcem with break со стопором			przeźroczysty / transparent / прозрачный	
KM-BH75MM-30				brąz / brown / коричневый	







Rolka BRAZYLIA 35
Furniture caster BRAZYLIA 35
Колёсики BRAZYLIA 35

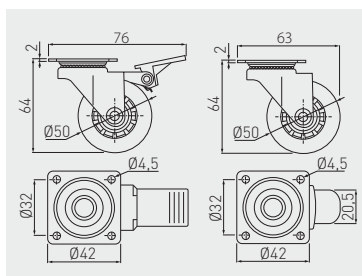

					
KM-RD-35-SF	bez hamulca without break без стопора	35	30	przeźroczysty / transparent / прозрачный	PC, PU
KM-RD-35-SF-20				czarny / black / чёрный	
KM-RD-35-CF	z hamulcem with break со стопором			przeźroczysty / transparent / прозрачный	
KM-RD-35-CF-20				czarny / black / чёрный	







Rolka BRAZYLIA 50
 Furniture caster BRAZYLIA 50
 Колёсики BRAZYLIA 50

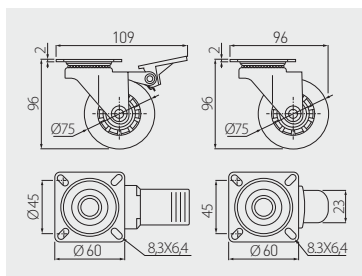

					
KM-RD-50-SF	bez hamulca without break	50	40	przeźroczysty / transparent / прозрачный	PC, PU
KM-RD-50-SF-20	bez stopora			czarny / black / чёрный	
KM-RD-50-CF	z hamulcem with break			przeźroczysty / transparent / прозрачный	
KM-RD-50-CF-20	co stoporem			czarny / black / чёрный	

Rolka BRAZYLIA 75
 Furniture caster BRAZYLIA 75
 Колёсики BRAZYLIA 75





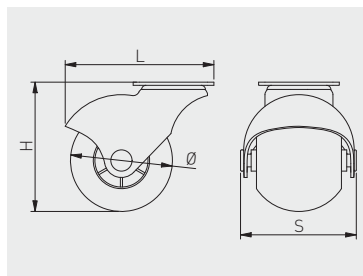

					
KM-RD-75-SF	bez hamulca without break	75	64	przeźroczysty / transparent / прозрачный	PC, PU
KM-RD-75-SF-20	bez stopora			czarny / black / чёрный	
KM-RD-75-CF	z hamulcem with break			przeźroczysty / transparent / прозрачный	
KM-RD-75-CF-20	co stoporem			czarny / black / чёрный	

Rolka SPAIN
Furniture Castor SPAIN
Мебельные ролики SPAIN

NEW







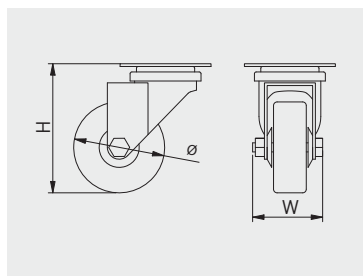

	 mm	 kg		
KM-SPAIN-40MM-18	40	15	szary, grey, серый	stal + guma steel + rubber сталь + резина
KM-SPAIN-50MM-18	50	20		

Rolka GREYROLL
Castor GREYROLL
Ролики GREYROLL

NEW



		 mm	 kg		
KM-GREYROLL-50mm-BH	bez hamulca without break без стопора	50	40	szary, grey, серый	stal + guma steel + rubber сталь + резина
KM-GREYROLL-75mm-BH		75	55		
KM-GREYROLL-50mm-ZH	z hamulcem with break со стопором	50	40		
KM-GREYROLL-75mm-ZH		75	55		

**SYSTEMY PRZESUWNE
SLIDING DOOR SYSTEMS
РАЗДВИЖНЫЕ СИСТЕМЫ**

Dolny układ jezdny
Bottom-running systems
Нижняя ходовая система

396 – 426

Górny układ jezdny
Top-running systems
Верхняя ходовая система





427 – 431



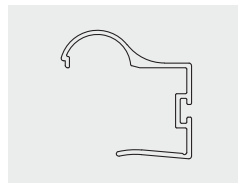

Rączka ERGO
Handle ERGO
Ручка ERGO



	 L mm		
A-R18ERG-270-05	2700	aluminium / aluminium / алюминий	aluminium aluminium алюминий
A-R18ERG-270-90		szampan / champagne / шампань	



Rączka ERGO 16
Handle ERGO 16
Ручка ERGO 16

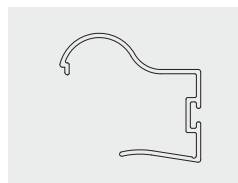

	 L mm		
A-R16ERG-220-05	2200	aluminium / aluminium / алюминий	aluminium aluminium алюминий
A-R16ERG-230-50	2300	aluminium nieanodowane / aluminum, not anodized / грязный серый	
A-R16ERG-270-50	2700	aluminium nieanodowane / aluminum, not anodized / грязный серый	
A-R16ERG-270-90	2700	szampan / champagne / шампань	



Rączka GEO 18
Handle GEO 18
Ручка GEO 18

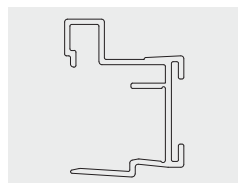





	 L mm		
A-R18GEO2-270-05	2700	aluminium / aluminium / алюминий	aluminium / aluminium / алюминий



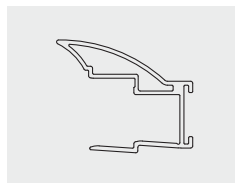

Rączka NOVO 2
Handle NOVO 2
Ручка NOVO 2



	 L mm		
A-RNOV2-270-05	2700	aluminium / aluminium / алюминий	aluminium aluminium алюминий
A-RNOV2-270-10		biały / white / белый	
A-RNOV2-270-90		szampan / champagne / шампань	



Rączka NOVO S
Handle NOVO S
Ручка NOVO S

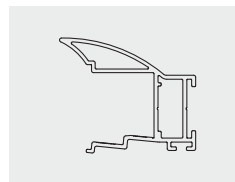

	 L mm		
A-R18NOVS-270-05	2700	aluminium / aluminium / алюминий	aluminium aluminium алюминий
A-R18NOVS-270-10		biały / white / белый	
A-R18NOVS-270-20M		czarny / black / чёрный	
A-R18NOVS-270-90		szampan / champagne / шампань	



Rączka NOVO S 19
Handle NOVO S 19
Ручка NOVO S 19

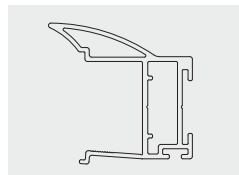





	 L mm		
A-R19NOVS-300-05	3000	aluminium / aluminium / алюминий	aluminium / aluminium / алюминий

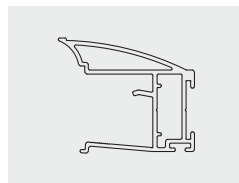

Rączka CARO
Handle CARO
Ручка CARO





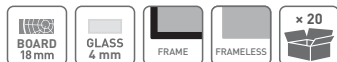

	 L mm		
A-R18CARO-270-05	2700	aluminium / aluminium / алюминий	aluminium aluminium алюминий
A-R18CARO-270-90		szampan / champagne / шампань	

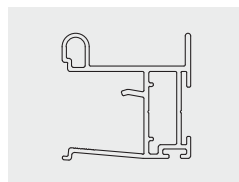

Rączka VISTA
Handle VISTA
Ручка VISTA



	 L mm		
A-R18VIS-270-05	2700	aluminium / aluminium / алюминий	aluminium aluminium алюминий
A-R18VIS-270-90		szampan / champagne / шампань	



Rączka NERO
Handle NERO
Ручка NERO

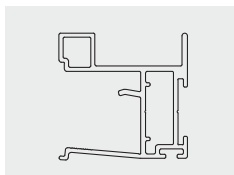

	 L mm		
A-R18NERO-270-05	2700	aluminium / aluminium / алюминий	aluminium aluminium алюминий
A-R18NERO-270-10		biały / white / белый	
A-R18NERO-270-20M		czarny / black / чёрный	
A-R18NERO-270-90		szampan / champagne / шампань	

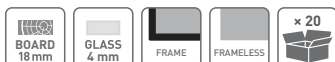

Rączka NERO 19
Handle NERO 19
Ручка NERO 19

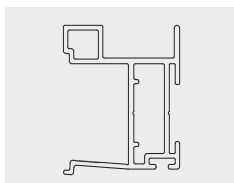



	 L mm		
A-R19NERO-300-05	3000	aluminium / aluminium / алюминий	aluminium / aluminium / алюминий

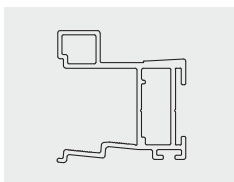

Rączka COTE
Handle COTE
Ручка COTE







	 L mm		
A-R18COTE-270-05	2700	aluminium / aluminium / алюминий	aluminium aluminium алюминий
A-R18COTE-270-90		szampan / champagne / шампань	

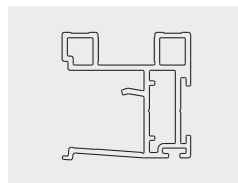

Rączka LOCA
Handle LOCA
Ручка LOCA





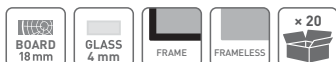

	 L mm		
A-R18LOCA-305-05	3050	aluminium / aluminium / алюминий	aluminium aluminium алюминий
A-R18LOCA-305-90		szampan / champagne / шампань	

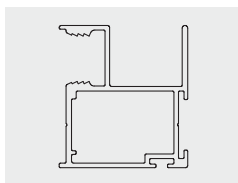

Rączka FLAT LINE
Handle FLAT LINE
Ручка FLAT LINE







	 L mm		
A-R10FL-270-05	2700	aluminium / aluminium / алюминий	aluminium aluminium алюминий
A-R10FL-270-10		biały / white / белый	
A-R10FL-270-90		szampan / champagne / шампань	

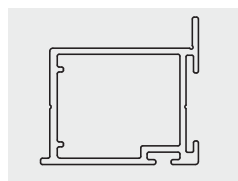

Rączka MOVENA
Handle MOVENA
Ручка MOVENA





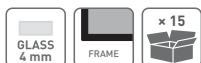

	 L mm		
A-R4MOV-270-05	2700	aluminium / aluminium / алюминий	aluminium aluminium алюминий

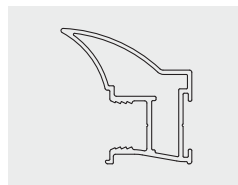

Rączka NOVO 10
Handle NOVO 10
Ручка NOVO 10



	 L mm		
A-R10NOV-270-05	2700	aluminium / aluminium / алюминий	aluminium aluminium алюминий
A-R10NOV-270-10		biały / white / белый	
A-R10NOV-270-90		szampan / champagne / шампань	



Rączka FORM
Handle FORM
Ручка FORM

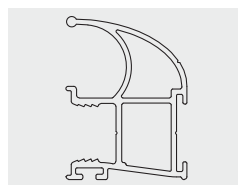

	 L mm		
A-R10FORM-270-05	2700	aluminium / aluminium / алюминий	aluminium aluminium алюминий
A-R10FORM-270-90		biały / white / белый	



Rączka TRAF0
Handle TRAF0
Ручка TRAF0

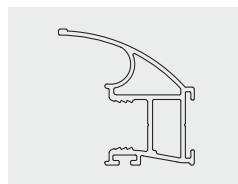

	 L mm		
A-R10TRAF0-270-05	2700	aluminium / aluminium / алюминий	aluminium aluminium алюминий
A-R10TRAF0-270-90		szampan / champagne / шампань	



Rączka TORO
Handle TORO
Ручка TORO

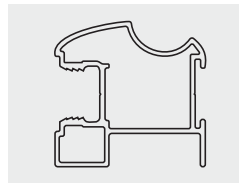

A-R10TORO-270-05	2700	aluminium / aluminium / алюминий	aluminium aluminium алюминий
A-R10TORO-270-90		szampan / champagne / шампань	



Rączka FALDA
Handle FALDA
Ручка FALDA

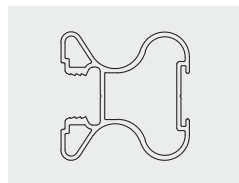

A-R10FALDA-270-05	2700	aluminium / aluminium / алюминий	aluminium aluminium алюминий
A-R10FALDA-270-90		szampan / champagne / шампань	



Rączka ARCO*
Handle ARCO*
Ручка ARCO*

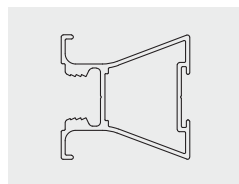







A-R10ARCO-270-05	2700	aluminium / aluminium / алюминий	aluminium aluminium алюминий
A-R10ARCO-270-90		szampan / champagne / шампань	

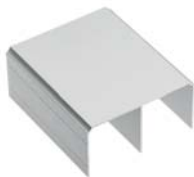

* Do wyczerpania zapasów / Until stocks run out / До исчерпания запасов

Tor górny
Top track
Верхняя направляющая



	 L mm			
A-TG-170-05	1700	aluminium / aluminium / алюминий		
A-TG-170-10		biały / white / белый		
A-TG-170-20M		czarny / black / чёрный		
A-TG-170-90		szampan / champagne / шампань		
A-TG-235-05	2350	aluminium / aluminium / алюминий		
A-TG-235-10		biały / white / белый		
A-TG-235-20M		czarny / black / чёрный		
A-TG-235-90		szampan / champagne / шампань		
A-TG-300-05	3000	aluminium / aluminium / алюминий		aluminium aluminium алюминий
A-TG-300-10		biały / white / белый		
A-TG-300-20M		czarny / black / чёрный		
A-TG-300-90		szampan / champagne / шампань		
A-TG-405-05	4050	aluminium / aluminium / алюминий		
A-TG-405-10		biały / white / белый		
A-TG-405-20M		czarny / black / чёрный		
A-TG-405-90		szampan / champagne / шампань		
A-TG-600-05	6000	aluminium / aluminium / алюминий		
A-TG-600-10		biały / white / белый		
A-TG-600-20M		czarny / black / чёрный		
A-TG-600-90		szampan / champagne / шампань		



Tor dolny EVO Bottom track EVO Нижняя направляющая EVO



			
A-TDEVO-170-05	1700	aluminium / aluminium / алюминий	aluminium aluminium алюминий
A-TDEVO-170-10		biały / white / белый	
A-TDEVO-170-20M		czarny / black / чёрный	
A-TDEVO-170-90		szampan / champagne / шампань	
A-TDEVO-235-05	2350	aluminium / aluminium / алюминий	
A-TDEVO-235-10		biały / white / белый	
A-TDEVO-235-20M		czarny / black / чёрный	
A-TDEVO-235-90		szampan / champagne / шампань	
A-TDEVO-300-05	3000	aluminium / aluminium / алюминий	
A-TDEVO-300-10		biały / white / белый	
A-TDEVO-300-20M		czarny / black / чёрный	
A-TDEVO-300-90		szampan / champagne / шампань	
A-TDEVO-405-05	4050	aluminium / aluminium / алюминий	
A-TDEVO-405-10		biały / white / белый	
A-TDEVO-405-20M		czarny / black / чёрный	
A-TDEVO-405-90		szampan / champagne / шампань	
A-TDEVO-600-05	6000	aluminium / aluminium / алюминий	
A-TDEVO-600-10		biały / white / белый	
A-TDEVO-600-20M		czarny / black / чёрный	
A-TDEVO-600-90		szampan / champagne / шампань	



Maskownica EVO Masking cover EVO Декоративная накладка



			
A-MEVO-170-05	1700	aluminium / aluminium / алюминий	aluminium aluminium алюминий
A-MEVO-170-10A		biały / white / белый	
A-MEVO-170-20M		czarny / black / чёрный	
A-MEVO-170-90		szampan / champagne / шампань	
A-MEVO-235-05	2350	aluminium / aluminium / алюминий	
A-MEVO-235-10A		biały / white / белый	
A-MEVO-235-20M		czarny / black / чёрный	
A-MEVO-235-90		szampan / champagne / шампань	
A-MEVO-300-05	3000	aluminium / aluminium / алюминий	
A-MEVO-300-10A		biały / white / белый	
A-MEVO-300-20M		czarny / black / чёрный	
A-MEVO-300-90		szampan / champagne / шампань	
A-MEVO-405-05	4050	aluminium / aluminium / алюминий	
A-MEVO-405-10		biały / white / белый	
A-MEVO-405-20M		czarny / black / чёрный	
A-MEVO-405-90		szampan / champagne / шампань	



Tor dolny EVO 2 Bottom track EVO 2 Нижняя направляющая EVO 2



	 L mm		
A-TDEVO2-170-05	1700	aluminium / aluminium / алюминий	aluminium aluminium алюминий
A-TDEVO2-170-90		szampan / champagne / шампань	
A-TDEVO2-235-05	2350	aluminium / aluminium / алюминий	
A-TDEVO2-235-90		szampan / champagne / шампань	
A-TDEVO2-300-05	3000	aluminium / aluminium / алюминий	
A-TDEVO2-300-90		szampan / champagne / шампань	
A-TDEVO2-405-05	4050	aluminium / aluminium / алюминий	
A-TDEVO2-405-90		szampan / champagne / шампань	
A-TDEVO2-600-05	6000	aluminium / aluminium / алюминий	
A-TDEVO2-600-90		szampan / champagne / шампань	



Tor dolny PRO Bottom track PRO Нижняя направляющая PRO



	 L mm		
A-TDPRO-170-05	1700	aluminium / aluminium / алюминий	aluminium aluminium алюминий
A-TDPRO-170-10		biały / white / белый	
A-TDPRO-170-20M		czarny / black / чёрный	
A-TDPRO-170-90	szampan / champagne / шампань		
A-TDPRO-235-05	2350	aluminium / aluminium / алюминий	
A-TDPRO-235-10		biały / white / белый	
A-TDPRO-235-20M		czarny / black / чёрный	
A-TDPRO-235-90	szampan / champagne / шампань		
A-TDPRO-300-05	3000	aluminium / aluminium / алюминий	
A-TDPRO-300-10		biały / white / белый	
A-TDPRO-300-20M		czarny / black / чёрный	
A-TDPRO-300-90	szampan / champagne / шампань		
A-TDPRO-405-05	4050	aluminium / aluminium / алюминий	
A-TDPRO-405-10		biały / white / белый	
A-TDPRO-405-20M		czarny / black / чёрный	
A-TDPRO-405-90	szampan / champagne / шампань		
A-TDPRO-600-05	6000	aluminium / aluminium / алюминий	
A-TDPRO-600-10		biały / white / белый	
A-TDPRO-600-20M		czarny / black / чёрный	
A-TDPRO-600-90	szampan / champagne / шампань		



Maskownica PRO Masking cover PRO Декоративная накладка PRO



	 L mm		
A-MPRO-170-05	1700	aluminium / aluminium / алюминий	aluminium aluminium алюминий
A-MPRO-170-10		biały / white / белый	
A-MPRO-170-20M		czarny / black / чёрный	
A-MPRO-170-90		szampan / champagne / шампань	
A-MPRO-235-05	2350	aluminium / aluminium / алюминий	
A-MPRO-235-10		biały / white / белый	
A-MPRO-235-20M		czarny / black / чёрный	
A-MPRO-235-90		szampan / champagne / шампань	
A-MPRO-300-05	3000	aluminium / aluminium / алюминий	
A-MPRO-300-10		biały / white / белый	
A-MPRO-300-20M		czarny / black / чёрный	
A-MPRO-300-90		szampan / champagne / шампань	
A-MPRO-405-05	4050	aluminium / aluminium / алюминий	
A-MPRO-405-10		biały / white / белый	
A-MPRO-405-20M		czarny / black / чёрный	
A-MPRO-405-90		szampan / champagne / шампань	



Listwa górna 18/4 mm Top strip 18/4 mm Профиль горизонтальный верхний 18/4 мм

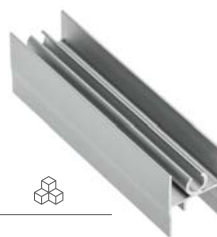

	 L mm		
A-LG18-170-05	1700	aluminium / aluminium / алюминий	aluminium aluminium алюминий
A-LG18-170-90		szampan / champagne / шампань	
A-LG18-235-05	2350	aluminium / aluminium / алюминий	
A-LG18-235-90		szampan / champagne / шампань	
A-LG18-300-05	3000	aluminium / aluminium / алюминий	
A-LG18-300-10		biały / white / белый	
A-LG18-300-20M		czarny / black / чёрный	
A-LG18-300-90		szampan / champagne / шампань	
A-LG18-405-05	4050	aluminium / aluminium / алюминий	
A-LG18-405-10		biały / white / белый	
A-LG18-405-90		szampan / champagne / шампань	
A-LG18-600-05	6000	aluminium / aluminium / алюминий	
A-LG18-600-90		szampan / champagne / шампань	



Listwa dolna 18/4 mm
Bottom strip 18/4 mm
Профиль горизонтальный нижний 18/4 мм



	 L mm		
A-LD18-170-05	1700	aluminium / aluminium / алюминий	aluminium aluminium алюминий
A-LD18-170-90		szampan / champagne / шампань	
A-LD18-235-05	2350	aluminium / aluminium / алюминий	
A-LD18-235-90		szampan / champagne / шампань	
A-LD18-300-05	3000	aluminium / aluminium / алюминий	
A-LD18-300-10		biały / white / белый	
A-LD18-300-20M		czarny / black / чёрный	
A-LD18-300-90		szampan / champagne / шампань	
A-LD18-405-05	4050	aluminium / aluminium / алюминий	
A-LD18-405-10		biały / white / белый	
A-LD18-405-90		szampan / champagne / шампань	
A-LD18-600-05	6000	aluminium / aluminium / алюминий	
A-LD18-600-90		szampan / champagne / шампань	



Listwa górna 19 mm
Top strip 19 mm
Профиль горизонтальный верхний 19 мм



	 L mm		
A-LG19-300-05	3000	aluminium aluminium алюминий	aluminium aluminium алюминий



Listwa dolna 19 mm
Bottom strip 19 mm
Профиль горизонтальный нижний 19 мм



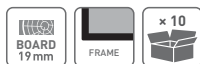

	 mm		
A-LD19-300-05	3000	aluminium aluminium алюминий	aluminium aluminium алюминий



Listwa górna 10/4 mm
Top strip 10/4 mm
Профиль горизонтальный верхний 10/4 мм







	 mm		
A-LG10-170-05	1700	aluminium / aluminium / алюминий	aluminium aluminium алюминий
A-LG10-235-05	2350	aluminium / aluminium / алюминий	
A-LG10-235-90		szampan / champagne / шампань	
A-LG10-300-05	3000	aluminium / aluminium / алюминий	
A-LG10-300-10		biały / white / белый	
A-LG10-300-90		szampan / champagne / шампань	
A-LG10-405-05	4050	aluminium / aluminium / алюминий	
A-LG10-405-90		szampan / champagne / шампань	
A-LG10-600-05	6000	aluminium / aluminium / алюминий	
A-LG10-600-90		szampan / champagne / шампань	



Listwa dolna 10/4 mm
Bottom strip 10/4 mm
Профиль горизонтальный нижний 10/4 мм







	 L mm		
A-LD10-170-05	1700	aluminium / aluminium / алюминий	aluminium aluminium алюминий
A-LD10-235-05	2350	aluminium / aluminium / алюминий	
A-LD10-235-90		szampan / champagne / шампань	
A-LD10-300-05	3000	aluminium / aluminium / алюминий	
A-LD10-300-10		biały / white / белый	
A-LD10-300-90		szampan / champagne / шампань	
A-LD10-405-05	4050	aluminium / aluminium / алюминий	
A-LD10-405-90		szampan / champagne / шампань	
A-LD10-600-05	6000	aluminium / aluminium / алюминий	
A-LD10-600-90		szampan / champagne / шампань	



Listwa górna 4 mm
Top strip 4 mm
Профиль горизонтальный верхний 4 мм







	 L mm		
A-LG4MOV-300-05	3000	aluminium / aluminium / алюминий	aluminium aluminium алюминий



Listwa dolna 4 mm
Bottom strip 4 mm
Профиль горизонтальный нижний 4 мм



	 L mm		
A-LD4MOV-300-05	3000	aluminium / aluminium / алюминий	aluminium aluminium алюминий

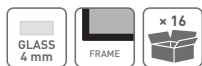

Listwa górna FL 10/4 mm
Top strip FL 10/4 mm
Профиль горизонтальный верхний FL 10/4 мм





	 L mm		
A-LG10FL-300-05	3000	aluminium / aluminium / алюминий	aluminium aluminium алюминий
A-LG10FL-300-10		biały / white / белый	
A-LG10FL-300-90		szampań / champagne / шампань	



Listwa dolna FL 10,4 mm
Bottom strip FL 10/4 mm
Профиль горизонтальный нижний FL 10/4 мм



			
A-LD10FL-300-05	3000	aluminium / aluminium / алюминий	aluminium aluminium алюминий
A-LD10FL-300-10		biały / white / белый	
A-LD10FL-300-90		szampan / champagne / шампань	



Kątownik
Angle bar
Профиль угловой



			
A-K18-300-05	3000	aluminium / aluminium / алюминий	aluminium aluminium алюминий
A-K18-300-10		biały / white / белый	
A-K18-300-20M		czarny / black / чёрный	
A-K18-300-90		szampan / champagne / шампань	



Profil C18
Profile C18
Профиль C18







			
A-C18-300-S-05	3000	aluminium / aluminium / алюминий	aluminium aluminium алюминий
A-C18-300-S-10		biały / white / белый	
A-C18-300-S-20M		czarny mat / black matt / чёрный матовый	
A-C18-300-S-90		szampan / champagne / шампань	



Profil T18
Profile T18
Профиль T18







			
A-T18-300-05	3000	aluminium / aluminium / алюминий	aluminium aluminium алюминий
A-T18-300-10		biały / white / белый	
A-T18-300-90		szampan / champagne / шампань	



Profil H16
Profile H16
Профиль H16







			
A-H16-300-05	3000	aluminium / aluminium / алюминий	aluminium aluminium алюминий
A-H16-300-90		szampan / champagne / шампань	





Profil H18
 Profile H18
 Профиль H18







	 L mm		
A-H18-300-05	3000	aluminium / aluminium / алюминий	aluminium aluminium алюминий
A-H18-300-10		biały / white / белый	
A-H18-300-20M		czarny / black / чёрный	
A-H18-300-90		szampan / champagne / шампань	



Profil H18 RA
 Profile H18 RA
 Профиль H18 RA





	 L mm		
A-HR18-300-05RA	3000	aluminium / aluminium / алюминий	aluminium aluminium алюминий
A-HR18-300-90RA		szampan / champagne / шампань	



Profil HR18
Profile HR18
Профиль HR18







	 L mm		
A-HR18-300-05	3000	aluminium / aluminium / алюминий	aluminium aluminium алюминий
A-HR18-300-10		biały / white / белый	
A-HR18-300-20M		czarny / black / чёрный	
A-HR18-300-90		szampan / champagne / шампань	



Profil HRS18
Profile HRS18
Профиль HRS18



	 L mm		
A-HRS18-170-05	1700	aluminium / aluminium / алюминий	aluminium aluminium алюминий
A-HRS18-170-90		szampan / champagne / шампань	
A-HRS18-235-05	2350	aluminium / aluminium / алюминий	
A-HRS18-235-90		szampan / champagne / шампань	
A-HRS18-300-05	3000	aluminium / aluminium / алюминий	
A-HRS18-300-90		szampan / champagne / шампань	
A-HRS18-405-05	4050	aluminium / aluminium / алюминий	
A-HRS18-405-90		szampan / champagne / шампань	
A-HRS18-600-05	6000	aluminium / aluminium / алюминий	
A-HRS18-600-90		szampan / champagne / шампань	



Profil HR19
Profile HR19
Профиль HR19







	 L mm		
A-HR19-300-05	3000	aluminium / aluminium / алюминий	aluminium / aluminium / алюминий



Profil HR10
Profile HR10
Профиль HR10







	 L mm		
A-HR10-235-05*	2350	aluminium / aluminium / алюминий	aluminium aluminium алюминий
A-HR10-235-90*		szampan / champagne / шампань	
A-HR10-300-05	3000	aluminium / aluminium / алюминий	
A-HR10-300-10		biały / white / белый	
A-HR10-300-90	4500	szampan / champagne / шампань	
A-HR10-405-05*		aluminium / aluminium / алюминий	
A-HR10-405-90*	6000	szampan / champagne / шампань	
A-HR10-600-05*		aluminium / aluminium / алюминий	
A-HR10-600-90*		szampan / champagne / шампань	

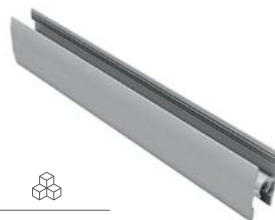

* Do wyczerpania zapasów / Until stocks run out / До исчерпания запасов

Profil HRS10
Profile HRS10
Профиль HRS10







	 L mm		
A-HRS10-170-05*	1700	aluminium / aluminium / алюминий	aluminium aluminium алюминий
A-HRS10-300-05	3000	szampan / champagne / шампань	
A-HRS10-300-90			
A-HRS10-405-05*	4050		
A-HRS10-600-05*	6000	aluminium / aluminium / алюминий	



* Do wyczerpania zapasów / Until stocks run out / До исчерпания запасов

Profil HR10 FL
Profile HR10 FL
Профиль HR10 FL





	 L mm		
A-HR10FL-300-05	3000	aluminium / aluminium / алюминий	aluminium aluminium алюминий
A-HR10FL-300-10		biały / white / белый	
A-HR10FL-300-90		szampan / champagne / шампань	



Prowadnik górny PG-18
Top roller PG-18
Верхний ролик PG-18





		
A-PG-18	50	stal, tworzywo steel, plastic сталь, пластмасса



Prowadnik górny PGR-18
Top roller PGR-18
Верхний ролик PGR-18





		
A-PGR-18	50	stal, tworzywo steel, plastic сталь, пластмасса



Prowadnik górny PGR-10
Top roller PGR-10
Верхний ролик PGR-10





		
A-PGR-10	50	stal, tworzywo steel, plastic сталь, пластмасса



Prowadnik górny PGR-10 symetryczny
 Top roller PGR-10 symmetrical
 Верхний ролик PGR-10 симметричный





		
A-PGR-10S	50	stal, tworzywo steel, plastic сталь, пластмасса



Płytk dystansowa
 Spacer plate
 Распорная пластина





		
A-DPG-16	50	stal steel сталь





Wózek dolny EVO 2
 Bottom roller EVO 2
 Нижний ролик EVO 2



		
A-WD-EV02	50	stal / tworzywo steel / plastic сталь / пластмасса





Zaczepek EVO 2
Guide EVO 2
Зацепка EVO 2

		
A-ZAC-WDEVO2	50	stal, tworzywo steel, plastic сталь, пластмасса





Wózek dolny PRO
Bottom roller PRO
Нижний ролик PRO

		
A-WD-PRO	50	stal, tworzywo steel, plastic сталь, пластмасса





Wózek dolny EVO rama
Bottom roller EVO frame
Нижний ролик EVO для рамной системы

		
A-WDR-EVO	50	stal, tworzywo steel, plastic сталь, пластмасса



Wózek dolny PRO rama
Bottom roller PRO frame
Нижний ролик PRO для рамной системы





		
A-WDR-PRO	50	stal, tworzywo steel, plastic сталь, пластмасса



Pozycjoner górny
Top positioner
Верхний стопор





		
A-PTG	50	tworzywo plastic пластмасса



Pozycjoner dolny PRO
Bottom positioner PRO
Нижний стопор PRO



		
A-PTD	50	stal steel сталь



Szczotka odbojowa 4,8 x 4
Buffer strip 4,8 x 4
Буферная щётка 4,8 x 4





		
A-SO-48X4	szary gray серый	tworzywo plastic пластмасса



Szczotka odbojowa szeroka 14,5 x 4
Buffer strip wide 14,5 x 4
Буферная щётка широкая 4,8 x 4



		
A-SO-145X4	szary / gray / серый	tworzywo plastic пластмасса
A-SO-145X4-10	biały / white / белый	
A-SO-145X4-20	czarny / black / чёрный	



Szczotka przeciwkurzowa bez kleju 4,8 x 7
Anti-dust strip without glue 4,8 x 7
Противопылевая щётка без клея 4,8 x 7



		
A-SP-48X7	szary gray серый	tworzywo plastic пластмасса



Szczotka przeciwkurzowa z klejem 7 x 12
 Anti-dust strip with glue 7 x 12
 Противопылевая щётка на клеевой основе 7 x 12



		
A-SP-7X12	szary gray серый	tworzywo plastic пластмасса



Szczotka przeciwkurzowa bez kleju 4,8 x 12
 Anti-dust strip without glue 4,8 x 12
 Противопылевая щётка 4,8 x 12 (вставная)



		
A-SP-48X12	szary gray серый	tworzywo plastic пластмасса



Klin do rączek
 Wedge for handle
 Клин для профиль-ручки



		
A-KR-4	biały white белый	tworzywo plastic пластмасса



Klin do listew poziomych
Wedge for horizontal strips
Клин для горизонтальных профилей





		
A-KLP-4	biały white белый	tworzywo plastic пластмасса



Klips do mocowania toru dolnego EVO 2
Mounting clip for bottom track EVO 2
Клипса для крепления нижней направляющей EVO 2



		
A-ZAT-TDEVO2	mleczny milk молочный	tworzywo plastic пластмасса



Uszczelka typ U, średnio twarda
Gasket U, medium hard
Уплотнитель тип U, средней твердости





			
A-USZCZ-U4	100	przeźroczysty transparent прозрачный	tworzywo plastic пластмасса



Uszczelka typ CH, miękka
Seal type CH, soft
Уплотнитель типа CH, мягкий







			
A-USZCZ-CHM4	120	przeźroczysty transparent прозрачный	tworzywo plastic пластмасса



Uszczelka do toru dolnego EVO 2
Gasket for EVO 2 track
Уплотнитель для нижней направляющей EVO 2



			
A-USZCZ-TDEV02	200	mleczny milk молочный	PVC





Błachowkręt 6,3 x 40
Steel metal screw 6,3 x 40
Сборочный винт 6,3 x 40



	
A-B63-40	stal steel сталь



Błachowkręt 6,3 x 32
Steel metal screw 6,3 x 32
Сборочный винт 6,3 x 32



	
A-B63-32*	stal steel сталь



* Do wyczerpania zapasów / Until stocks run out / До исчерпания запасов





Spowalnicz SIMON skrajny
Internal soft closing damper SIMON
Боковой доводчик SIMON

		
A-SOFT-30	30	stal, tworzywo steel, plastic сталь, пластмасса
A-SOFT-50	50	





Spowalnicz SIMON środkowy
Internal soft closing damper SIMON
Центральный доводчик SIMON

		
A-MSOFT-RAMA	50	stal, tworzywo steel, plastic сталь, пластмасса



Zestaw adaptera do spowalnicza środkowego
 Adapter set for soft closing damper
 Адаптер для доводчика

		
A-MSOFT-ADAPT	50	stal steel сталь



Zamek do systemów przesuwnych
 Lock for sliding door systems
 Замок для раздвижных систем

	
ZZ-SP-105-05	stal, tworzywo steel, plastic сталь, пластмасса



Ręczny przyrząd wiertarski z dociskiem
 Hand drilling tool with locking screws
 Ручной сверлильный кондуктор с зажимом

	
A-PW-RC-DOC	stal steel сталь



MITO
MITO
MITO

	Tor MITO Track MITO Направляющая MITO	A-TMITO-200-00	200	50	surowe aluminium raw aluminum сырой алюминий	aluminium aluminium алюминий	56
		A-TMITO-250-00	250				
		A-TMITO-300-00	300				
		A-TMITO-200-05	200		aluminium aluminium алюминий		
		A-TMITO-250-05	250				
		A-TMITO-300-05	300				
	Pozycjoner Positioner Стопор	A-POZ-MITO	-		szary gray серый	tworzywo plastic пластмасса	1000
	Wózek górny Top guide Верхний проводник	A-SG-MITO	-		ocynk zink оцинковка	stal, tworzywo steel, plastic сталь, пластмасса	100
	Wózek dolny z łożyskiem kulkowym Bottom roller with ball bearing Нижний ролик с шариковым подшипником	A-RD-MITO	-				

Zestaw MITO PLUS
MITO PLUS set
MITO PLUS комплект

2 wózki górne ze sprężyną, 2 wózki dolne z łożyskiem kulkowym, 1 pozycjoner, komplet wkrętów
 2 top rollers with spring, 2 bottom ball bearing rollers, 1 positioner, set of screws
 2 верхних проводника с пружиной, 2 нижних ролика с шариковым подшипником, 1 стопор, комплект шурупов



A-MITO-PLUS	50	ocynk / zink / оцинковка	stal / steel / сталь
-------------	----	--------------------------	----------------------



Zestaw OVERLINE

OVERLINE set

OVERLINE комплект



2 szt. wózków zewnętrznych, 2 szt. wózków wewnętrznych, 2 szt. pozycjonerów, 2 szt. prowadników dolnych ślizgowych drzwi zewnętrznych, 2 szt. prowadników dolnych ślizgowych drzwi wewnętrznych

2 external rollers, 2 internal rollers, 2 positioners, 2 bottom slides for external door, 2 bottom slides of internal door

Внешние ролики-2шт., внутренние ролики-2шт., нижние ходовые элементы внешней двери-2 шт., нижние ходовые элементы внутренней двери-2 шт., позиционер-2 шт

A-SN-FSET	50	ocynk / zink / оцинковка	stal, tworzywo / steel, plastic / сталь, пластмасса	10

	A-SN-R19RIV-270-05	-	aluminium aluminium алюминий	24		
	A-SN-K19-270-05	2700		48		
	A-C18-300-S-05	3000		50		
	A-SN-TG-405-00	4050	50	surowe aluminium raw aluminium сырой алюминий	stal steel сталь	80
	A-SN-TDS-405-00			aluminium aluminium алюминий	40	
	A-SN-SOFT-25	-	szary gray серый	tworzywo plastic пластмасса	100	
	A-SN-SOFT-40	-				40
	A-SN-ADSET	-	-	stal, tworzywo steel, plastic сталь, пластмасса	100	



Zestaw OVERLINE PLUS

OVERLINE PLUS set

OVERLINE PLUS комплектация



2 szt. wózków zewnętrznych, 2 szt. wózków wewnętrznych, 2 szt. prowadników dolnych tocznych drzwi zewnętrznych, 2 szt. prowadników dolnych tocznych drzwi wewnętrznych, 1 zestaw wkrętów

2 external rollers, 2 internal rollers, 2 bottom slides for external door, 2 bottom slides for internal door, screws

Составляющие: внешние ролики – 2шт., внутренние ролики – 2шт., нижние ходовые элементы внешней двери – 2 шт., нижние ходовые элементы внутренней двери – 2 шт., 1 клп. шурупов

A-SN-HSET1	50	ocynk / zink / оцинковка	stal, tworzywo / steel, plastic / сталь, пластмасса	1			
	Rączka RIVA Handle RIVA Ручка RIVA	A-SN-R19RIV-270-05	2700	-	aluminium aluminium алюминий	aluminium aluminium алюминий	24
	Profil C19 Handle C19 Ручка C19	A-SN-K19-270-05		-			48
	Profil C18 Handle C18 Ручка C18	A-C18-300-S-05	3000	-			50
	Tor górny Top track Верхняя направляющая	A-SN-TG-405-00	4050	-	surowe aluminium raw aluminium сырой алюминий	stal steel сталь	80
	Tor dolny Bottom track Нижняя направляющая	A-SN-TDT-405-00		-		aluminium aluminium алюминий	20
	Spowalniacz Soft closing damper доводчик	A-SN-SOFT-25	-	25	-	tworzywo plastic пластмасса	100
		A-SN-SOFT-40	-	40	-		
	Pozycjoner Positioner Стопор	A-SN-POZ	-	-	czarny black черный		20
	Zestaw do spowalniacza Soft closing damper set доводчик комплектация 1 szt. aktywator drzwi zewn. i 1 szt. wewn., 4 szt. adapterów, 1 zestaw wkrętów 1 pc activator outer door and 1 pc inner door, 4 pcs adapter, 1 screw set активатор внеш. двери – 1 шт., активатор внутр. двери – 1 шт., адаптер – 4 шт., 1 клп. шурупов	A-SN-ADSET	-	-	-	stal, tworzywo steel, plastic сталь, пластмасса	100

Prostownica Warped door straightener Стяжка-выпрямитель



2 szt. listwy ściągającej, 2 szt. płytki naciągającej, 4 szt. płytki dociskowej, zaślepka, tuleja pozycjonująca, klucz do regulacji
Tightening strip - 2 pcs, tensioning plate - 2 pcs, pressure plate - 4 pcs, cover cap, positioning sleeve, adjustment spanner
Планка с резьбой - 2 шт., натяжная пластина - 2 шт., прижимная пластина - 4 шт., заглушка, зажимная гильза, ключ для регулировки



A-SN-SDP-TU

50

ocynk / zink / оцинковка

stal, tworzywo / steel, plastic / сталь, пластмасса

BOARD
16-22mm

× 10



Zestaw QUANTUM

QUANTUM set

Комплект QUANTUM



2 szt. wózków, 2 szt. stoperów, 2 szt. przewodników, komplet wkrętów

Rollers – 2 pcs, stoppers – 2 pcs, guide – 2 pcs, screw set

Ролики – 2 шт., стопор – 2 шт., проводник – 2 шт., комплект шурупов

A-BUDP-SET	50	aluminium / aluminium / алюминий	stal, tworzywo / steel, plastic / сталь, пластмасса	24

<p>Tor górny Top track Верхняя направляющая</p>	A-TG-BUD-200-00	2000	50	surowe aluminium raw aluminium сырой алюминий	aluminium aluminium алюминий	15
	A-TG-BUD-300-00	3000				
<p>Uchwyt boczny Side holder Боковое крепление</p>	A-BUD-UB	-		ocynk zink оцинковка	stal steel сталь	200
<p>Uchwyt górny Top holder Верхнее крепление</p>	A-BUD-UG	-				
<p>Uchwyt maskownicy toru górnego Top track masking cover holder Держатель декоративной панели</p>	A-BUD-UM	60		aluminium aluminium алюминий	aluminium aluminium алюминий	250
<p>Uchwyt do ramy (4 szt.) Frame holder (4 pcs) Крепление плиты (4 шт.)</p>	A-BUD-UR	-		szary gray серый	stal, tworzywo steel, plastic сталь, пластмасса	100
<p>Uchwyt do płyty Board holder Держатель для плиты</p>	A-BUD-UP	-	ocynk zink оцинковка	stal steel сталь		



Zestaw LOFT
LOFT set
Комплект LOFT



2 szt. wózków, prowadnik, tor 2 m, 5 sztuk tulei dystansowych, 2 szt. odbojników, 2 szt. zabezpieczeń przed wypadnięciem drzwi, 2 szt. spawalniaczy, 2 szt. aktywatorów, komplet wkrętów i śrub

Roller – 2 pcs, slide – 1 pc, track 2 m, distance sleeve – 5 pcs, bumper 2 pcs, stopper preventing door from falling out – 2 pcs, soft closing damper – 2 pcs, activator – 2 pcs, screw set

Ролик – 2 шт., prowadnik – 1 шт., Направляющая 2 м, Амортизатор – 2 шт., блокада – 2 шт., доводчик – 2 шт., активатор – 2 шт., кпл. шурупов



A-SN-LOFT-200-20M	100	czarny / black / чёрный	stal, tworzywo / steel, plastic / сталь, пластмасса	1
-------------------	-----	-------------------------	---	---



OŚWIETLENIE MEBLOWE FURNITURE LIGHTING МЕБЕЛЬНОЕ ОСВЕЩЕНИЕ

Taśmy LED LED strips Светодиодные ленты	434 – 439
Profile LED LED profiles Профили LED	440 – 471
Oprawy LED LED fittings Светодиодные светильники	471 – 487
Akcesoria Accessories Аксессуары	488 – 519
Przedłużacze biurkowe Desk power sockets Выдвижные удлинители	520 – 530





ТаЅма LED FLASH
LED strip FLASH
Светодиодная лента FLASH



LD-3528-300-20-ZB	12 VDC 4,8 W/m	300 lm/m	● 6500 K	20	120°	60/m	5
LD-3528-300-20-NE4P			● 4000 K				
LD-3528-300-20-CB			● 3200 K				
LD-3528-300-65-ZB		280 lm/m	● 6500 K	65			
LD-3528-300-65-NE4			● 4000 K				
LD-3528-300-65-CB			● 3200 K				
LD-3528-300-20-NI	-	niebieski/ blue / синий .	20	8			
LD-3528-600-20-ZB	12 VDC 9,6 W/m	550 lm/m	● 6500 K	20		120/m	2,5
LD-3528-600-20-NE4			● 4000 K				
LD-3528-600-20-CB			● 3200 K				
LD-3528-600-65-ZB		520 lm/m	● 6500 K	65			
LD-3528-600-65-NE4			● 4000 K				
LD-3528-600-65-CB			● 3200 K				
LD-2835-300-20-ZB	12 VDC 6 W/m	750 lm/m	● 6500 K	20	8	60/m	5
LD-2835-300-20-NE4P			● 4000 K				
LD-2835-300-20-CB			● 3200 K				
LD-2835-300-65-ZB		700 lm/m	● 6500 K	65			
LD-2835-300-65-NE4			● 4000 K				
LD-2835-300-65-CB			● 3200 K				
LD-2835-600-20-ZB	12 VDC 12 W/m	1600 lm/m	● 6500 K	20	10	120/m	2,5
LD-2835-600-20-NE4			● 4000 K				
LD-2835-600-20-CB			● 3200 K				
LD-2835-600-65-ZB		1350 lm/m	● 6500 K	65			
LD-2835-600-65-NE4			● 4000 K				
LD-2835-600-65-CB			● 3200 K				





LD-2835-600-5MM-20-ZB	12 VDC 6,6 W/m	750 lm/m	● 6500 K	20	120°	5	120/m	2,5
LD-2835-600-5MM-20-NE4			● 4000 K					
LD-2835-600-5MM-20-CB			● 3200 K					
LD-2835-60-60-20-CCT	12 VDC 5 W/m	700 lm/m	● 3200 K ● 6500 K	20	120°	8	5	
LD-5050-300-20-ZB	12 VDC 14,4 W/m	900 lm/m	● 6500 K	65	120°	10	60/m	5
LD-5050-300-20-NE4			● 4000 K					
LD-5050-300-20-CB			● 3200 K					
LD-5050-300-65-ZB	12 VDC 14,4 W/m	850 lm/m	● 6500 K	65	120°	10	60/m	5
LD-5050-300-65-NE4			● 4000 K					
LD-5050-300-65-CB			● 3200 K					
LD-5630-300-20-ZB	12 VDC 16 W/m	1750 lm/m	● 6500 K	20	120°	10	60/m	5
LD-5630-300-20-NE4			● 4000 K					
LD-5630-300-20-CB			● 3200 K					
LD-5630-300-65-ZB	12 VDC 16 W/m	1700 lm/m	● 6500 K	65	120°	10	60/m	5
LD-5630-300-65-CB			● 3200 K					
LD-3014-1200-20-ZB			12 VDC 10,6 W/m					
LD-3014-1200-20-NE4	● 4000 K							
LD-3014-1200-20-CB	● 3200 K							
LD-RGB-150-20	12 VDC 7,2 W/m	-	● RGB	65	120°	10	30/m	10
LD-RGB-150-65			65					
LD-RGBW-300-20	12 VDC 17 W/m	-	● RGBW	20	120°	10	60/m	5



ТаЅма LED FLASH 24V
LED strip FLASH 24V
Светоодиодная лента FLASH 24V



LD-2835-24V-300-20-ZB	24 VDC 9,6 W/m	1100 lm/m	● 6500 K	20	120°	8 mm	60/m	10	
LD-2835-24V-300-20-NE4			● 4000 K						
LD-2835-24V-300-20-CB			● 3200 K						
LD-2835-24V-600-20-ZB	24 VDC 15,6 W/m	1900 lm/m	● 6500 K	20	120°	10 mm	120/m	5	
LD-2835-24V-600-20-NE4			● 4000 K						
LD-2835-24V-600-20-CB			● 3200 K						



ТаЅма LED FLASH 50 m
LED strip FLASH 50 m
Светоодиодная лента FLASH 50 m



LD-3528-300-20-ZB-50	12 VDC 4,8 W/m	300 lm/m	● 6500 K	20	120°	8 mm	60/m	5	
LD-3528-300-20-NE4P-50			● 4000 K						
LD-3528-300-20-CB-50			● 3200 K						
LD-3528-600-20-ZB-50	12DC 9,6W/m	550 lm/m	● 6500 K	20	120°	8 mm	120/m	2,5	
LD-3528-600-20-CB-50			● 3200 K						
LD-3528-600-20-NE4-50			● 4000 K						
LD-2835-300-20-ZB-50	12 VDC 6 W/m	750 lm/m	● 6500 K	20	120°	8 mm	60/m	5	
LD-2835-300-20-NE4P-50			● 4000 K						
LD-2835-300-20-CB-50			● 3200 K						
LD-5050-300-20-NE4-50	12DC 14,4W/m	900 lm/m	● 4000 K	20	120°	10 mm			
LD-5630-300-20-NE4-50	12DC 16W/m	1750 lm/m	● 4000 K	20	120°	10 mm			



Zestaw RGB, taśma LED 5 m, kontroler, zasilacz, pilot
 RGB-set, LED band 5 m, RGB controller, LED-transformator, remote control
 Комплект RGB, лента LED 5 м, контролер, трансформатор, пульт

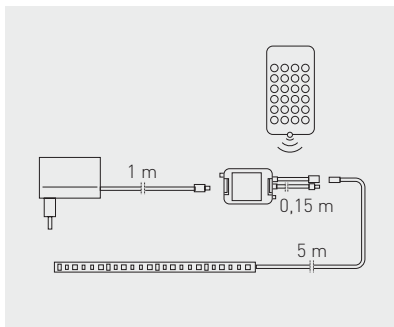

LD-ZL5RGB150-00	12V	RGB	tworzywo, plastic, пластик,	10 mm	10 cm



Zestaw RGBW, taśma LED 5 m, kontroler, zasilacz, pilot
 RGBW-set, LED band 5 m, RGB controller, LED-transformator, remote control
 Комплект RGBW, лента LED 5 м, контролер, трансформатор, пульт

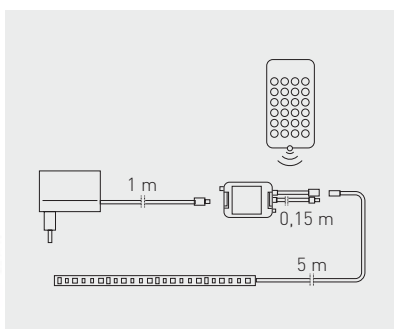

LD-ZLRGBW-300-20	12V	RGBW	tworzywo, plastic, пластик	10 mm	5 cm



Таśма LED COB
LED strip COB
Светодиодная лента COB







									
LD-COB12V-20-ZB			830 lm/m	● 6500 K					
LD-COB12V-20-NE		12 VDC 8 W/m	800 lm/m	● 4000 K	20	180°	8 mm	320/m	5
LD-COB12V-20-CB			750 lm/m	● 3200 K					



Таśма LED NEON FLEX
 LED strip NEON FLEX
 Светодиодная лента NEON FLEX



									
LD-NF12V6x12-65-ZB	12 VDC 8 W/m	200 lm/m	● 6500 K	65	120°	6 mm	100/m	2,5	
LD-NF12V6x12-65-NE			● 4000 K						
LD-NF12V6x12-65-CB			● 3200 K						



Profil GLAX liniowy
GLAX linear profile
Профиль GLAX линейный

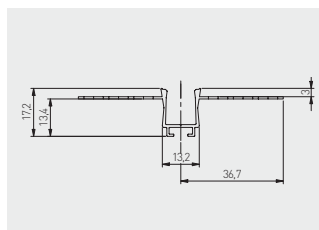

PA-GLAXGKL3M-00C	3	profil / profile / профиль	srebrny silver серебристый	aluminium aluminium алюминий
PA-CPGLAXL-00	-	łącznik liniowy connector straight лінійний з'єднувач		stal nierdzewna stainless steel нержавеющая сталь
PA-CPGLAXAH-00	-	łącznik poziomy connector horizontal горизонтальний з'єднувач		
PA-CPGLAXAV-00	-	łącznik pionowy connector vertical вертикальний з'єднувач		
PA-OSMLGLAXM3M-00	3	ostonka / cover / крышка	mleczna frosted молочная	PC
PA-OSMLGLAXMK3M-00	3	ostonka kwadratowa cover square крышка квадратная		
PA-OSMLGLAXM03M-00	3	ostonka okrągła cover round крышка круглая		
PA-OSMLGLAXT3M-00	3	ostonka trójkątna cover triangular крышка треугольная		

Ostonki / Covers / Крышки



Akcesoria / Accessories / Аксессуары



PA-CPGLAXL-00 PA-CPGLAXAH-00 PA-CPGLAXAV-00

PA-OSMLGLAXM3M-00 PA-OSMLGLAXMK3M-00 PA-OSMLGLAXM03M-00 PA-OSMLGLAXT3M-00



Profil GLAX ścienny
GLAX wall profile
Профиль GLAX настенный

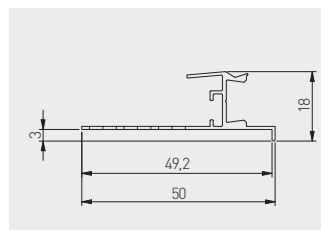

PA-GLAXGKS3M-00C	3	profil / profile / профиль	srebrny silver серебристый	aluminium aluminium алюминий
PA-CPGLAXL-00	-	łącznik liniowy connector straight лінійний з'єднувач		stal nierdzewna stainless steel нержавеющая сталь
PA-CPGLAXAH-00	-	łącznik poziomy connector horizontal горизонтальний з'єднувач		
PA-CPGLAXAV-00	-	łącznik pionowy connector vertical вертикальний з'єднувач		
PA-OSMLGLAXM3M-00	3	ostonka / cover / крышка	mleczna frosted молочная	PC
PA-OSMLGLAXMK3M-00	3	ostonka kwadratowa cover square крышка квадратная		
PA-OSMLGLAXM03M-00	3	ostonka okrągła cover round крышка круглая.		
PA-OSMLGLAXT3M-00	3	ostonka trójkątna cover triangular крышка треугольная		

Ostonki / Covers / Крышки



Aksesoria / Accessories / Аксессуары



PA-OSMLGLAXM3M-00 PA-OSMLGLAXMK3M-00 PA-OSMLGLAXM03M-00 PA-OSMLGLAXT3M-00



DO
something
(today)
THAT YOUR
FUTURE SELF
WILL
THANK YOU
for

BE
BRAVE

Better
days are
coming.
They're
called
Saturday and
Sunday.

Smile
you
are
beaut-
iful.

the
time
is
now.

DO
WHAT
YOU
LOVE.♥

A
you
is
l
BRA

Profil GLAX sufitowy
GLAX ceiling profile
Профиль GLAX потолочный

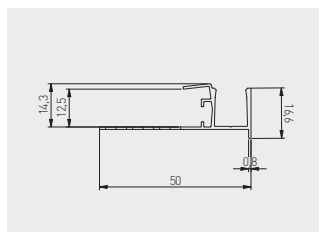
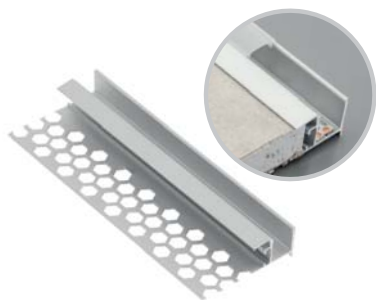

PA-GLAXGKW3M-00C	3	profil / profile / профиль	srebrny silver серебристый	aluminium aluminium алюминий
PA-CPGLAXL-00	-	łącznik liniowy connector straight лінійний з'єднувач		stal nierdzewna stainless steel нержавеющая сталь
PA-CPGLAXAH-00	-	łącznik poziomy connector horizontal горизонтальний з'єднувач		
PA-CPGLAXAV-00	-	łącznik pionowy connector vertical вертикальний з'єднувач		
PA-OSMLGLAXM3M-00	3	ostonka / cover / крышка	mleczna frosted молочная	PC
PA-OSMLGLAXMK3M-00	3	ostonka kwadratowa cover square крышка квадратная		
PA-OSMLGLAXM03M-00	3	ostonka okrągła cover round крышка круглая		
PA-OSMLGLAXT3M-00	3	ostonka trójkątna cover triangular крышка треугольная		

Ostonki / Covers / Крышки



Akcesoria / Accessories / Аксессуары



PA-CPGLAXL-00 PA-CPGLAXAH-00 PA-CPGLAXAV-00

PA-OSMLGLAXM3M-00 PA-OSMLGLAXMK3M-00 PA-OSMLGLAXM03M-00 PA-OSMLGLAXT3M-00



Profil GLAX kątowy, wewnętrzny
GLAX internal angle profile
Профиль GLAX угловой внутренний

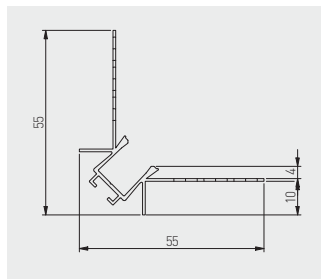

PA-GLAXGKWK3M-00C	3	profil / profile / профиль	srebrny silver серебристый	aluminium aluminium алюминий
PA-CPGLAXL-00	-	łącznik liniowy connector straight лінійний з'єднувач		
PA-CPGLAXAH-00	-	łącznik poziomy connector horizontal горизонтальний з'єднувач		
PA-CPGLAXAV-00	-	łącznik pionowy connector vertical вертикальний з'єднувач		
PA-OSMLGLAXM3M-00	3	ostonka / cover / крышка	mleczna frosted молочная	PC
PA-OSMLGLAXMK3M-00	3	ostonka kwadratowa cover square крышка квадратная		
PA-OSMLGLAXM03M-00	3	ostonka okrągła cover round крышка круглая		
PA-OSMLGLAXT3M-00	3	ostonka trójkątna cover triangular крышка треугольная		

Ostonki / Covers / Крышки



Aksesoria / Accessories / Аксессуары



PA-CPGLAXL-00 PA-CPGLAXAH-00 PA-CPGLAXAV-00

PA-OSMLGLAXM3M-00 PA-OSMLGLAXMK3M-00 PA-OSMLGLAXM03M-00 PA-OSMLGLAXT3M-00



Profil GLAX kątowy, zewnętrzny
GLAX external angle profile
Профиль GLAX угловой внешний

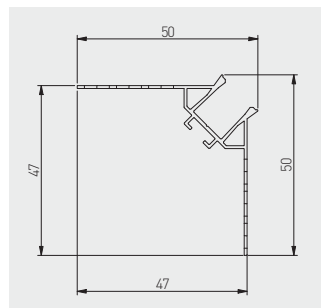
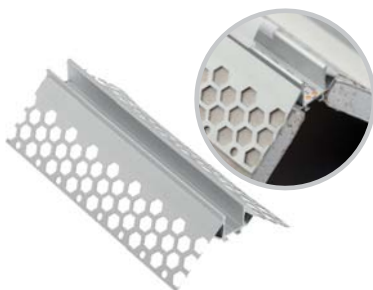

	L m	i		
PA-GLAXGKZK3M-00C	3	profil / profile / профиль	srebrny silver серебристый срібний	aluminium aluminium алюминий
PA-CPGLAXL-00	-	łącznik liniowy connector straight лінійний з'єднувач		
PA-CPGLAXAH-00	-	łącznik poziomy connector horizontal горизонтальний з'єднувач		
PA-CPGLAXAV-00	-	łącznik pionowy connector vertical вертикальний з'єднувач		
PA-OSMLGLAXM3M-00	3	ostonka / cover / крышка	mleczna frosted молочная	PC
PA-OSMLGLAXMK3M-00	3	ostonka kwadratowa cover square крышка квадратная		
PA-OSMLGLAXM03M-00	3	ostonka okrągła cover round крышка круглая		
PA-OSMLGLAXT3M-00	3	ostonka trójkątna cover triangular крышка треугольная		

Ostonki / Covers / Крышки



Aksesoria / Accessories / Аксессуары



PA-CPGLAXL-00 PA-CPGLAXAH-00 PA-CPGLAXAV-00

PA-OSMLGLAXM3M-00 PA-OSMLGLAXMK3M-00 PA-OSMLGLAXM03M-00 PA-OSMLGLAXT3M-00

Profil GLAX nakładany, mikro
 GLAX profile surface mounted, micro
 Профиль GLAX накладной, микро

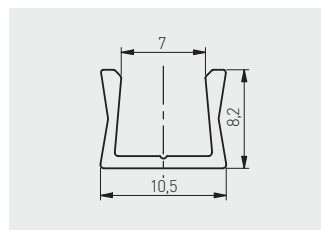
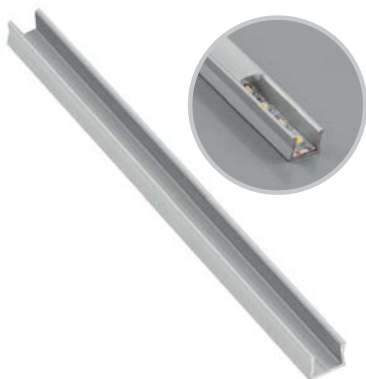

Wąska linia światła.
 Brak punktów świetlnych przy użyciu
 dedykowanej taśmy LED o szerokości 5 mm.
 Narrow line of light.
 No visible points of light due to dedicated
 5mm LED strip.
 Узкая линия света.
 Отсутствуют пункты свечения при
 использовании специальной ленты LED
 с шириной 5 мм.

	 L m			
PA-GLAXMICNK-AL	2	profil profile профиль	srebrny silver серебристый	aluminium aluminium алюминий
PA-GLAXMICNK3M-AL	3			
PA-OSMLGLAXMIC-00N	2	ostonka mikro cover micro крышка микро	mleczna frosted молочная	PC
PA-OSMLGLAXMIC3M-00N	3			
PA-ZASGLAXMICNK-00	-	zaślepka end cap заглушка	szary gray серый	ABS
PA-SPRGLAXMIC-00	-	uchwyt mounting clip держатель	srebrny silver серебристый	stal nierdzewna stainless steel нержавеющая сталь



Profil GLAX nakładany mini
 GLAX profile mini surface mounted
 Профиль GLAX накладной мини

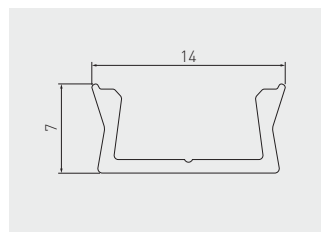

Taśma LED max. 10 mm szerokości
 LED strip width max 10 mm
 Ширина светодиодной ленты не более 10 мм



PA-GLAXMNK-AL	2	profil profile профиль	srebrny / silver / серебристый	aluminium aluminium алюминий
PA-GLAXMNK-AL-20M			czarny / black / черный	
PA-GLAXMNK-AL-10			biały / white / белый	
PA-GLAXMNK-AL-90			szampan / champagne / шампань	
PA-GLAXMNK3M-AL			srebrny / silver / серебристый	
PA-GLAXMNK3M-AL-20M	3	ostonka mini cover mini крышка мини	czarny / black / черный	PC
PA-GLAXMNK3M-AL-10			biały / white / белый	
PA-OSMLGLAXM-00			mleczna / frosted / молочная	
PA-OSMLGLAXM3M-00	3		transparentna / transparent прозрачная	
PA-OSTRGLAXM-00	2			
PA-OSTRGLAXM3M-00	3			
PA-OSMLGLAXMK-00	2	ostonka kwadratowa cover square крышка квадратная	mleczna / frosted / молочная	ABS
PA-OSMLGLAXMO-00		ostonka okrągła cover round крышка круглая		
PA-ZASGLAXMNK-00	-	zaślepka standard end cap standard заглушка стандартная	szary / gray / серый	ABS
PA-ZASGLAXMNK-10			biały / white / белый	
PA-ZASGLAXMNK-90			szampan / champagne / шампань	
PA-ZASGLAXMNK-20M			czarny mat / black matt / чёрный матовый	
PA-ZASGLAXMNKK-00	-	zaślepka kwadratowa end cap square заглушка квадратная	szary / gray / серый	
PA-ZASGLAXMNKO-00	-	zaślepka okrągła end cap round заглушка круглая	szary / gray / серый	
PA-SPRGLAXM-00	-	uchwyt mounting clip держатель	srebrny / silver / серебристый	stal nierdzewna stainless steel нержавеющая сталь

Ostonki / Covers / Крышки

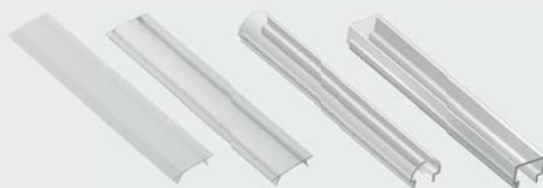
 PA-OSMLGLAXM-00
 PA-OSMLGLAXM3M-00

 PA-OSTRGLAXM-00
 PA-OSTRGLAXM3M-00

PA-OSMLGLAXMO-00

PA-OSMLGLAXMK-00

Zaślepki / End caps / Заглушки



PA-ZASGLAXMNK-00

PA-ZASGLAXMNKK-00

 Uchwyt
 mounting clip
 держатель

PA-ZASGLAXMNKO-00

PA-SPRGLAXM-00

Profil GLAX nakładany
 GLAX profile surface mounted
 Профиль GLAX накладной

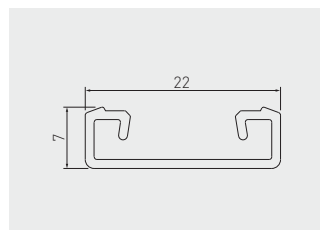

PA-GLAXNK-AL	2	profil profile профиль	srebrny silver серебристый	aluminium aluminium алюминий
PA-GLAXNK3M-AL	3			
PA-OSMLGLAX-00	2	ostonka cover крышка	mleczna frosted молочная	PC
PA-OSMLGLAX3M-00	3			
PA-OSTRGLAX-00	2		transparentna transparent прозрачная	
PA-OSTRGLAX3M-00	3			
PA-ZASGLAXNK-00	-	zaślepka end cap заглушка	szary gray серый	ABS



Profil GLAX nakładany mini, wysoki
 Profile GLAX surface mounted mini, high
 Профиль GLAX накладной мини, высокий

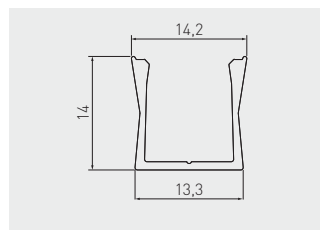

Brak widocznych punktów świetlnych.
 Taśma LED max 10 mm szerokości.
 No visible points of light.
 LED strip width max 10 mm.
 Нет видимых точек света.
 Ширина светодиодной ленты не более 10 мм.



PA-GLAXMNKW-AL	2	profil profile профиль	srebrny / silver / серебристый	aluminium aluminium алюминий
PA-GLAXMNKW-AL-20M			czarny / black / черный	
PA-GLAXMNKW-AL-10			biały / white / белый	
PA-GLAXMNKW-AL-90			szampan / champagne / шампань	
PA-OSMLGLAXM-00	2	ostonka mini cover mini крышка мини	mleczna / frosted / молочная	tworzywo plastic пластик
PA-OSTRGLAXM-00			transparentna / transparent / прозрачная	
PA-ZASGLAXMNKW-00	-	zaślepka end cap заглушка	szary / gray / серый	ABS
PA-ZASGLAXMNKW-10			biały / white / белый	
PA-ZASGLAXMNKW-90			szampan / champagne / шампань	
PA-ZASGLAXMNKW-20M			czarny mat / black matt / чёрный матовый	
PA-SPRGLAXM-00	-	uchwyt mounting clip держатель	srebrny / silver / серебристый	

Ostonki / Covers / Крышки



PA-OSMLGLAXM-00

PA-OSTRGLAXM-00

Zaślepka / End cap / Заглушка



PA-ZASGLAXMNKW-00

Uchwyt
Mounting clip
держатель



PA-SPRGLAXM-00

Profil GLAX wpuszczany, mikro
 GLAX profile recessed, micro
 Профиль GLAX врезной, микро

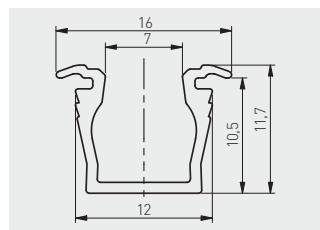

Wąska linia światła.
 Brak punktów świetlnych przy użyciu
 dedykowanej taśmy LED o szerokości 5 mm.
 Narrow line of light.
 No visible points of light due to dedicated
 5mm LED strip.
 Узкая линия света.
 Отсутствуют пункты свечения при
 использовании специальной ленты LED
 с шириной 5 мм.

				
PA-GLAXMIC-AL	2	profil profile профиль	srebrny silver серебристый	aluminium aluminium алюминий
PA-GLAXMIC3M-AL	3			
PA-OSMLGLAXMIC-00N	2	ostonka mikro cover micro крышка микро	mleczna frosted молочная	PC
PA-OSMLGLAXMIC3M-00N	3			
PA-ZASGLAXMIC-00	-	zaślepka end cap заглушка	szary gray серый	ABS

Ostonki / Covers / Крышки



PA-OSMLGLAXMIC-00N
PA-OSMLGLAXMIC3M-00N

Zaślepki / End caps / Заглушки



PA-ZASGLAXMIC-00

Profil GLAX wpuszczany
Profile GLAX recessed
Профиль LED GLAX врезной

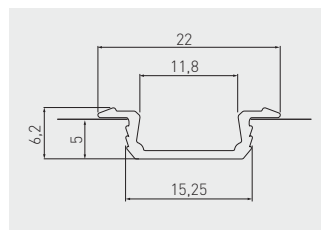

PA-GLAX-AL	2	profil profile профиль	srebrny / silver / серебристый	aluminium aluminium алюминий
PA-GLAX-AL-20M			czarny / black / черный	
PA-GLAX-AL-10			biały / white / белый	
PA-GLAX-AL-90			szampan / champagne / шампань	
PA-GLAX3M-AL	3		srebrny / silver / серебристый	
PA-OSMLGLAX-00	2	osłonka cover крышка	mleczna frosted молочная	PC
PA-OSMLGLAX3M-00	3			
PA-OSTRGLAX-00	2		transparentna transparent прозрачная	
PA-OSTRGLAX3M-00	3			
PA-ZASGLAX-00	-	zaślepka end cap заглушка	szary / gray / серый	ABS
PA-ZASGLAX-10			biały / white / белый	
PA-ZASGLAX-90			szampan / champagne / шампань	
PA-ZASGLAX-20M			czarny mat / black matt / чёрный матовый	

Ostonki / Covers / Крышки



PA-OSMLGLAXM-00
PA-OSMLGLAX3M-00

PA-OSTRGLAXM-00
PA-OSTRGLAX3M-00

Zaślepka / End cap / Заглушка

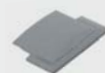

PA-ZASGLAX-00

Profil GLAX wpuszczany, wysoki
 Profile GLAX recessed, high
 Профиль LED GLAX врезной

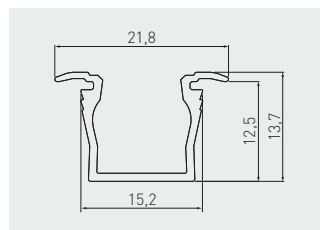

Brak widocznych punktów świetlnych.
 Taśma LED max. 10 mm szerokości.
 No visible points of light.
 LED strip width max 10 mm.
 Нет видимых точек света.
 Ширина светодиодной ленты
 не более 10 мм.

PA-GLAXMW-AL	2	profil profile профиль	srebrny / silver / серебристый	aluminium aluminium алюминий	
PA-GLAXMW-AL-20M			czarny / black / черный		
PA-GLAXMW-AL-10			biały / white / белый		
PA-GLAXMW-AL-90			szampan / champagne / шампань		
PA-OSMLGLAXM-00	2	osłonka mini cover mini крышка мини	mleczna frosted молочная	PC	
PA-OSMLGLAXMK-00		osłonka kwadratowa cover square крышка квадратная			
PA-OSTRGLAXM-00		osłonka mini cover mini крышка мини	transparentna transparent прозрачная		
PA-ZASGLAXMW-00	-	zaślepka standard end cap standard заглушка стандартная	szary / gray / серый	ABS	
PA-ZASGLAXMW-10			biały / white / белый		
PA-ZASGLAXMW-90			szampan / champagne / шампань		
PA-ZASGLAXMW-20M			czarny mat / black matt / чёрный матовый		
PA-ZASGLAXMWK-00	-	zaślepka kwadratowa end cap square заглушка квадратная	szary / gray / серый		

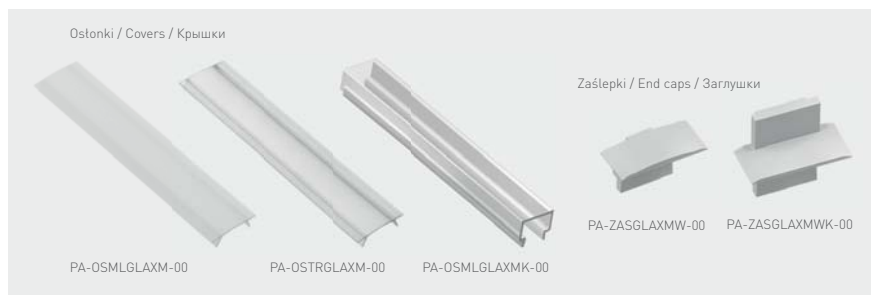

Profil GLAX drążkowy
GLAX rail profile
Профиль-штанга GLAX

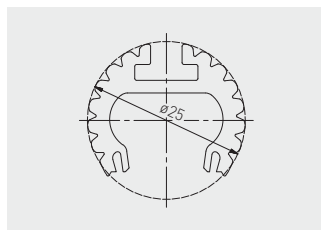

Możliwości montażu jako:

Assembly options as:

Варианты сборки:

- drążek w szafie
- rod in the closet
- sterzeń w szafie
- oprawa zwieszana
- suspended luminaire
- подвесной светильник

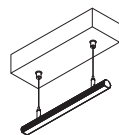
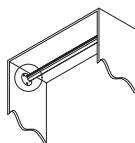

PA-GLAXDR-AL	2	profil profile профиль	srebrny silver серебристый	aluminium aluminium алюминий
PA-OSMLGLAX-00		osłonka cover крышка	mleczna frosted молочная	PC
PA-OSTRGLAX-00			transparentna transparent прозрачная	
PA-ZASGLAXDR-00	-	zaślepka end cap заглушка	szary gray серый	ABS
PA-ROZGLAX-53	-	rozetka rail socket монтажный крепеж		ZnAl
PA-ROZGLAXP-53	-	rozetka PREMIUM rail socket PREMIUM монтажный крепеж PREMIUM		
PA-ZAWGLAXDR-00	1,5	zawieszka hanger подвес для профиля	chrom chrome хром	stal steel сталь

Ostonki / Covers / Крышки



PA-OSMLGLAX-00

PA-OSTRGLAX-00

Zaślepka / End cap /
Заглушка



PA-ZASGLAXDR-00

Rozetka / Rail socket /
Монтажный крепеж



PA-ROZGLAX-53

PA-ROZGLAXP-53

Zawieszka / Hanger /
Подвес для профиля



PA-ZAWGLAXDR-00

Profil GLAX z radiatorem
Profile GLAX with heatsink
Профиль GLAX с радиатором

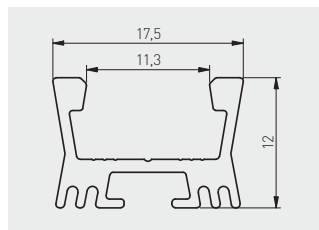

Dedykowana soczewka zawężająca kąt świecenia do 60°.
Możliwość zawieszenia oprawy za pomocą linek.
Dedicated lens that narrow the beam angle to 60°.
Possibility to suspend the fixture using lines.
Специальная линза, сужающая угол свечения до 60°.
Возможность монтажа с помощью крепления-тросика.

PA-GLAXRAD-AL	2	profil / profile / профиль	srebrny silver / серебристый	aluminium aluminium / алюминий
PA-OSMLGLAXSO-00	2	osłonka soczewka cover lenticular / крышка линзовидный	transparentna transparent / прозрачная	PMMA
PA-OSMLGLAX-00	2	osłonka cover / крышка	mleczna frosted / молочная	PC
PA-OSTRGLAX-00			transparentna transparent / прозрачная	
PA-ZASGLAXRAD-00	-	zaślepka end cap / заглушка	szary / gray / серый	ABS
PA-ZAWGLAXDR-00	1,5	zawieszka hanger / подвес для профиля	chrom chrome / хром	stal nierdzewna stainless steel / нержавеющая сталь
PA-SPRGLAXM-00	-	uchwyty mounting clip / держатель	srebrny silver / серебристый	



Profil GLAX wieńcowy
Rim profile GLAX
Профиль GLAX, торцевой

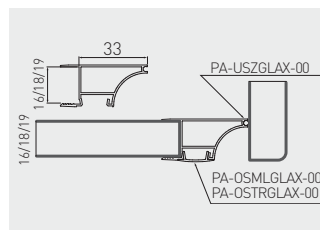

PA-GLAXWN-AL	18	3	profil, profile, профиль	srebrny, silver, серебристый	aluminium, aluminium, алюминий	
PA-GLAXWN3M-AL				czarny, black, черный		
PA-GLAXWN3M-AL-20M				biały, white, белый		
PA-GLAXWN3M-AL-10				inox, inox, шлифованная сталь.		
PA-GLAXWN3M-AL-06						
PA-GLAXWN16-AL	16	2		srebrny, silver, серебристый		
PA-GLAXWN19-AL	19					
PA-OSMLGLAX-00	-	2	ostonka, cover, крышка	mleczna, frosted, молочная	PC	
PA-OSTRGLAX-00				transparentna, transparent, прозрачная		
PA-OSMLGLAX3M-00						
PA-OSTRGLAX3M-00	-	3		mleczna, frosted, молочная		
				transparentna, transparent, прозрачная		
PA-USZGLAX-00N	-	10	uszczelka, cord gasket, уплотнитель	czarny, black, черный	EPDM	
PA-USZGLAX-10N	-			biały, white, белый		



Profil GLAX kątowy, nakładany
GLAX aluminium corner profile – surface mounted
Профиль LED GLAX угловой, накладной

meble
2019 plus
PRODUKT Roku

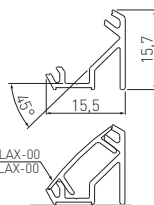

PA-OSMLGLAX-00
PA-OSTRGLAX-00

PA-GLAXNKKT-AL	2	profil profile профиль	srebrny / silver / серебристый	aluminium aluminium алюминий	
PA-GLAXNKKT-AL-20M			czarny / black / черный		
PA-GLAXNKKT-AL-10			biały / white / белый		
PA-GLAXNKKT-AL-90			szampań / champagne / шампань		
PA-GLAXNKKT3M-AL	3		srebrny / silver / серебристый		
PA-OSMLGLAX-00	2	ostonka cover крышка	mleczna frosted молочная	PC	
PA-OSMLGLAX3M-00	3		transparentna transparent прозрачная		
PA-OSTRGLAX-00	2				
PA-OSTRGLAX3M-00	3				
PA-OSMLGLAXT-00	2	ostonka trójkątna cover triangular крышка треугольная	mleczna frosted молочная		
PA-ZASGLAXNKKT-00	-	zaślepka standard end cap standard заглушка стандартная	szary / gray / серый	ABS	
PA-ZASGLAXNKKT-10			biały / white / белый		
PA-ZASGLAXNKKT-90			szampań / champagne / шампань		
PA-ZASGLAXNKKT-20M			czarny mat / black matt / чёрный матовый		
PA-ZASGLAXNKKTT-00		zaślepka trójkątna end cap triangular заглушка треугольная	szary / gray / серый		
PA-SPRGLAXMIC-00	-	uchwyt mounting clip держатель	srebrny / silver / серебристый	stal nierdzewna stainless steel нержавеющая сталь	

Ostonki / Covers / Крышки



PA-OSMLGLAX-00
PA-OSMLGLAX3M-00

PA-OSTRGLAX-00
PA-OSTRGLAX3M-00

PA-OSMLGLAXT-00

Zaślepki / End caps / Заглушки



PA-ZASGLAXNKKTT-00

Uchwyt / Mounting clip / Держатель

PA-SPRGLAXMIC-00

PA-ZASGLAXNKKT-00

Profil GLAX cokołowy wąski, jednostronny
 Corner profile GLAX, one-sided, edge mounted
 Профиль GLAX торцевой, узкий, накладной, односторонний

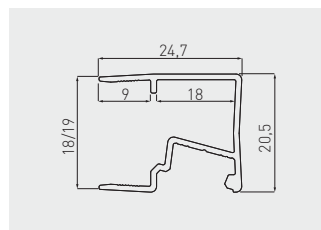

	BOARD mm	L mm			
PA-GLAXMNB JW3M-AL	18	3	profil profile профиль	srebrny silver серебристый	aluminium aluminium алюминий
PA-GLAXMNB JW3M19-AL	19				
PA-OSMLGLAXM3M-00	-		osłonka mini cover mini крышка мини	mleczna frosted молочная	PC
PA-OSTRGLAXM3M-00	-			transparentna transparent прозрачная	

Ostonki / Covers / Крышки



PA-OSMLGLAXM3M-00



PA-OSTRGLAXM3M-00

Profil GLAX cokołowy wąski, dwustronny
 Corner profile GLAX, two-sided, edge mounted
 Профиль GLAX торцевой, узкий, накладной, двусторонний

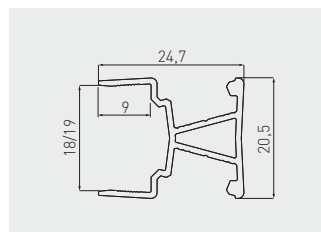

PA-GLAXMNBW3M-AL	18	3	profil profile профиль	srebrny silver серебристый	aluminium aluminium алюминий
PA-GLAXMNBW3M19-AL	19				
PA-OSMLGLAXM3M-00	-		ostonka mini cover mini крышка мини	mleczna frosted молочная	PC
PA-OSTRGLAXM3M-00	-			transparentna transparent прозрачная	

Ostonki / Covers / Крышки



PA-OSMLGLAXM3M-00







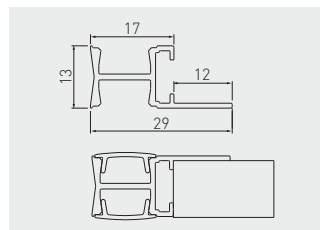

PA-OSTRGLAXM3M-00

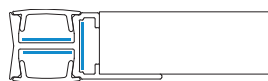
Profil GLAX półkowy mini
Shelf profile GLAX mini
Профиль GLAX полочный мини



Możliwość zastosowania 3 taśm LED.
Possibility of using 3 LED strips.
Возможность использования 3 светодиодных лент.



				
PA-GLAXMPK-AL	2	profil profile профиль	srebrny silver серебристый	aluminium aluminium алюминий
PA-OSMLGLAXM-00		osłonka mini cover mini крышка мини	mleczna frosted молочная	PC
PA-OSTRGLAXM-00		transparentna transparent прозрачная		



Profil GLAX z regulowanym kątem
 Profile GLAX with adjustable angle
 Профиль GLAX с регулировкой угла

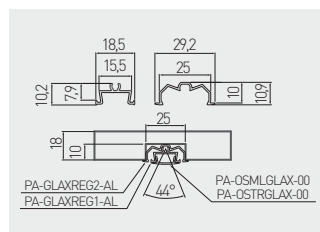

PA-GLAXREG1-AL	2	profil profile профиль	srebrny silver серебристый	aluminium aluminium алюминий
PA-GLAXREG2-AL				
PA-OSMLGLAX-00	2	ostonka cover крышка	mleczna frosted молочная	PC
PA-OSTRGLAX-00			transparentna transparent прозрачная	

Ostonki / Covers / Крышки



PA-OSMLGLAX-00



PA-OSTRGLAX-00

Profil GLAX cokołowy jednostronny
 GLAX aluminium edge profile – single-sided
 Профиль LED GLAX торцевой, односторонний

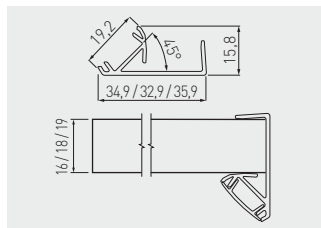

PA-GLAXNB3M16-AL	16	3	profil profile профиль	srebrny silver серебристый	aluminium aluminium алюминий
PA-GLAXNB3M-AL	18	3			
PA-GLAXNB3M19-AL	19	3			
PA-OSMLGLAX3M-00	-	3	oślonka cover крышка	mleczna frosted молочная	PC
PA-OSTRGLAX3M-00	-	3		transparentna transparent прозрачная	



Profil GLAX cokołowy jednostronny, do wypełnienia obrzeżem
 GLAX aluminium edge profile – single-sided, option to fill with matching edge banding
 Профиль LED GLAX торцевой, односторонний, кромочный, двухсторонний

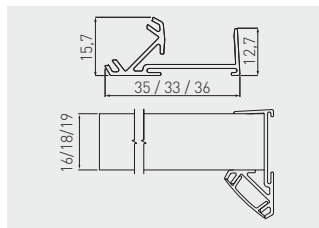

	BOARD mm	L mm			
PA-GLAXNBW3M16-AL	16	3	profil profile профиль	srebrny silver серебристый	aluminium aluminium алюминий
PA-GLAXNBW3M-AL	18	3			
PA-GLAXNBW3M19-AL	19	3			
PA-OSMLGLAX3M-00	-	3	ostonka cover крышка	mleczna frosted молочная	PC
PA-OSTRGLAX3M-00	-	3		transparentna transparent прозрачная	

Ostonki / Covers / Крышки



PA-OSMLGLAX3M-00



PA-OSTRGLAX3M-00

Profil GLAX przegrodowy dwustronny
 GLAX aluminium edge profile – double sided
 Профиль LED GLAX разделительный, двухсторонний

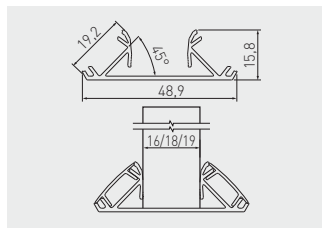

PA-GLAXNBD3M16-AL	16	3	profil profile профиль	srebrny silver серебристый	aluminium aluminium алюминий
PA-GLAXNBD3M-AL	18	3			
PA-GLAXNBD3M19-AL	19	3			
PA-OSMLGLAX3M-00	-	3	ostonka cover крышка	mleczna frosted молочная	PC
PA-OSTRGLAX3M-00	-	3		transparentna transparent прозрачная	

Ostonki / Covers / Крышки



PA-OSMLGLAX3M-00



PA-OSTRGLAX3M-00

Profil GLAX przegrodowy dwustronny, do wypełnienia obrzeżem
 GLAX aluminium edge profile – double sided, option to fill with matching edge banding
 Профиль LED GLAX разделительный, кромочный, двухсторонний

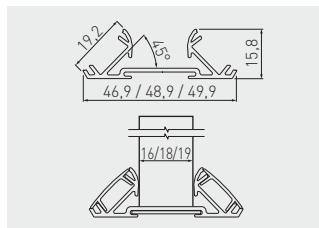

	 BOARD mm	 L mm			
PA-GLAXNBDW3M16-AL	16	3	profil profile профиль	srebrny silver серебристый	aluminium aluminium алюминий
PA-GLAXNBDW3M-AL	18	3			
PA-GLAXNBDW3M19-AL	19	3			
PA-OSMLGLAX3M-00	-	3	ostonka cover крышка	mleczna frosted молочная	PC
PA-OSTRGLAX3M-00	-			transparentna transparent прозрачная	

Ostonki / Covers / Крышки



PA-OSMLGLAX3M-00



PA-OSTRGLAX3M-00

Profil GLAX kątowy
GLAX corner profile
Профиль GLAX угловой

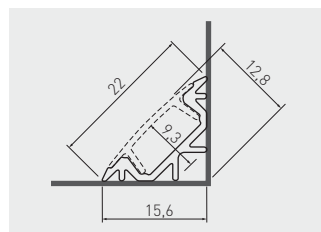

				
PA-GLAXKT-AL	2	profil profile профиль	srebrny silver серебристый	aluminium aluminium алюминий
PA-GLAXKT3M-AL	3			
PA-OSMLGLAX-00	2	ostonka cover крышка	mleczna frosted молочная	PC
PA-OSMLGLAX3M-00	3		transparentna transparent прозрачная	
PA-OSTRGLAX-00	3			
PA-OSTRGLAX3M-00	2			
PA-ZASGLAXKT-00	-	zaślepka end cap заглушка	szary gray серый	ABS



Profil GLAX kątowy, wpuszczany
 Recessed corner profile GLAX
 Профиль GLAX угловой, врезной

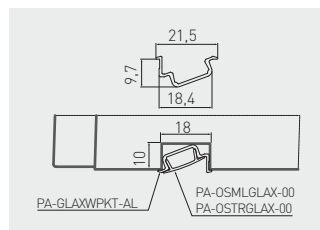

Kąt świecenia 22°
 Beam angle 22°
 Угол свечения 22°

PA-GLAXWPKT-AL	2	profil profile профиль	srebrny silver серебристый	aluminium aluminium алюминий
PA-OSMLGLAX-00		osłonka cover крышка	mleczna frosted молочная	PC
PA-OSTRGLAX-00			transparentna transparent прозрачная	

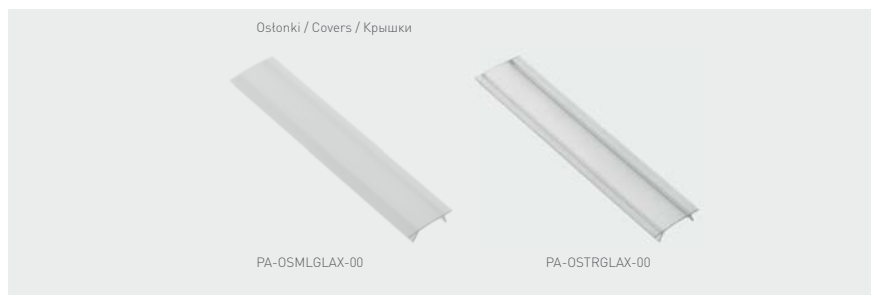



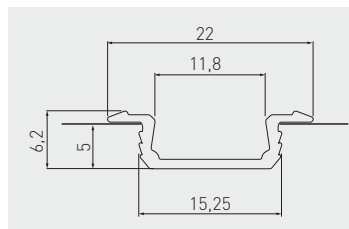

Zestaw GLAX wpuszczany
 GLAX recessed - kit
 Комплект профиль GLAX врезной

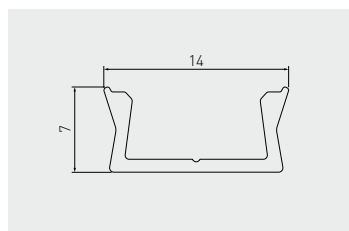

			
PA-ZGLAXOMZ-00	2	srebrny, silver, серебристый	aluminium, PC mleczne, ABS; aluminium, PC frosted, ABS; алюминий, PC молочная, ABS;

Zestaw GLAX nakładany mini
 GLAX profile mini surface mounted - kit
 Комплект профиль GLAX накладной, мини



			
PA-ZGLAXMNMKOMZ-00	2	srebrny, silver, серебристый	aluminium, PC mleczne, ABS; aluminium, PC frosted, ABS; алюминий, PC молочная, ABS;

Zestaw GLAX kątowy
GLAX corner profile - kit
Комплект профиль GLAX угловой

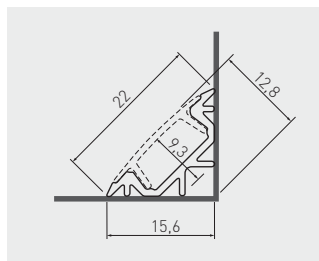

PA-ZGLAXKTMZ-00

2

srebrny, silver, серебристый

aluminium, PC mleczne, ABS;
aluminium, PC frosted, ABS;
алюминий, PC молочная, ABS;

Oprawa VASCO nakładana / wpuszczana
Fixture Vasco surface mounted / recessed
Светильник Vasco накладной / врезной

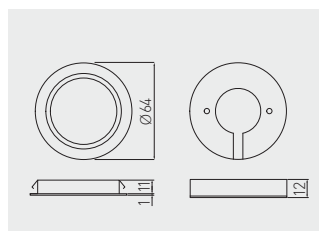

LD-VA24CB-53

3000 K

LD-VA24NE-53

4000 K

LD-VA24ZB-53

6000 K

130 lm

aluminium
aluminium
алюминий

tworzywo
plastic
пластик



Oprawa LUMINO
 Fixture LUMINO
 Светильник LUMINO

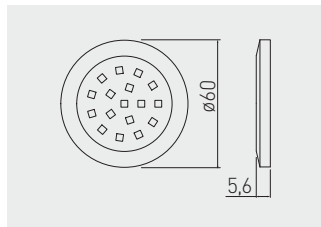

LD-LU16CB-53	70 – 85 lm	● 2700 K	aluminium aluminium алюминий	tworzywo plastic пластик
LD-LU16NE-53		● 4000 K		
LD-LU16ZB-53		● 6500 K		



Oprawa Jovita
 Fixture Jovita
 Светильник Jovita

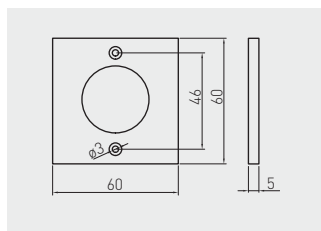

LD-KJVCOB-CB	200 lm	● 3000 K	aluminium aluminium алюминий	aluminium aluminium алюминий
LD-KJVCOB-ZB		● 6400 K		





Oprawa Jovita
 Fixture Jovita
 Светильник Jovita

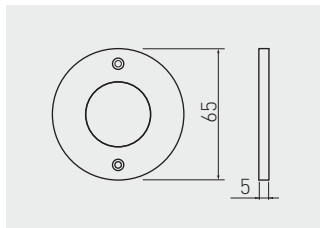

LD-OJVC0B-CB	200 lm	3000 K	aluminium aluminium алюминий	aluminium aluminium алюминий



Oprawa Jovita
 Fixture Jovita
 Светильник Jovita

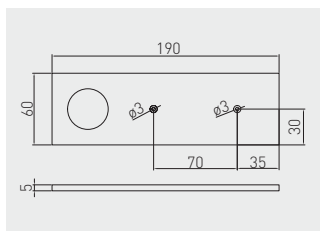

LD-PJVC0B-CB	200 lm	3000 K	aluminium aluminium алюминий	aluminium aluminium алюминий



Оправа CASTELLO z włącznikiem
 Fixture CASTELLO with switch
 Светильник CASTELLO с выключателем

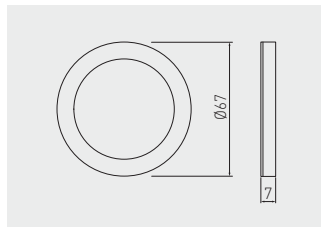

LD-CS36CB-53	180 lm	3200 K	aluminium aluminium алюминий	tworzywo plastic пластик
LD-CS36NE-53		4000 K		
LD-CS36ZB-53		6200 K		



Оправа VEGAS
 Fixture VEGAS
 Светильник VEGAS

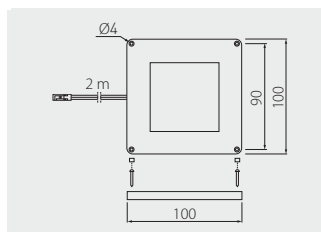

LD-VE15CB-53	140 lm	3000 K	aluminium aluminium алюминий	tworzywo / aluminium plastic / aluminium пластмасса / алюминий
LD-VE15NE-53	145 lm	4000 K		
LD-VE15ZB-53	150 lm	6400 K		



Оправа VEGAS 2 w 1
 Fixture VEGAS 2 in 1
 Светильник VEGAS 2 в 1

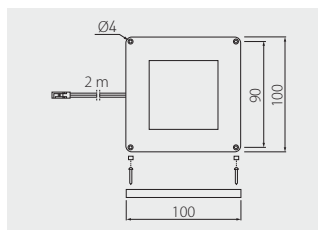

Powiązane produkty:
 Włącznik, regulator światła
 AE-WLKON-20
 Related products:
 Switch, colour temperature controller
 AE-WLKON-20



Связанных с ними продуктов:
 Выключатель, регулятор цветовой температуры
 AE-WLKON-20

LD-VE15CBZB-53	140 lm	● 3000 K - ● 6400 K	aluminium aluminium алюминий	tworzywo, aluminium plastic, aluminium пластмасса, алюминий



Оправа ALVARO wpuszczana
 Recessed fixture ALVARO
 Врезной светильник ALVARO

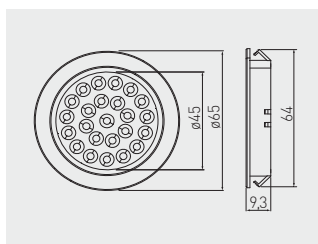

LD-AL24CB-53	130 lm	● 3000 K	aluminium aluminium алюминий	tworzywo plastic пластик
LD-AL24NE-53		● 4000 K		
LD-AL24ZB-53		● 6400 K		



Oprawa TREVI
Fixture TREVI
Светильник TREVI

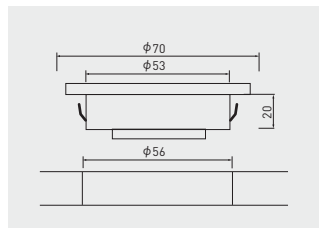

LD-TR24CB-53	300 lm	3000 K	aluminium aluminium алюминий	tworzywo plastic пластик
LD-TR24NE-53	220 lm	4000 K		
LD-TR24ZB-53	300 lm	6400 K		



Oprawa trójkątna z włącznikiem
Triangle fixture with switch
Треугольный светильник с выключателем

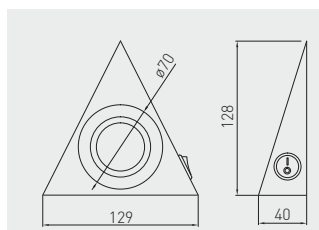

LD-OPT30S-53N	100 lm	3000 K	aluminium / aluminium / алюминий	stal steel сталь
LD-OPT60S-53N		6400 K		
LD-OPT60S-51N		6400 K	stal szczerkowana / brushed steel / шлифованная сталь	



Zestaw opraw CASTELLO z włącznikiem
 Fixture kit with switch CASTELLO
 Комплект светильников CASTELLO с выключателем

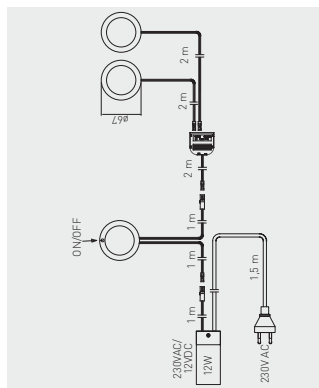

LD-Z3CSCB-53	3 x 180 lm	3000 K	aluminium / aluminium / алюминий	tworzywo / plastic / пластик



Zestaw opraw CASTELLO z włącznikiem
 Fixture kit CASTELLO with switch
 Комплект светильников CASTELLO с выключателем

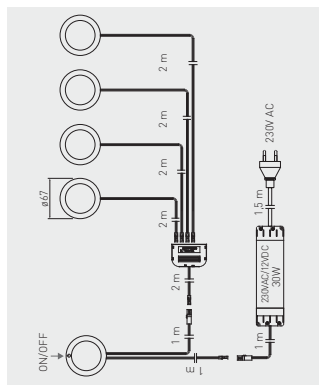

LD-Z5CSCB-53	5 x 180 lm	3000 K	aluminium / aluminium / алюминий	tworzywo / plastic / пластик



Zestaw opraw LUGO
 Fixture kit LUGO
 Комплект светильников LUGO

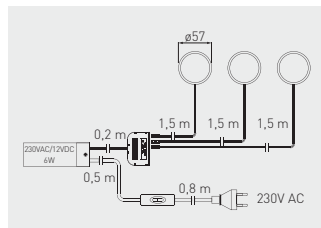

LD-LUG319-40	3 x 110 lm	● 6400 K	chrom / chrome / хром	tworzywo plastic пластик	20
LD-LCG319-52		● 3000 K	satyna / satin / сатин		20
LD-LUG319-52		● 6400 K			20



Zestaw opraw BARRI
 Fixture kit BARRI
 Комплект светильников BARRI

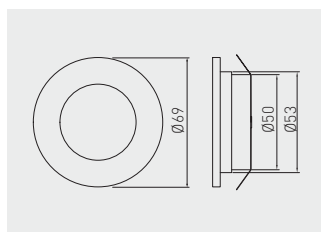

LD-OBP27CB-53	3 x 80 lm	● 2700 K	aluminium aluminium алюминий	aluminium, tworzywo aluminium, plastic алюминий, пластмасса
LD-OBP27ZB-53		● 6400 K		



Zestaw opraw MARBELLA
 Fixture kit MARBELLA
 Комплект светильников MARBELLA

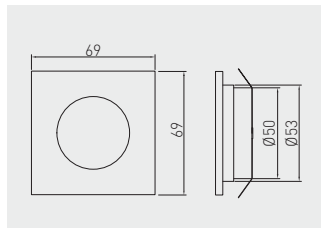

LD-KWP27CB-53	3 x 80 lm	2700 K	aluminium aluminium алюминий	aluminium, tworzywo aluminium, plastic алюминий, пластмасса
LD-KWP27ZB-53		6400 K		



Oprawa OVIEDO wpuszczana
 Recessed fixture OVIEDO
 Врезной светильник OVIEDO

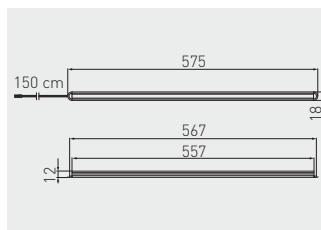





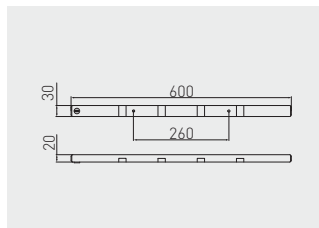

LD-WL2457-53	90 lm	6400 K	aluminium aluminium алюминий	aluminium, tworzywo aluminium, plastic алюминий, пластмасса



Oprawa FRAGA podszafkowa z włącznikiem
 Cabinet fixture with switch FRAGA
 Светильник под шкафчики FRAGA с выключателем







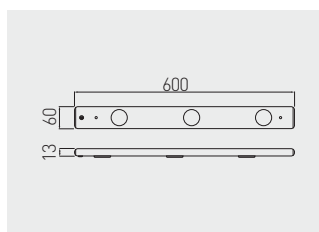

					
LD-OP408C-53	3 W	90 lm	● 6400 K	aluminium aluminium алюминий	aluminium, tworzywo aluminium, plastic алюминий, пластмасса



Oprawa ROTA podszafkowa
 Cabinet ROTA fixture
 Светильник ROTA под шкафчики



					
LD-OP456C-53	4,2 W	230 lm	● 6400 K	aluminium aluminium алюминий	aluminium, tworzywo aluminium, plastic алюминий, пластмасса
LD-OP609C-53	5,5 W	310 lm			



Оправа OPD podszafkowa
Under cabinet LED lamp fixture OPD
Светодиодный светильник OPD под шкафчик

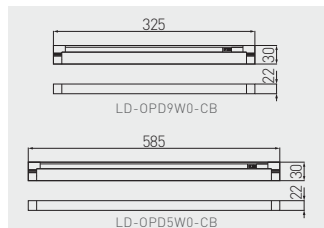

LD-OPD5W0-CB	5 W	300 lm	3000 K	chrom chrom хром	metal metal металл
LD-OPD9W0-CB	9 W	350 lm			



Оправа SORIA z czujnikiem zbliżeniowym
Fixture with proximity sensor SORIA
Светильник с датчиком приближения SORIA

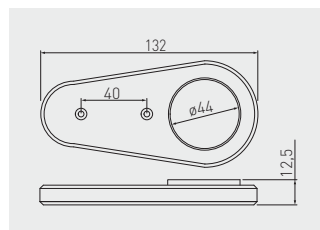

LD-SR16CB-53	90 - 110 lm	3000 K	aluminium aluminium алюминий	aluminium aluminium алюминий
LD-SR16NE-53		4000 K		
LD-SR16ZB-53		6400 K		



Oprawa RADIUS II na wysięgniku
 Fixture with arm RADIUS II
 Светильник типа „дуга” RADIUS II

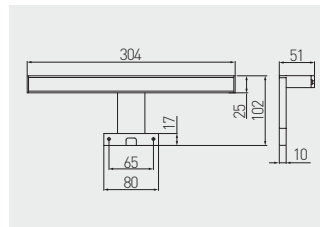

LD-RA60CB-40N	220 lm	● 3000 K	chrom chrome хром	tworzywo plastic пластмасса
LD-RA60ZB-40N		● 6400 K		



Oprawa MAXIMUS na wysięgniku
 Fixture with arm MAXIMUS
 Светильник типа „дуга” MAXIMUS

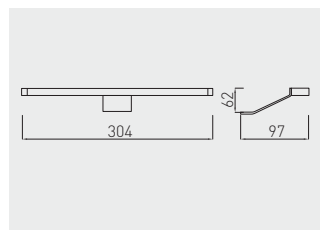

LD-MAX60CB-40N	160 lm	● 3000 K	chrom chrome хром	aluminium, tworzywo aluminium, plastic алюминий, пластмасса
LD-MAX60ZB-40N		● 6400 K		



Oprawa ABELLA na wysięgniku
 Fixture with arm ABELLA
 Светильник типа „дуга” ABELLA

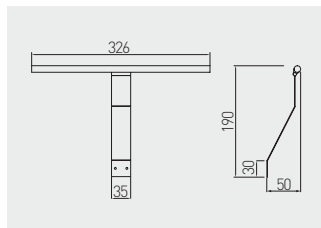

LD-AB18CB-53	460 lm	● 3000 K	aluminium aluminium алюминий	stal, aluminium, tworzywo steel, aluminium, plastic сталь, алюминий, пластмасса
LD-AB18ZB-53		● 6400 K		



Oprawa EVITA na wysięgniku
 Fixture with arm EVITA
 Светильник типа „дуга” EVITA

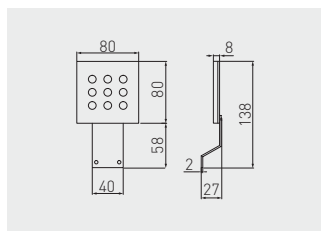

LD-EIW09CB-CZ	120 lm	● 3000 K	czarny / black / чёрный	aluminium, tworzywo aluminium, plastic алюминий, пластмасса



Оправа NOELIA на wysięgniku
 Fixture with arm NOELIA
 Светильник типа „дуга” NOELIA

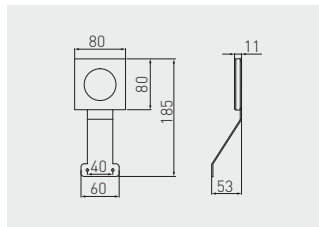

LD-NO24CB-00	330 lm	3000 K	aluminium aluminium алюминий	aluminium, tworzywo aluminium, plastic алюминий, пластмасса
LD-NO24ZB-00		6400 K		



Оправа FIDELIA на wysięgniku
 Fixture with arm FIDELIA
 Светильник типа „дуга” FIDELIA

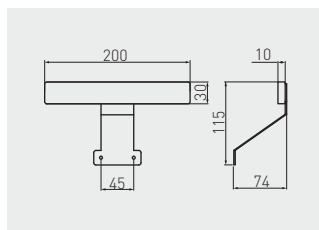

LD-FL36CB-00	155 lm	3000 K	aluminium aluminium алюминий	aluminium, tworzywo aluminium, plastic алюминий, пластмасса
LD-FL36ZB-00	165 lm	6400 K		



Oprowa CALDERON na wysięgniku
 Fixture with arm CALDERON
 Светильник типа „дуга” CALDERON

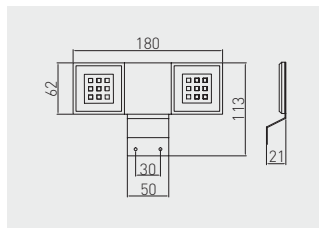

LD-NKW18CB-40	270 lm	3000 K	chrom	stal, tworzywo
LD-NKW18ZB-40		6400 K	chrome хром	steel, plastic сталь, пластмасса



Oprowa COMA bezprzewodowa
 Wireless fixture COMA
 Беспроводной светильник COMA



LD-IRUSB-53

LD-PIRUSB-53

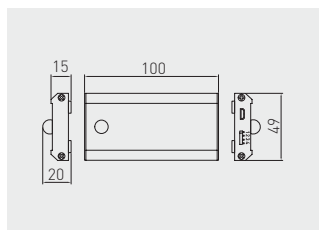

Dodatkowy przewód USB (do ładowania) – 0,5 m w komplecie
 Additional 0,5m USB cable (for charging)

Дополнительный кабель USB (для зарядки) – 0,5 m

LD-IRUSB-53	40 – 50 lm	4000 K	Czujnik zbliżeniowy IR, jedno- lub dwubiegowy Proximity sensor IR, single or double-pole Датчик движения IR, одно- и многофункциональный	aluminium aluminium алюминий	metal, tworzywo metal, plastic металл, пластик
LD-PIRUSB-53			Czujnik ruchu PIR, jednobiegowy Proximity sensor IR, single-pole Датчик движения PIR, однофункциональный		



Lampka CHICAGO z portem USB
 Bed lamp with USB CHICAGO
 Гибкая лампа с USB-разъемом CHICAGO

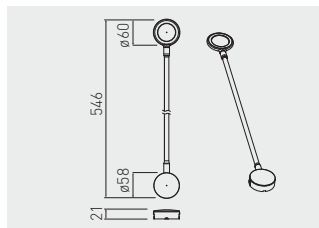

Wymaga zasilacza 12 V, 24 W
 Requires 12 V, 24 W power supply
 Требуется блок питания 12 В, 24 Вт

LD-CHIC16NE-10	120 lm	● 4000 K	biały / white / белый	stal, tworzywo steel, plastic сталь, пластмасса
LD-CHIC16NE-20			czarny / black / чёрный	



Lampka BOSTON
 Lamp BOSTON
 Лампа BOSTON

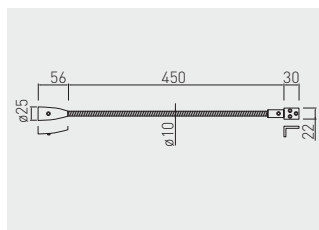

LD-BOS1CBWB-53

LD-BOS1CBWG-53

Wymaga zasilacza 12 V, 6 W
 Requires 12 V, 6 W power supply
 Требуется блок питания 12 В, 6 Вт

LD-BOS1CBWG-53	90 lm	● 3000 K	aluminium aluminium	stal, aluminium, tworzywo steel, aluminium, plastic сталь, алюминий, пластмасса
LD-BOS1CBWB-53			aluminium	



Klip plastikowy LED do półek
 Plastic LED clip for shelves
 Пластиковая клипса LED для стеклянных полок

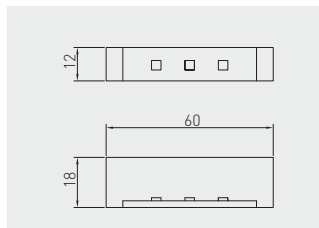

			
LD-KLPCB-00N	10 lm	● 3200 K	tworzywo plastic пластик
LD-KLPNB-00N	-	niebieski / blue / синий	
LD-KLPZB-00N	12 lm	● 6200 K	



Klip metalowy LED do półek
 Metal LED clip for shelves
 Металлическая клипса LED для стеклянных полок

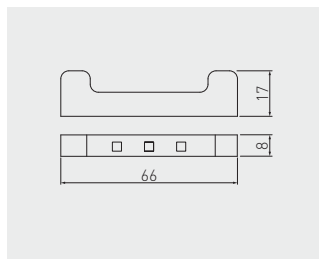

			
LD-3SKL-CBN	10 lm	● 3200 K	stal steel сталь
LD-3SKL-NBN	-	niebieski / blue / синий	
LD-3SKL-ZBN	12 lm	● 6200 K	



Mini lampka wtykowa LED
 Mini plug-in LED lamp
 Светодиодный мини-светильник в розетку

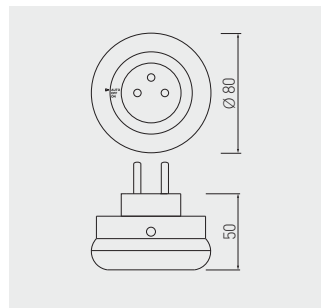

LD-ML1000-00	1 W	50 lm	4000 K	tworzywo, plastic, пластмасса	78 g



Mini lampka wtykowa LED
 Mini plug-in LED lamp
 Светодиодный мини-светильник в розетку

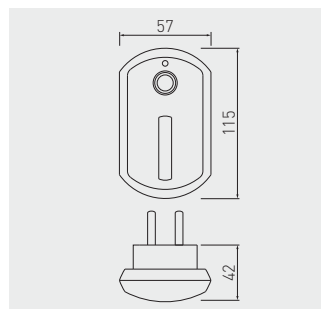

LD-ML2000-00	1 W	50 lm	4000 K	tworzywo, plastic, пластмасса	72 g



Mini lampka wtykowa LED
 Mini plug-in LED lamp
 Светодиодный мини-светильник в розетку

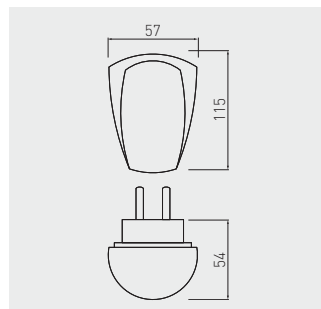

					
LD-ML3000-00	1 W	50 lm	● 4000 K	tworzywo, plastic, пластмасса	37 g



Mini lampka wtykowa LED
 Mini plug-in LED lamp
 Светодиодный мини-светильник в розетку

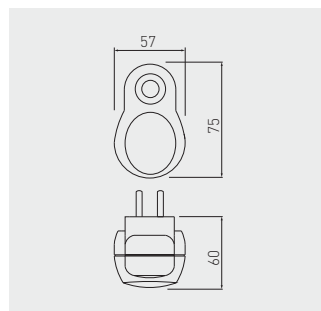

					
LD-ML4000-00	1 W	50 lm	● 4000 K	tworzywo, plastic, пластмасса	52 g



Mini lampka wtykowa LED
Mini plug-in LED lamp
Светодиодный мини-светильник в розетку

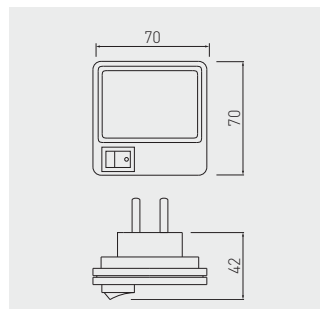

LD-ML5000-00	1 W	50 lm	4000 K	tworzywo, plastic, пластмасса	46 g



Zasilacz LED PRO
LED PRO power feeder units
Блоки питания LED PRO

NEW

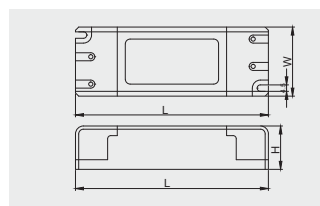

LD-ZASPRO07W-30	7 W	100 x 39 x 25 mm	tworzywo plastic пластик
LD-ZASPRO12W-30	12 W	120 x 42 x 27 mm	
LD-ZASPRO16W-30	16 W	120 x 42 x 27 mm	
LD-ZASPRO24W-30	24 W	140 x 47 x 29 mm	
LD-ZASPRO33W-30	33 W	140 x 47 x 29 mm	
LD-ZASPRO54W-30	54 W	155 x 53 x 30 mm	
LD-ZASPRO65W-30	65 W	181 x 63 x 40 mm	
LD-ZASPRO80W-30	80 W	181 x 63 x 40 mm	



Zasilacz LED
LED power supply
Светодиодный трансформатор LED

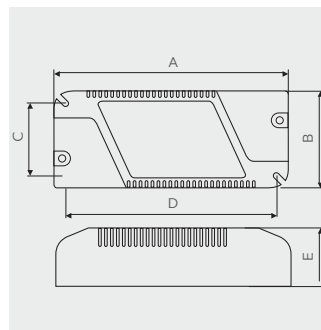





		 AxBxCxDxE mm	
LD-ZAS75W-30	max 75 W	180 x 52 x 42 x 176 x 30	tworzywo, plastic пластик

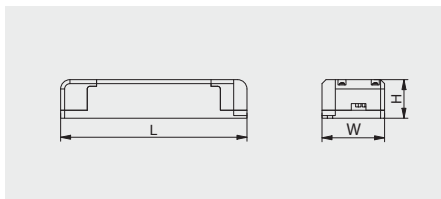

Zasilacz LED
LED power supply
Светодиодный трансформатор LED

NEW



		 LxWxH mm	
LD-ZAS24PRO80W-30	max. 80 W	181 x 63 x 40 mm	tworzywo, plastic, пластик, пластик



Układ zasilający
Power feeder set
Блок питания

NEW



LD-ZZAS07PROKD6	7 W	100 x 39 x 25	tworzywo plastic пластик
LD-ZZAS12PROKD6	12 W	120 x 42 x 27	
LD-ZZAS16PROKD6	16 W	120 x 42 x 27	
LD-ZZAS24PROKD6	24 W	140 x 47 x 29	
LD-ZZAS33PROKD6	33 W	155 x 53 x 30	

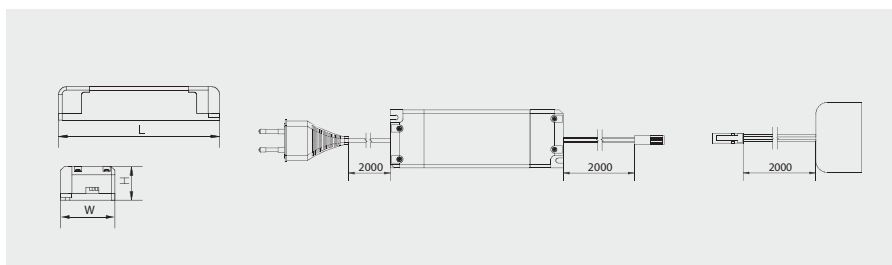

Zasilacz LED EASY CLIK
LED power supply EASY CLIK
Блок питания LED EASY CLIK

NEW

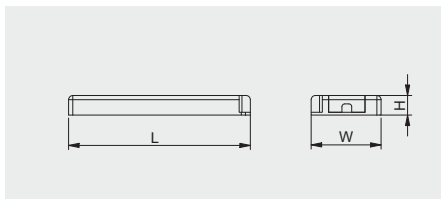

LD-ZAS09WEC-30	9 W	3 miniAMP	0,75 A	103 x 41 x 12mm	tworzywo plastic пластик	110 g
LD-ZAS15WEC-30	15 W	4 miniAMP	1,25 A	129 x 42 x 16 mm		130 g
LD-ZAS20WEC-30	20 W		1,67 A	129 x 42 x 16 mm		140 g
LD-ZAS30WEC-30	30 W	6 miniAMP	2,5 A	160 x 50 x 18 mm		190 g
LD-ZAS60WEC-30	60 W		5 A	190 x 62 x 21 mm		290 g



Zasilacz LED
Power supply
Блок питания для светодиодных светильников

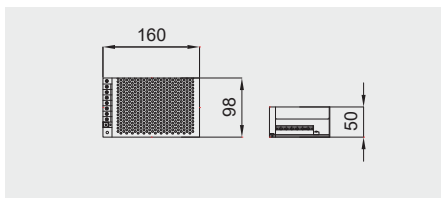

LD-ZAS150-NW	max. 150 W	aluminium aluminium алюминий



Zasilacz LED

Power supply

Блок питания для светодиодных светильников

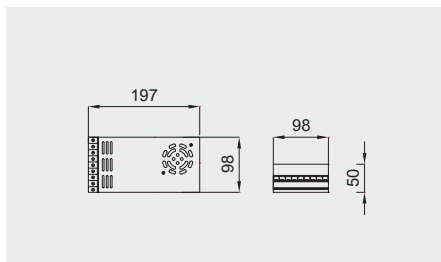

		
LD-ZAS350-NW	max. 350 W	aluminium aluminium алюминий





Zasilacz LED

Power supply

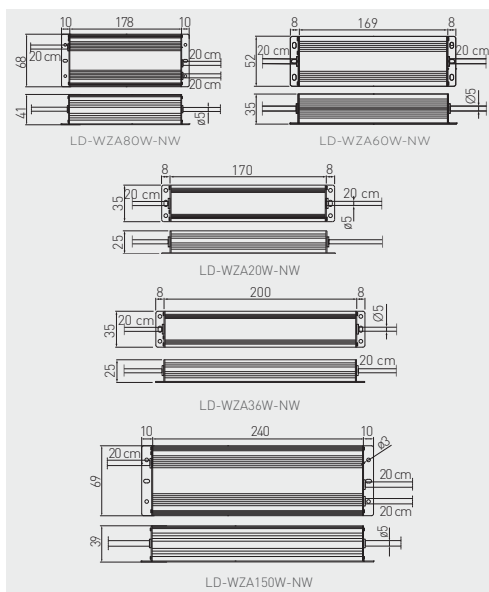
Блок питания для светодиодных светильников



		
LD-WZA20W-NW	20 W	tworzywo plastic пластик
LD-WZA36W-NW	36 W	
LD-WZA60W-NW	60 W	
LD-WZA80W-NW	80 W	
LD-WZA150W-NW	150 W	



Zasilacz LED puszkowy
LED power supply
Светодиодный трансформаторLED

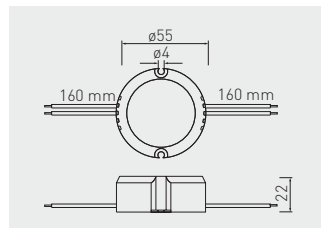

		
LD-ZASPU15W-30N	15 W	tworzywo / plastic / пластик



Układ zasilający do klipów LED 5-punktowy
Power supply set for 5 LED clips
Блок питания для светодиодных клипс, 5 разъёмов

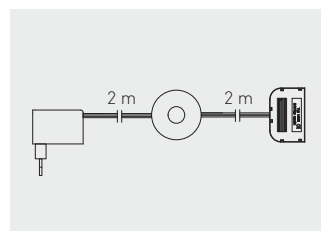



	
LD-ZSKL15-00	tworzywo / plastic / пластик

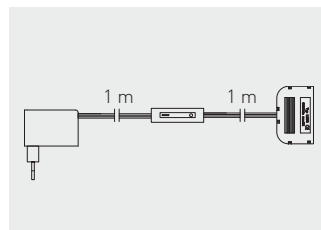

Układ zasilający
Power supply set
Блок питания



		
LD-ZWND6W-10	max. 6 W	tworzywo plastic пластик
LD-ZWND12-10	max. 12 W	



Transformator elektroniczny do żarówek halogenowych
Electronic power supply for halogen lamp
Электронный трансформатор для галогенной лампы

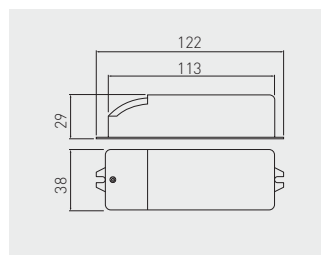

		
TE-600000-30	max. 60 W	tworzywo plastic пластик



Kontroler RGB mini z pilotem
Mini RGB controller with remote
Миниконтроллер RGB с пультом

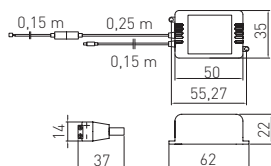

LD-KONMINI-RGB

RGB

tworzywo / plastic / пластик



Zestaw RGB – kontroler, zasilacz LED 6W, pilot i dystrybutor
RGB kit – RGB controller, power supply, remote and distributor
Комплект RGB – контроллер, трансформатор 6W, пульт, дистрибьютор

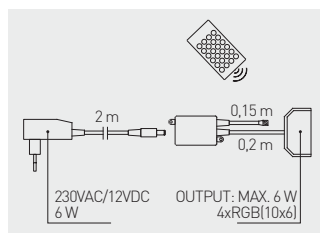

LD-ZAC6WDE-RGB

RGB



tworzywo / plastic / пластик





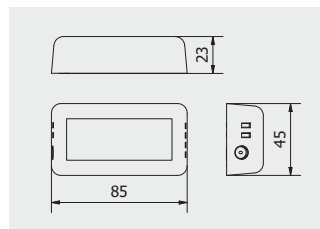







Kontroler 1-strefowy MONO
1-zone controller MONO
1-х зонный контроллер MONO



		
LD-KONML-MONO	RGB	tworzywo / plastic / пластик

								
---	---	---	---	---	---	---	---	---

Pilot 4-strefowy MONO
4-zone remote controller MONO
4-зонный пульт дистанционного управления MONO

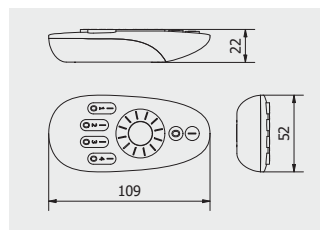

	
LD-KONML-MONO-PIL	tworzywo / plastic / пластик

					
---	---	---	---	---	---

Panel dotykowy 4-strefowy na baterie MONO
 Battery powered 4-zone touch panel MONO
 4-зонная сенсорная панель с батарейками MONO

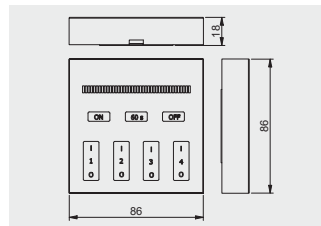

LD-KONML-MONO-PAN

tworzywo / plastic / пластик



Kontroler 1-strefowy RGBW
 1-zone controller RGBW
 1-х зонный контроллер RGBW

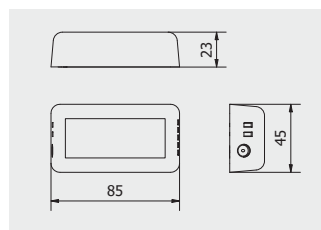

LD-KONML-RGBW



RGB

tworzywo / plastic / пластик

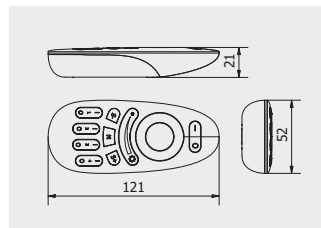

Pilot 4-strefowy RGBW
 4-zone remote controller RGBW
 4-зонный пульт дистанционного управления RGBW





		
LD-KONML-RGBW-PIL	RGB	tworzywo / plastic / пластик

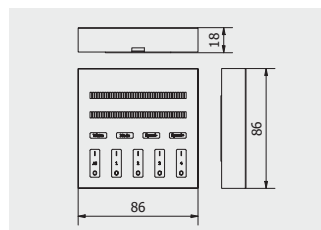

Panel dotykowy 4-strefowy na baterie RGBW
 Battery powered 4-zone touch panel RGBW
 4-зонная сенсорная панель с батарейками RGBW



		
LD-KONML-WRGB-PAN	RGB	tworzywo / plastic / пластик



Kontroler WiFi
WiFi-controller
WiFi – контроллер

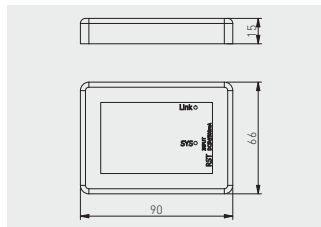

LD-KONML-WIFI

RGB

tworzywo / plastic / пластик



Adapter do pilota
Remote control adapter
Адаптер пульта дистанционного управления

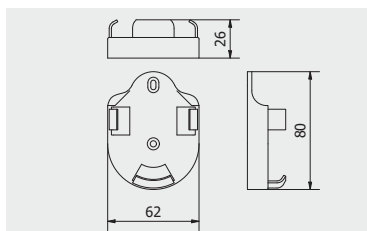

LD-KONML-AD

biały / white / белый

tworzywo / plastic / пластик





Transformator elektroniczny do żarówek halogenowych
 Electronic power supply for halogen lamp
 Электронный трансформатор для галогенной лампы

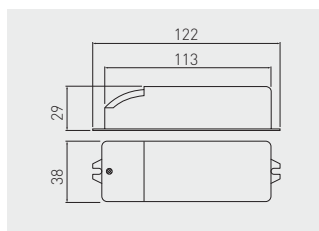

TE-600000-30	max 60 W	tworzywo / plastic / пластик



Włącznik dotykowy bezprzewodowy on-off
 Wireless touchless switch on-off
 Беспроводной сенсорный выключатель on-off

NEW

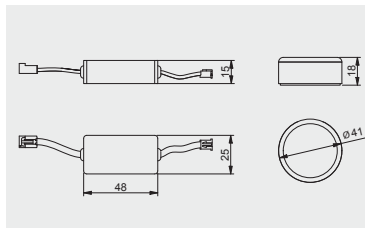

AE-WDBP1-10	biały / white / белый	tworzywo plastic пластик
AE-WDBP1-20	czarny / black / чёрный	



Włącznik dotykowy bezprzewodowy CCT
 Wireless touchless switch CCT
 Беспроводной сенсорный выключатель CCT

NEW

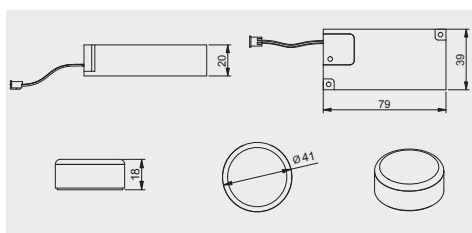

AE-WDBP2CCT-10	biały / white / белый	tworzywo plastic пластик
AE-WDBP2CCT-20	czarny / black / чёрный	



Włącznik bezdotykowy
Touchless switch
Бесконтактный датчик

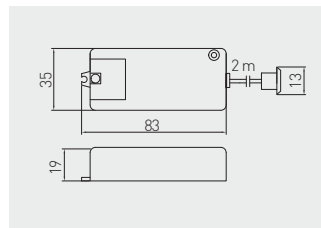

AE-WBEZDC-10S	dwubiegowy two-pole двухфункциональный	tworzywo plastic пластик
AE-WBEZDB-10S	jednobiegowy single-pole однофункциональный	



Włącznik dotykowy pod śrubę
Touch switch under screw
Сенсорный выключатель под винт

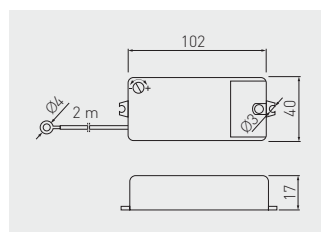

AE-WBEZDK15-10	tworzywo plastic пластмасса



Włącznik z czujnikiem ruchu PIR
Switch with PIR motion detector
Выключатель с датчиком движения PIR

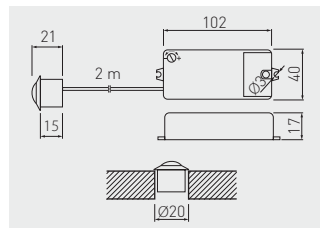

AE-WBEZDPIR-10

tworzywo
plastic
пластмасса

Włącznik z dwoma sensorami ruchu PIR II
Switch with two PIR II motion sensors
Выключатель с двумя датчиками движения PIR II

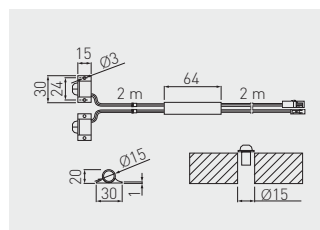

AE-WBEZDPIR2-20

tworzywo
plastic
пластмасса

Włącznik bezdotykowy uniwersalny 3 w 1
 3 in 1 all-purpose touchless switch
 Бесконтактный выключатель 3 в 1



AE-ADCUNI-10

AE-ADBUNI-10

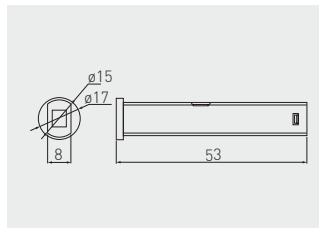

AE-WBBUNI-10DIM	biały / white / белый	tworzywo plastic пластик
AE-WBCUNI-10DIM	czarny / black / чёрный	



dimnable



Włącznik dotykowy ściemniający
 Dimmable touch switch
 Выключатель с регулятором яркости

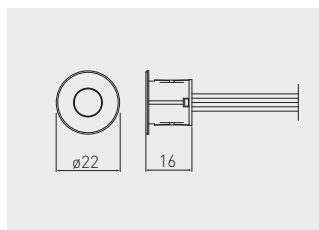

AE-WDSB-10DIM	biały / white / белый	tworzywo plastic пластик
AE-WDSC-10DIM	czarny / black / чёрный	



dimnable



Włącznik dotykowy ściemniający
Dimmable touch switch
Выключатель с регулятором яркости

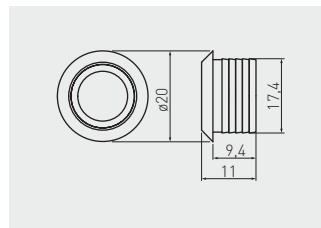

AE-WBEZD-NB	chrom chrome хром	tworzywo plastic пластик



Włącznik podblatowy
Countertop switch
Выключатель под столешницу

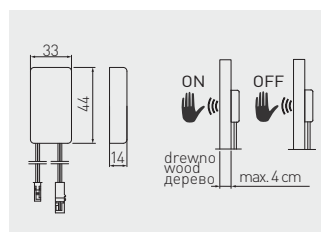

Grubość blatu max. 40 mm
Countertop thickness max. 40 mm
Толщина столешницы макс. 40 мм

AE-WPDRW-00	tworzywo / plastic / пластик



Włącznik do taśm LED montowany w profil
 Switch for LED strips mounted in profile
 Выключатель для ленты LED

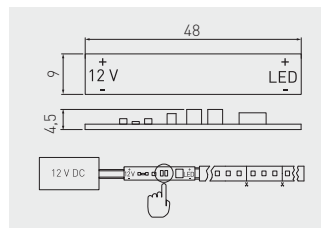

AE-WLPR-60	-	biały white белый	plytka elektroniczna circuit board электронная плата	1000
AE-WLPR-60P2	2 m			500



Włącznik kotyskowy
 Switch
 Выключатель кнопочный

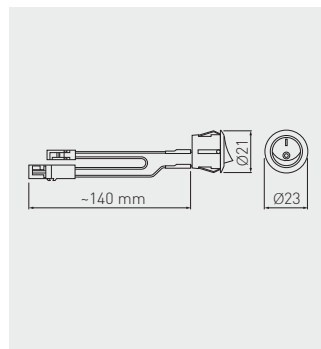

AE-WLB01-10	biały / white / белый	tworzywo plastic пластик
AE-WLC01-20	czarny / black / чёрный	



Przetącnik kotyskowy okrągły
 Round rocker switch
 Выключатель клавишный круглый



AE-WLIP44-15	biały white белый	tworzywo plastic пластмасса



Włącznik, regulator światła
 Switch, colour temperature controller
 Выключатель, регулятор цветовой температуры

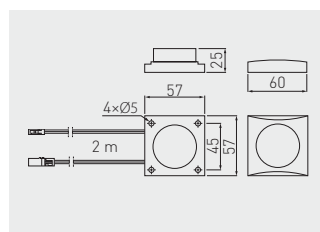

AE-WLKN-20	czarny black чёрный	tworzywo plastic пластмасса



Ściemniacz LED
LED dimmer
Светодиодный диммер

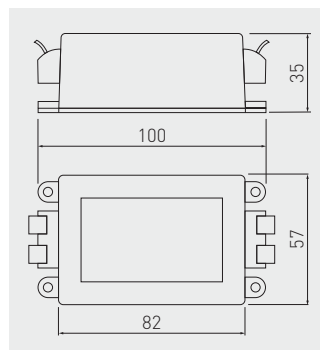

LD-DIMLED-10

czarny / black / чёрный

PC



Włącznik tańcuszkowy
Pull chain switch
Выключатель для бра и торшеров с цепочкой

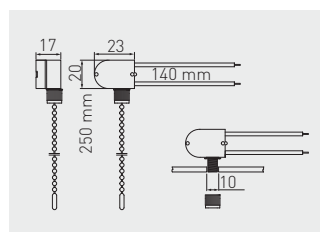

AE-WLLAN1-10

chrom / chrome / хром

tworzywo / plastic / пластик



Włącznik sznurkowy
Pull cable switch
Шнурочный выключатель



AE-WLSZN1-10

czarny / black / чёрный

polipropylen, polypropylene, полипропилен



Kabel zasilający z wtyczką i włącznikiem
Cable with plug & switch
Кабель с вилкой и выключателем

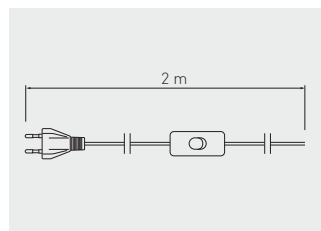

LD-KABE2M-00

biały / white / белый

tworzywo / plastic / пластик



Przewód ze złączkami mini AMP
 Cable with Mini AMP
 Кабель с соединителями мини-AMP

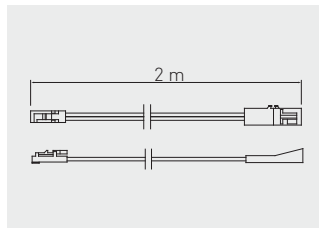

		
LZ-KAPR2M-10	czarny / black / чёрный	tworzywo / plastic / пластик



Złączka do oświetlenia ledowego z dystrybutorem, 3 gniazda
 LED lamp connector with distributor, 3 sockets
 Соединитель LED с распределителем, 3 гнезда

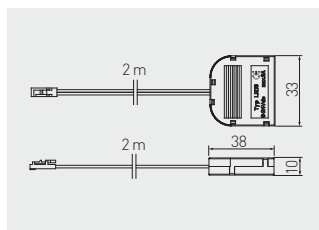

		
LZ-AKZ312-10N	czarny / black / чёрный	tworzywo / plastic / пластик



Złączka do oświetlenia ledowego z dystrybutorem, 6 gniazd
 LED lamp connector with distributor, 6 sockets
 Соединитель LED с распределителем, 6 гнезд

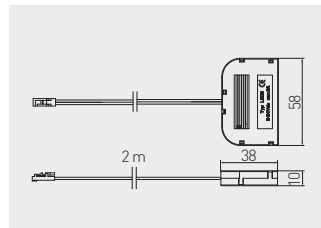

LZ-AKZ612-10N	czarny / black / чёрный	tworzywo / plastic / пластик



Złączka XC11 do taśm LED
 Connector XC11 for LED strips
 Соединитель XC11 для лент LED



LD-ZTL8MM-02N



LD-ZTL8MM-02N600



LD-ZTL10MM-02N



LD-ZTLRGB-04N

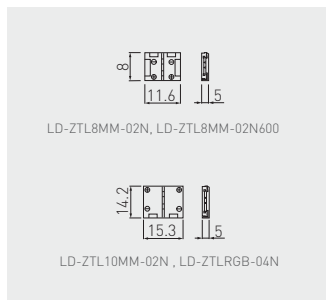

LD-ZTL8MM-02N	8 mm	tworzywo plastic пластик
LD-ZTL8MM-02N600	8 mm, 600 LED	
LD-ZTL10MM-02N	10 mm	
LD-ZTLRGB-04N	RGB	



Złącza XC11 do taśm LED kątowna
 Angular connector XC11 for LED strips
 Угловой соединитель XC11 для лент LED



LD-ZTKT8MM-02N

LD-ZTKT8MM-02N600



LD-ZTKT10MM-02N

LD-ZTKTRGB-02N

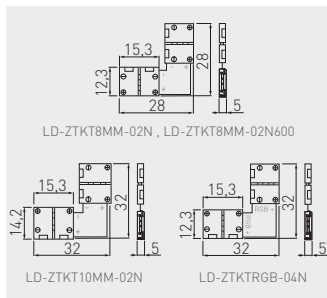

LD-ZTKT8MM-02N	8 mm	tworzywo plastic пластик
LD-ZTKT8MM-02N600	8 mm / 600 LED	
LD-ZTKT10MM-02N	10 mm	
LD-ZTKTRGB-04N	RGB	



Złącza XC11 do taśm LED z przewodem 15 cm
 Connector XC11 with 15 cm cord, for strips
 Соединитель XC11 для лент LED, с проводом 15 см



LD-ZTK8MM-02N

LD-ZTK8MM-02N600

LD-ZTK10MM-02N

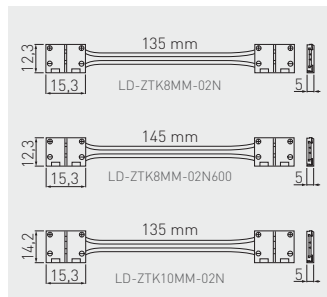

LD-ZTK8MM-02N	8 mm	tworzywo plastic пластик
LD-ZTK8MM-02N600	8 mm / 600 LED	
LD-ZTK10MM-02N	10 mm	



Złączka XC11 do taśm LED z przewodem 2 m
 Connector XC11 with 2 m cord, for LED strips
 Соединитель XC11 для лент LED, с проводом 2 м



LD-ZTL82M-2N LD-ZTL82M-2N600 LD-ZTL102M-2N LD-ZTLRGB2M-4N

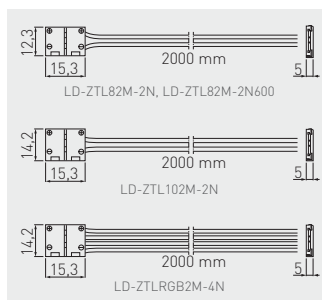

LD-ZTL82M-2N	8 mm	tworzywo plastic пластик
LD-ZTL82M-2N600	8 mm / 600 LED	
LD-ZTL102M-2N	10 mm	
LD-ZTLRGB2M-4N	RGB	



Złączka XC11 do taśm LED z przewodem 2 m i mini amp
 Connector XC11 with 2 m cord and mini AMP, for LED strips
 Соединитель XC11 для лент LED, с проводом 2 м и мини амп

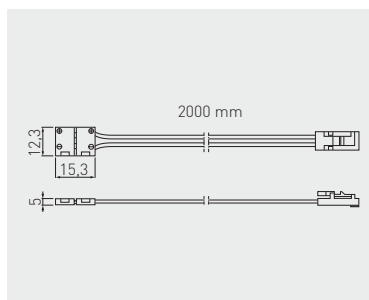

LD-ZTL8MMAMP-02N	8 mm	tworzywo plastic пластик
LD-ZTL8MMAMP-02N600	8 mm / 600 LED	



Złączka XC11 do taśm LED SLIM
 Connector XC11 for LED strips SLIM
 Соединитель XC11 для лент LED SLIM



LD-ZTLS8MM-02N LD-ZTKS8MM-02N LD-ZTLS82M-2N LD-ZTLS8MMAMP-02N

LD-ZTLS8MM-02N	8 mm	tworzywo plastic пластик
LD-ZTKS8MM-02N		
LD-ZTLS82M-2N		
LD-ZTLS8MMAMP-02N		

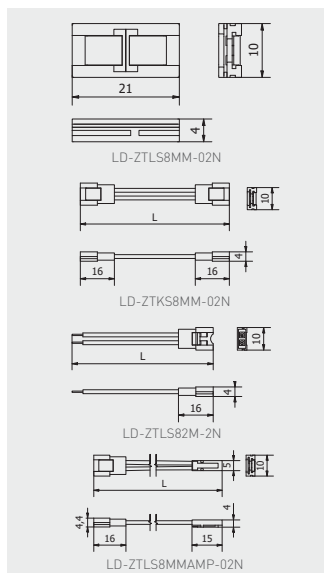

Ładowarka indukcyjna z zasilaczem
 Wireless charger with power supply
 Беспроводное зарядное устройство с блоком питания

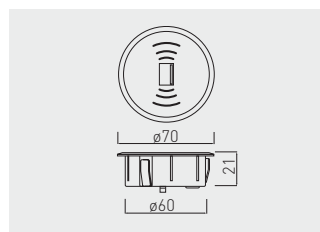

AE-ZUSB-20	czarny / black / чёрный	tworzywo plastic пластмасса



Ładowarka bezprzewodowa, indukcyjna, podblatowa z zasilaczem
 Wireless surface charger, under the countertop mount
 Беспроводное зарядное устройство, под столешницу

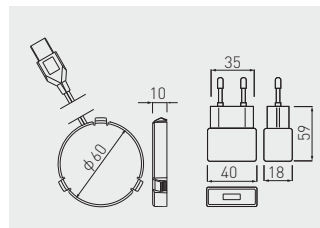

AE-ZLADPOD-20	czarny / black / чёрный	tworzywo plastic plastik



Ładowarka bezprzewodowa LUX z zasilaczem
 Inductive charger with a power feeder LUX
 Зарядное устройство индукционное с блоком питания LUX

NEW

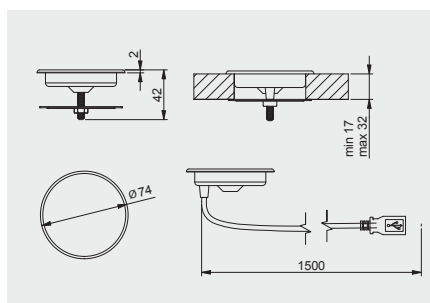

AE-ZLADLUX-40	chrom / chrome / хром	tworzywo plastic plastik



Przedłużacz biurkowy wpuszczany CHARGER
 Desk recessed power socket CHARGER
 Настольный удлинитель, встраиваемый CHARGER



AE-BPW1S2UCH-80

AE-BPW1U2UCH-80

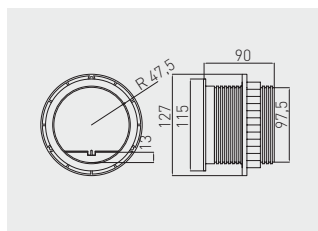

AE-BPW1S2UCH-80	100	schuko	srebrny silver	tworzywo plastic
AE-BPW1U2UCH-80		french	серебристый	пластмасса



Przedłużacz biurkowy wpuszczany SLIDE
 Desk recessed power socket SLIDE
 Настольный удлинитель, встраиваемый SLIDE



AE-BPW1U1UCH-51

AE-BPW1S1UCH-51

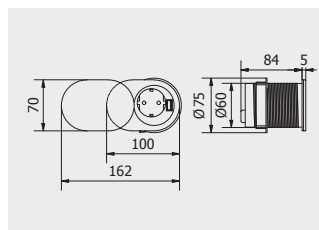

AE-BPW1U1UCH-51	french	USB 5V / 2,4A	aluminium aluminium	tworzywo plastic
AE-BPW1S1UCH-51	schuko		алюминий	пластмасса





GTV

16A
250V



Przedłużacz biurkowy wpuszczany CHARGER MINI
 Desk recessed power socket CHARGER MINI
 Настольный удлинитель, встраиваемый CHARGER MINI

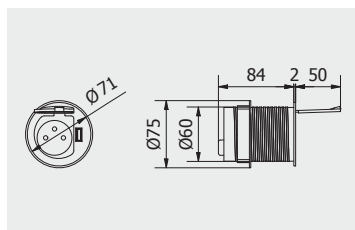

AE-BPW1S1UCH-53

AE-BPW1U1UCH-53

AE-BPW1U1UCH-53	60	french	aluminium aluminium алюминий	tworzywo plastic пластмасса
AE-BPW1S1UCH-53		schuko		



Przedłużacz biurkowy wpuszczany COMFORT
 Desk recessed power socket COMFORT
 Настольный удлинитель, встраиваемый COMFORT

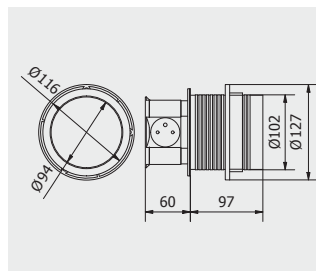

AE-BPW3S100U-53

AE-BPW4U100-53

AE-BPW4U100-53	100	french	-	aluminium aluminium алюминий	aluminium, tworzywo aluminium, plastic алюминий, пластмасса
AE-BPW4S100-53		schuko			
AE-BPW3U100U-53		french	5V USB max. 2A		
AE-BPW3S100U-53		schuko			





PRZEDŁUŻACZE BIURKOWE / DESKTOP POWER SOCKETS / ОФИСНЫЙ УДЛИНИТЕЛЬ

Przedłużacz biurkowy wpuszczany CHARGER MINI
Desk recessed power socket CHARGER MINI
Настольный удлинитель, встраиваемый CHARGER MINI



AE-BPW15TUCH-S3

AE-BPW15TUCH-S3

				Безопасно пластик материалы
AE-BPW15TUCH-S3	60	French schuko	aluminium aluminium алюминий	
AE-BPW15TUCH-S3				

Przedłużacz biurkowy wpuszczany okrągły \varnothing 100
 Pull-out power socket – round \varnothing 100
 Выдвижной настольный удлинитель, круглый \varnothing 100



AE-BPW3GU-80



AE-BPW3GU-20

	 mm			
AE-BPW3GU-20	100	french	czarny / black / чёрный	aluminium, tworzywo aluminium, plastic алюминий, пластмасса
AE-BPW3GU-80			srebrny / silver / серебристый	
AE-BPW3GS-20		schuko	czarny / black / чёрный	
AE-BPW3GS-80			srebrny / silver / серебристый	

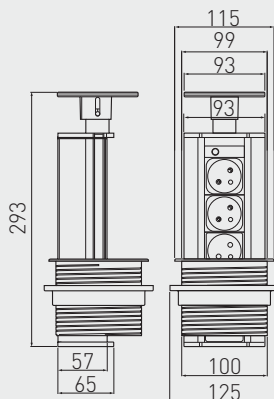



Przedłużacz biurkowy wpuszczany okrągły \varnothing 60
 Pull-out power socket – round \varnothing 60
 Выдвижной настольный удлинитель, круглый \varnothing 60



AE-BPW3U60-20



AE-BPW3U60-80



AE-BPW3U60U-20



AE-BPW3U60U-80

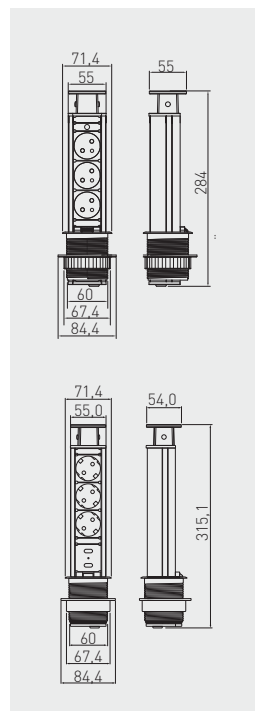

AE-BPW3U60-20	60	french	5V USB max. 2A	czarny / black / чёрный	aluminium, tworzywo aluminium, plastic алюминий, пластмасса
AE-BPW3U60-80				srebrny / silver / серебристый	
AE-BPW3S60-20		schuko		czarny / black / чёрный	
AE-BPW3S60-80				srebrny / silver / серебристый	
AE-BPW3U60U-20		french		czarny / black / чёрный	
AE-BPW3U60U-80				srebrny / silver / серебристый	
AE-BPW3S60U-20		schuko		czarny / black / чёрный	
AE-BPW3S60U-80				srebrny / silver / серебристый	



Przedłużacz biurkowy wpuszczany prostokątny
 Rectangular pop-up power and connection socket
 Настольный удлинитель, прямоугольный, врезной



AE-PB03GS-53	schuko	-	aluminium aluminium алюминий	stal, tworzywo steel, plastic сталь, пластмасса	
AE-PB03GU-53	french	-			
AE-PBC3GU-53	french	1,5 m			
AE-PBC3GU-20	french	1,5 m	czarny / black / чёрный		
AE-PBC3GU-10	french	1,5 m	biały / white / белый		



Przedłużacz biurkowy wpuszczany prostokątny
 Rectangular pop-up power and connection socket
 Настольный удлинитель, прямоугольный, врезной



AE-PBU2GU-10	french	biały / white / белый		stal, tworzywo steel, plastic сталь, пластмасса
AE-PBU2GU-20		czarny / black / чёрный		
AE-PBU2GU-53		aluminium / aluminium / алюминий		



Przedłużacz biurkowy bez kasety
 Through-desk power socket without housing
 Настольный удлинитель без корпуса

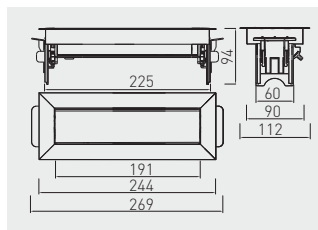

AE-PBC3GS-51BK	schuko		stal szczotkowana brushed steel	stal, aluminium, tworzywo steel, aluminium, plastic
AE-PBC3GU-51BK	french		шlifованная сталь шлифованная сталь	сталь, алюминий, пластмасса



Przedłużacz biurkowy przepustowy z USB
 Through-desk power socket letterbox brush cable access with USB
 Настольный удлинитель с пропуском под кабель с USB

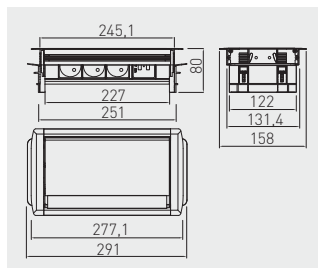

AE-PBC3GS-53BKS	schuko	-		aluminium aluminium алюминий	aluminium, tworzywo aluminium, plastic алюминий, пластмасса
AE-PBC3GU-53BKS	french	-			
AE-PBC3GS2U-53BKS	schuko	5V USB max. 2A			
AE-PBC3GU2U-53BKS	french	5V USB max. 2A			



Przedłużacz biurkowy przepustowy z HDMI

Through-desk power socket letterbox brush cable access with HDMI port

Настольный удлинитель с пропуском под кабель, с выходом HDMI



AE-PBC2GS1HDMI-53BKS



AE-PBC2GU1HDMI-53BKS

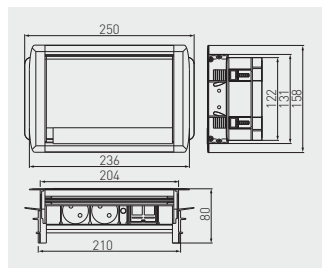

AE-PBC2GS1HDMI-53BKS	schuko	1 x HDMI	aluminium aluminium алюминий	aluminium, tworzywo aluminium, plastic алюминий, пластмасса
AE-PBC2GU1HDMI-53BKS	french			



Przedłużacz biurkowy kątowy MINI

Corner power socket MINI

Настольный удлинитель, угловой MINI

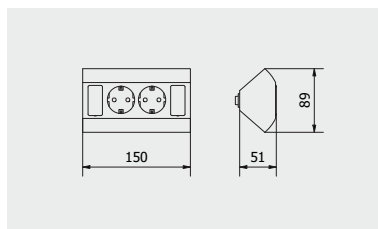

AE-PBKT2S-80	schuko	srebrny silver серебряный.	aluminium, tworzywo aluminium, plastic алюминий, пластмасса
AE-PBKT2F-80	french		



Przedłużacz biurkowy kątowy
 Corner power socket
 Настольный удлинитель, угловой



AE-PBKT4S-80

AE-PBKT3U2U-80

AE-PBKT4U-80	french	-		srebrny silver серебристый	aluminium, tworzywo aluminium, plastic алюминий, пластмасса
AE-PBKT4S-80	schuko				
AE-PBKT3U2U-80	french	5V USB max. 2A			
AE-PBKT3S2U-80	schuko				

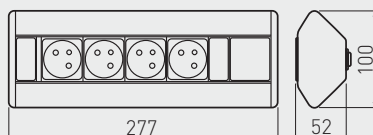



OBJAŚNIENIA IKON / ICONS EXPLANATION / ОПИСАНИЕ ИКОНОК



indeks
index
индекс



S
szerokość
width
ширина



dotądowe informacje
additional information
дополнительная информация



wysokość prowadnika
guide height
высота чашки



wymiary (mm)
dimensions (mm)
размеры (мм)



stopień ochrony IP
protection rating IP
степень защиты IP



wkręty zwykłe
wood screws
саморезы



wymiary (m)
dimensions (m)
размеры (м)



odległość cięcia
cutting distance
длина отрезка



euro wkręty
euro screws
евро саморезы



grubość
thickness
толщина



szerokość taśmy
strip width
ширина ленты



pokrycie
finish
покрытие



szerokość zewnętrzna szafki
outside width of the cabinet
наружная ширина ящика



USB
USB
USB



kolor
color
цвет



material
material
материал



rodzaj gniazda
socket type
тип гнезда



obciążenie
load
нагрузка



wyśuw
extension
выдвижение



moc
power
номинальный режим



pojemność
capacity
вместительность



kształt
shape
форма

Aksesoria meblowe Furniture accessories Мебельная фурнитура



siła oporu
strenght
сила опоры



strumień świetlny
luminous flux
номинальный световой поток



zawias nakładany
overlay door
накладная петля



długość
length
длина



długość przewodu
wire length
длина провода



zawias bliźniaczy
twin overlay
полунакладная петля



rozstaw
size
межцентровое расстояние



ilość diod
number of diodes
количество диод



zawias wpuszczany
inset door
вкладная петля



wysokość
height
высота



kolor obudowy
housing color
цвет корпуса



zawias kątowy
corner hinge
угловая петля



strata wysuwu
extension loss
потеря выдвижения



temperatura barwowa światła
color temperature
температура оттенка света



zawias o szerokim kącie otwarcia
wide angle hinge
петля с широким углом открывания



średnica
diameter
диаметр



kąt świecenia
beam angle
угол свечения



zawias równoległy
parallel hinge
петля под фальшьпанель (равнолежащая)

	zawias równoległy nakładany parallel hinge for overlay door петля накладная под фальшпанель		SLIDE-ON sposób montażu slide-on slide-on mounting надвижной монтаж slide-on		PUSH push-to-open
	zawias uzupełniający complementary hinge петля для складных дверей		SLOW zawias z mechanizmem cichego domyku hinge with soft closing петля с доводчиком Soft Close		FULL pełny wysuw full extension полное выдвижение
	regulacja adjustment регулировка		zawias ze sprężyną dociągającą hinge with closing spring петля с прижимной пружиной		szuflada standard standard drawer стандартный ящик
	działanie jednostopniowe single action hinge одношаговая петля		zawias samootwierający self-opening hinge петля самооткрывающаяся		szuflada zlewozmywakowa under sink drawer ящик под мойку
	działanie dwustopniowe double action hinge двухшаговая петля		zawias bez sprężyny hinge without spring петля без пружины		szuflada narożna corner drawer ящик угловой
	SPECIAL zawias do zastosowań specjalnych special hinge петля для специальных конструкций		A szuflada niska low drawer низкий ящик		szuflada standardowa standard drawer стандартный ящик
	Ø 35 mm średnica puszki hinge cup diameter диаметр чашки		B szuflada średnia medium drawer средний ящик		szuflada wewnętrzna inner drawer внутренний ящик
	45 mm rozstaw otworów puszek hinge cup drilling spacing межцентровое расстояние отверстий на чашке		C szuflada wysoka high drawer высокий ящик		przewodnica dolnego montażu under mount drawer направляющая нижнего монтажа
	montaż puszek na wkręty do drewna wood screw hinge cup mounting монтаж чашки на саморезы по дереву		regulacja pion i poziom vertical and horizontal adjustment регулировка по ширине и высоте		przewodnica kulkowa ball-bearing slide шариковая направляющая
	montaż przewodnika na wkręty do drewna wood screw mounting plate installation установка ответной планки на саморезы по дереву		opcja wyrzucenia release option снятие ящика без инструментов		przewodnica rolkowa roller slide роликовая направляющая
	montaż przewodnika na wkręty euro euro screw mounting plate installation установка ответной планки на евровинты		H=83 wysokość boku MB Square drawer side height MB Square высота боковой стенки MB Square		metalbox metalbox металбок
	montaż przewodnika na kolki dowel mount hinge монтаж чашки на саморезы с дюбелями		H=83 wysokość boku MB drawer side height MB высота боковой стенки MB		SLOW cichy domyk quiet shut бесшумное закрытие
	regulacja mimośrodowa eccentric adjustment эксцентриковая регулировка		H=95 wysokość boku AXIS drawer side height AXIS высота боковой стенки AXIS		SELF CLOSING samodociąg self closing доводчик
	x 100 pakowanie packing упаковка		3D dostępna bryła 3D 3D model available есть 3D модель		montaż nasuwany ze sprzęgłem push mounting with locking device надвижной монтаж с креплением фасада
	CLIP-ON sposób montażu clip-on clip-on mounting быстрый монтаж clip-on		CERTIFICATE \$0,000 trwałość tested durability кол-во циклов откр./закр.		montaż nakładany put on mounting накладной монтаж



PARTIAL

częściowy wysuw
partial extension
неполное выдвижение



max grubość płyty
max board thickness
макс. толщина плиты



regulacja pionowa
vertical adjustment
регулировка по ширине



regulacja pozioma
horizontal adjustment
регулировка по высоте



regulacja głębokości
depth adjustment
регулировка по глубине



zastosowanie do szkła
appliance glass
применение к стеклу



zastosowanie do szkła 4 mm
appliance glass 4 mm
применение к стеклу 4 mm



zastosowanie do płyty
appliance panel
применение к плите



zastosowanie do płyty 18 mm
appliance panel 18 mm
применение к плите 18 mm



zastosowanie do płyty 12 mm
appliance panel 12 mm
применение к плите 12 mm



zastosowanie do płyty 16 mm
appliance panel 16 mm
применение к плите 16 mm



zastosowanie do płyty 10 mm
appliance panel 10 mm
применение к плите 10 mm



zastosowanie do płyty ≥16 mm
appliance panel ≥16 mm
применение к плите ≥16 mm



zastosowanie do płyty 16 - 22 mm
appliance panel 16 - 22 mm
применение к плите 16 - 22 mm



zastosowanie do płyty 16 - 28 mm
appliance panel 16 - 28 mm
применение к плите 16 - 28 mm

Oświetlenie meblowe Furniture lighting Мебельное освещение



klasa efektywności
energy efficiency class
класс энергоэффективности



zasilanie napięciem przemiennym 220-240 V
220-240 V power supply AC
напряжение питания 220-240 В переменный ток



zasilanie napięciem stałym 12 V
12 V power supply DC
напряжение питания 12 В постоянный ток



zasilanie napięciem 12 V
12 V power supply
напряжение питания 12 В



napięcie wyjściowe
output voltage
напряжение на выходе



moc źródła światła lub urządzenia
light bulb or fixture power
мощность лампы или устройства



maksymalne dopuszczalne obciążenie
max permissible load
максимально допустимая нагрузка



kąt świecenia
beam angle
угол свечения



rodzaj diody
types of diode
тип диодов



ilość diod
number of diodes
количество диодов



długość przewodu
wire length
длина провода



długość przewodu z wtyczką
length of cord with plug
длина провода с вилкой



długość przewodu ze złączką
length of cord with connector
длина провода с соединителем



rodzaj złączki
type of connector
тип соединителя



rodzaj złączki
type of connector
тип соединителя



rodzaj złączki
type of connector
тип соединителя



stopień ochrony IP
international protection marking
пылевлагозащита IP



współczynnik oddawania barw
colour rendering index
индекс цветопередачи



współczynnik mocy
power factor
коэффициент мощности



liczb cykli wł./wył.
switching cycle
количество циклов вкл./выкл.



włącznik dotykowy ściemniający
dimnable touch switch
выключатель с регулятором яркости



oprawa z włącznikiem
fixture with switch
светильник с выключателем



sterowanie pilotem (IR/RF)
remote control (IR/RF)
управление с помощью пульта (IR/P0)



włącznik bezdotykowy dwubiegowy
two-pole touchless switch
бесконтактный переключатель / двухфункциональный



włącznik do szafy / jednobiegowy
single-pole touchless switch
переключатель для шкафов / однофункциональный



zasięg czujki ruchu
range of motion sensor
площадь действия сенсора



czas pracy
nominal lifetime
время работы



czas włączania
starting time (max)
время включения



trzonek źródła światła G4
base type G4
тип цоколя G4



temperatura pracy
working temperature
рабочая температура



gniazdo USB
USB port
USB – порт



maksymalne obciążenie gniazd USB
max load USB ports
максимальная нагрузка портов USB



gniazdo UK
UK socket
гнездо UK



ethernet
ethernet port
ethernet – порт



nie współpracuje ze ściemniaczami
non-dimmable
нет возможности подключения диммера



współpracuje ze ściemniaczami
dimmable
есть возможность подключения диммера



montaż na ścianie / suficie
application: indoor / ceiling mounted
монтаж на стене / потолке



rekomendowana odległość montażu od powierzchni
recommended mounting distance from surfaces
рекомендуется монтаж устройства на расстоянии



średnica otworu montażowego
mounting hole diameter
монтажное отверстие диаметром



akumulator
battery
аккумулятор



Maksymalne obciążenie na jeden kanał
Maximum load per channel
Максимальная нагрузка на один канал



Częstotliwość pracy pilota
Remote control frequency
Частота работы пульта



Maksymalna rozpraszana moc źródeł światła dla profilu rozgrzanego do maksymalnie 65 stopni C, dla wersji z kloszem.
Maximal dissipated power of lamps for heated profiles to 65°C, when applied with lampshades.
Максимальная рассеиваемая мощность источников света для нагреваемого профиля до максимум 65°C, для версии с абажуром.

KOLORY
COLORS
ЦВЕТА



10
biały
white
белый



80
srebrny
silver
серебристый



14
antyczna miedź
antique copper
античная медь



10M
biały mat
white matt
белый матовый



7
antyczne srebro
antique silver
античное серебро



20
czarny
black
чёрный



mleczny
milk
молочный



19
szary mat
grey matt
серый матовый



20M
czarny mat
black matt
чёрный матовый



CS
kremowy
ecru
экрю



2, 52
satyna
satin
сатин



58
wenge
wenge
венге



1, 40
chrom
chrome
хром



6, 51
stal szcztokowana
brushed steel
шлифованная сталь



3
mosiądz
brass
латунь



5, 53
aluminium
aluminium
алюминий



11
tytan szcztokowany
brushed titanium
шлифованный титан



4
antyczny mosiądz
antique brass
античная латунь



30
szary
gray
серый



12
czarny chrom
black chrome
чёрный хром



9
antyczny mosiądz
szcztokowany
antique brushed brass
античная шлифованная латунь



ocynk
zink – plated
оцинковка



13
tytan
titanium
титан



16
złoty mosiądz
golden brass
золотая латунь



22
kość stoniowa
ivory
слоновая кость



52
wiśnia
cherry
вишня



RZ
różowy
pink
розовый



17
brąz
bronze
коричневый



42
grusza
pear
груша



PM
pomarańczowy
orange
оранжевый



50
beż
beige
кремовый



30
brąz
brown
коричневый



15
miedź
copper
медь



7, 31, 732
ciemny brąz
dark brown
темно-коричневый



44
buk
beech
бук



61
ciemny mahoń
dark mahogany
темное красное дерево



41
olcha
alder
ольха



20, 48, 731
mahoń
mahogany
красное дерево



43
jasny brąz
light brown
светло-коричневый



NB
niebieski
blue
синий



51
calvados
calvados
кальвадос



ZL
zielony
green
зеленый

Klasa ochronności na pył, ciała stałe i wodę
Dust, solids & water ingress protection rating
Класс защиты от пыли, твердых тел и воды

IP	Stopień ochrony I Protection rating I Степень защиты I
0	Brak ochrony None Отсутствие защиты
1	Ochrona przed ciałami obcymi statymi o wielkości ponad 50 mm. Protection against ingress of > 50 mm bodies. Защита от попадания инородных твердых тел размером более 50 мм.
2	Ochrona przed ciałami stałymi przekraczającymi 12 mm. Protection against ingress of > 12 mm bodies. Защита от попадания инородных твердых тел размером более 12 мм.
3	Ochrona przed ciałami stałymi przekraczającymi 2,5 mm. Protection against ingress of > 2.5 mm bodies. Защита от попадания инородных твердых тел размером более 2,5 мм.
4	Ochrona przed ciałami stałymi przekraczającymi 1 mm. Protection against ingress of > 1 mm bodies. Защита от попадания инородных твердых тел размером более 1 мм.
5	Pyłoodporność Protection against ingress of dust Пылестойкость
6	Pyłoszczelność Dustproof Пылестойкость

IP	Stopień ochrony II Protection rating II Степень защиты II
0	Brak ochrony None Отсутствие защиты
1	Ochrona przed pionowo wpadającymi kroplami wody. Protection against dripping water (vertically falling drops). Защита от вертикально падающих капель воды.
2	Ochrona przed kroplami wody przy przechyleniu do 15°. Protection against dripping water when tilted up to 15°. Защита от капель воды, падающих под углом до 15°.
3	Ochrona przed rozpyloną wodą Protection against spraying water. Защита от распыленной воды.
4	Ochrona przed bryzgami wody Protection against splashing of water. Защита от брызг воды.
5	Ochrona przed strugami wody Protection against water jets Защита от струй воды
6	Ochrona przed falami Protection against powerful water jets (waves) Защита от волн
7	Ochrona przed zanurzeniem Protection against immersion Защита от погружения
8	Ochrona przed głębokim zanurzeniem Protection against deep immersion Защита от глубокого погружения

Klasa ochronności przed porażeniem elektrycznym

Electric shock protection class

Класс защиты от поражения электрическим током

Klasa bezpieczeństwa Safety class Класс безопасности	Symbol Symbol Символ	Wyjaśnienie Definition Пояснение
0	Brak None Нет Keine Nincs	<p>Ochronę przed porażeniem elektrycznym stanowi izolacja podstawowa. W przypadku uszkodzenia izolacji ochronę przeciwporażeniową powinny zapewnić odpowiednio korzystne warunki środowiskowe oraz położenie urządzenia poza dotykem bezpośrednim.</p> <p>The protection against electric shock relies on basic insulation only. In the event of insulation failure, electric shock protection shall be assured by suitably favourable environmental conditions and locating the equipment beyond the reach of direct touch.</p> <p>Защиту от поражения электрическим током обеспечивает основная изоляция. В случае повреждения изоляции защиту от поражения электрическим током должны обеспечить соответствующие благоприятные условия окружающей среды и размещение оборудования вне зоны прямого контакта.</p>
I		<p>W urządzeniach z I klasą ochronności bezpieczeństwo zapewnione jest przez połączenie wszystkich czynnych przewodzących elementów z przewodem ochronnym lub bezpośrednio uziemieniem.</p> <p>Class I equipment provides protection by connecting all live conductive parts to a protective wire or directly to earth.</p> <p>В устройствах с I классом защиты безопасность обеспечивается посредством объединения всех действующих проводящих элементов с защитным проводом или непосредственно с заземлением.</p>
II		<p>W urządzeniach z II klasą ochronności bezpieczeństwo zapewnione jest przez zastosowanie izolacji podwójnej lub wzmocnionej, której w danych warunkach środowiskowych i przy napięciu znamionowym uważa się nie do przebicia.</p> <p>Class II equipment provides protection by the use of double or strengthened insulation, which is deemed breakdown-proof under given environmental conditions at the rated voltage.</p> <p>В устройствах с II классом защиты безопасность обеспечивается путем применения двойной или усиленной изоляции, которая в данных условиях окружающей среды и при номинальном напряжении считается непробиваемой.</p>
III		<p>Ochrona przeciwporażeniowa w urządzeniach z III klasy ochronności jest zapewniona przez obniżenie napięcia zasilania do wartości bezpiecznej w danych warunkach środowiskowych.</p> <p>Class III equipment protection against electric shock is provided by reduction of power voltage to a safe limit under given environmental conditions.</p> <p>Защита от поражения электрическим током в устройствах с III классом защиты обеспечивается снижением напряжения питания до безопасного в данных условиях окружающей среды значения.</p>

Indeks

A

		AE-PBC2G51HDMI-53BKS	529	AE-WLPR-60	510	A-HRS18-235-05	414
00-KLUCZREG-DPADPD	367	AE-PBC2GU1HDMI-53BKS	529	AE-WLPR-60P2	510	A-HRS18-235-90	414
A-B63-32	424	AE-PBC3G52U-53BKS	528	AE-WLSZN1-10	513	A-HRS18-300-05	414
A-B63-40	423	AE-PBC3G5-51BK	528	AE-WPDRW-00	509	A-HRS18-300-90	414
A-BUDP-SET	430	AE-PBC3G5-53BKS	528	AE-ZLADLUX-40	519	A-HRS18-405-05	414
A-BUD-UB	430	AE-PBC3GU2U-53BKS	528	AE-ZLADPOD-20	519	A-HRS18-405-90	414
A-BUD-UG	430	AE-PBC3GU-10	527	AE-ZUSB-20	518	A-HRS18-600-05	414
A-BUD-UM	430	AE-PBC3GU-20	527	A-H16-300-05	412	A-HRS18-600-90	414
A-BUD-UP	430	AE-PBC3GU-51BK	528	A-H16-300-90	412	A-K18-300-05	411
A-BUD-UR	430	AE-PBC3GU-53	527	A-H18-300-05	413	A-K18-300-10	411
A-C18-300-S-05	412, 427, 428	AE-PBC3GU-53BKS	528	A-H18-300-10	413	A-K18-300-20M	411
A-C18-300-S-10	412	AE-PBKT3S2U-80	530	A-H18-300-20M	413	A-K18-300-90	411
A-C18-300-S-20M	412	AE-PBKT3U2U-80	530	A-H18-300-90	413	A-KLP-4	422
A-C18-300-S-90	412	AE-PBKT4S-80	530	A-HR10-235-05	415	A-KR-4	421
A-DPG-16	417	AE-PBKT4U-80	530	A-HR10-235-90	415	A-LD4MOV-300-05	410
AE-BPW1S1UCH-51	520	AE-PBKTM2F-80	529	A-HR10-300-05	415	A-LD10-170-05	409
AE-BPW1S1UCH-53	522	AE-PBKTM2S-80	529	A-HR10-300-10	415	A-LD10-235-05	409
AE-BPW1S2UCH-80	520	AE-PBU2GU-10	527	A-HR10-300-90	415	A-LD10-235-90	409
AE-BPW1U1UCH-51	520	AE-PBU2GU-20	527	A-HR10-405-05	415	A-LD10-300-05	409
AE-BPW1U1UCH-53	522	AE-PBU2GU-53	527	A-HR10-405-90	415	A-LD10-300-10	409
AE-BPW1U2UCH-80	520	AE-WBBUNI-10DIM	508	A-HR10-600-05	415	A-LD10-300-90	409
AE-BPW3G5-20	524	AE-WBCUNI-10DIM	508	A-HR10-600-90	415	A-LD10-405-05	409
AE-BPW3G5-80	524	AE-WBEZDB-10S	506	A-HR10FL-300-05	415	A-LD10-405-90	409
AE-BPW3GU-20	524	AE-WBEZDC-10S	506	A-HR10FL-300-10	415	A-LD10-600-05	409
AE-BPW3GU-80	524	AE-WBEZDK15-10	506	A-HR10FL-300-90	415	A-LD10-600-90	409
AE-BPW3S60-20	526	AE-WBEZD-NB	509	A-HR18-300-05	414	A-LD10FL-300-05	411
AE-BPW3S60-80	526	AE-WBEZDPIR2-20	507	A-HR18-300-05RA	413	A-LD10FL-300-10	411
AE-BPW3S60U-20	526	AE-WBEZDPIR-10	507	A-HR18-300-10	414	A-LD10FL-300-90	411
AE-BPW3S60U-80	526	AE-WDBP1-10	505	A-HR18-300-20M	414	A-LD18-170-05	407
AE-BPW3S100U-53	522	AE-WDBP1-20	505	A-HR18-300-90	414	A-LD18-170-90	407
AE-BPW3U60-20	526	AE-WDBP2CCT-10	505	A-HR18-300-90RA	413	A-LD18-235-05	407
AE-BPW3U60-80	526	AE-WDBP2CCT-20	505	A-HR19-300-05	414	A-LD18-235-90	407
AE-BPW3U60U-20	526	AE-WDSB-10DIM	508	A-HRS10-170-05	415	A-LD18-300-05	407
AE-BPW3U60U-80	526	AE-WDSC-10DIM	508	A-HRS10-300-05	415	A-LD18-300-10	407
AE-BPW3U100U-53	522	AE-WLB01-10	510	A-HRS10-300-90	415	A-LD18-300-20M	407
AE-BPW4S100-53	522	AE-WLC01-20	510	A-HRS10-405-05	415	A-LD18-300-90	407
AE-BPW4U100-53	522	AE-WLIP44-15	511	A-HRS10-600-05	415	A-LD18-405-05	407
AE-PB03G5-53	527	AE-WLKON-20	511	A-HRS18-170-05	414	A-LD18-405-10	407
AE-PB03GU-53	527	AE-WLLAN1-10	512	A-HRS18-170-90	414	A-LD18-405-90	407

A-LD18-600-05	407	A-MEVO-235-20M	404	A-MPRO-170-05	406	A-R10NOV-270-10	401
A-LD18-600-90	407	A-MEVO-235-90	404	A-MPRO-170-10	406	A-R10NOV-270-90	401
A-LD19-300-05	408	A-MEVO-300-05	404	A-MPRO-170-20M	406	A-R10TORO-270-05	402
A-LG4MOV-300-05	409	A-MEVO-300-10A	404	A-MPRO-170-90	406	A-R10TORO-270-90	402
A-LG10-170-05	408	A-MEVO-300-20M	404	A-MPRO-235-05	406	A-R10TRAFO-270-05	401
A-LG10-235-05	408	A-MEVO-300-90	404	A-MPRO-235-10	406	A-R10TRAFO-270-90	401
A-LG10-235-90	408	A-MEVO-405-05	404	A-MPRO-235-20M	406	A-R16ERG-220-05	396
A-LG10-300-05	408	A-MEVO-405-10	404	A-MPRO-235-90	406	A-R16ERG-230-50	396
A-LG10-300-10	408	A-MEVO-405-20M	404	A-MPRO-300-05	406	A-R16ERG-270-50	396
A-LG10-300-90	408	A-MEVO-405-90	404	A-MPRO-300-10	406	A-R16ERG-270-90	396
A-LG10-405-05	408	A-MITO-PLUS	426	A-MPRO-300-20M	406	A-R18CARO-270-05	398
A-LG10-405-90	408	AM-KRZYZ-KPL	42	A-MPRO-300-90	406	A-R18CARO-270-90	398
A-LG10-600-05	408	AM-MBSOFT-P2	85	A-MPRO-405-05	406	A-R18COTE-270-05	399
A-LG10-600-90	408	AM-OAM-DL-GM-10	46	A-MPRO-405-10	406	A-R18COTE-270-90	399
A-LG10FL-300-05	410	AM-OAM-DL-GM-30	46	A-MPRO-405-20M	406	A-R18ERG-270-05	396
A-LG10FL-300-10	410	AM-OAM-DL-GM-60	46	A-MPRO-405-90	406	A-R18ERG-270-90	396
A-LG10FL-300-90	410	AM-OAM-DL-MG-10	46	AM-PROST-KPL	41	A-R18GE02-270-05	396
A-LG18-170-05	406	AM-OAM-DL-MG-30	46	AMR-BP-0715	47	A-R18LOCA-305-05	400
A-LG18-170-90	406	AM-OAM-DL-MG-60	46	AMR-BP-1003	47	A-R18LOCA-305-90	400
A-LG18-235-05	406	AM-OAM-KR-GM-10	46	A-MSOFT-ADAPT	425	A-R18NERO-270-05	399
A-LG18-235-90	406	AM-OAM-KR-GM-30	46	A-MSOFT-RAMA	424	A-R18NERO-270-10	399
A-LG18-300-05	406	AM-OAM-KR-GM-60	46	AM-ZAT-A1-10	45	A-R18NERO-270-20M	399
A-LG18-300-10	406	AM-OAM-KR-MG-10	46	A-PG-18	416	A-R18NERO-270-90	399
A-LG18-300-20M	406	AM-OAM-KR-MG-30	46	A-PGR-10	416	A-R18NOVS-270-05	397
A-LG18-300-90	406	AM-OAM-KR-MG-60	46	A-PGR-10S	417	A-R18NOVS-270-10	397
A-LG18-405-05	406	AM-ODB000-10	42	A-PGR-18	416	A-R18NOVS-270-20M	397
A-LG18-405-10	406	AM-ODB000-60	42	A-POZ-MITO	426	A-R18NOVS-270-90	397
A-LG18-405-90	406	AM-OWM-DL-GM-10	44	A-PTD 419		A-R18VIS-270-05	398
A-LG18-600-05	406	AM-OWM-DL-GM-30	44	A-PTG 419		A-R18VIS-270-90	398
A-LG18-600-90	406	AM-OWM-DL-GM-60	44	A-PW-RC-DOC	425	A-R19NERO-300-05	399
A-LG19-300-05	407	AM-OWM-DL-MG-10	44	A-R4MOV-270-05	400	A-R19NOVS-300-05	398
AM-ADAP0A-10	43	AM-OWM-DL-MG-30	44	A-R10ARCO-270-05	402	A-RD-MITO	426
AM-ADAP0A-60	43	AM-OWM-DL-MG-60	44	A-R10ARCO-270-90	402	A-RNOV2-270-05	397
AM-ADAP0B-10	43	AM-OWM-KR-GM-10	44	A-R10FALDA-270-05	402	A-RNOV2-270-10	397
AM-ADAP0B-60	43	AM-OWM-KR-GM-30	44	A-R10FALDA-270-90	402	A-RNOV2-270-90	397
A-MEVO-170-05	404	AM-OWM-KR-GM-60	44	A-R10FL-270-05	400	A-SG-MITO	426
A-MEVO-170-10A	404	AM-OWM-KR-MG-10	44	A-R10FL-270-10	400	A-SN-ADSET	427, 428
A-MEVO-170-20M	404	AM-OWM-KR-MG-30	44	A-R10FL-270-90	400	A-SN-FSET	427
A-MEVO-170-90	404	AM-OWM-KR-MG-60	44	A-R10FORM-270-05	401	A-SN-HSET1	428
A-MEVO-235-05	404	AM-PLA-DLU-0	45	A-R10FORM-270-90	401	A-SN-K19-270-05	427, 428
A-MEVO-235-10A	404	AM-PL-DL-MAG	45	A-R10NOV-270-05	401	A-SN-LOFT-200-20M	431

A-SN-POZ	428	A-TDEVO-300-90	404	A-TG-405-05	403	GP-0728-J4-B	298
A-SN-R19RIV-270-05	427, 428	A-TDEVO-405-05	404	A-TG-405-10	403	GP-0728-J4-C-04	298
A-SN-SDP-TU	429	A-TDEVO-405-10	404	A-TG-405-20M	403	GP-0728-J4-R	298
A-SN-SOFT-25	427, 428	A-TDEVO-405-20M	404	A-TG-405-90	403	GS-BERGA-1-01	279
A-SN-SOFT-40	427, 428	A-TDEVO-405-90	404	A-TG-600-05	403	GS-BERGA-1-02	279
A-SN-TDS-405-00	427	A-TDEVO-600-05	404	A-TG-600-10	403	GS-BERGA-1-05	279
A-SN-TDT-405-00	428	A-TDEVO-600-10	404	A-TG-600-20M	403	GS-BERGA-1-06	279
A-SN-TG-405-00	427, 428	A-TDEVO-600-20M	404	A-TG-600-90	403	GS-BERGA-1-10	279
A-SO-48X4	420	A-TDEVO-600-90	404	A-TG-BUD-200-00	430	GS-BERGA-1-12	279
A-SO-145X4	420	A-TDPRO-170-05	405	A-TG-BUD-300-00	430	GS-BERGA-1-20M	279
A-SO-145X4-10	420	A-TDPRO-170-10	405	A-TMITO-200-00	426	GZ-71C024-01	314
A-SO-145X4-20	420	A-TDPRO-170-20M	405	A-TMITO-200-05	426	GZ-ARDEA-1-09	302
A-SOFT-30	424	A-TDPRO-170-90	405	A-TMITO-250-00	426	GZ-CENTO-1-04	313
A-SOFT-50	424	A-TDPRO-235-05	405	A-TMITO-250-05	426	GZ-CENTO-1-07	313
A-SP-7X12	421	A-TDPRO-235-10	405	A-TMITO-300-00	426	GZ-CENTO-1-14	313
A-SP-48X7	420	A-TDPRO-235-20M	405	A-TMITO-300-05	426	GZ-CENTO-1-20M	313
A-SP-48X12	421	A-TDPRO-235-90	405	A-USZCZ-CHM4	423	GZ-CLEO-1-01	246
A-T18-300-05	412	A-TDPRO-300-05	405	A-USZCZ-TDEVO2	423	GZ-CLEO-1-05	246
A-T18-300-10	412	A-TDPRO-300-10	405	A-USZCZ-U4	422	GZ-CLEO-1-06	246
A-T18-300-90	412	A-TDPRO-300-20M	405	A-WD-EVO2	417	GZ-CRPA20-01	318
A-TDEVO2-170-05	405	A-TDPRO-300-90	405	A-WD-PRO	418	GZ-CRPA25-01	318
A-TDEVO2-170-90	405	A-TDPRO-405-05	405	A-WDR-EVO	418	GZ-CRPA30-01	318
A-TDEVO2-235-05	405	A-TDPRO-405-10	405	A-WDR-PRO	419	GZ-CRPA30-03	318
A-TDEVO2-235-90	405	A-TDPRO-405-20M	405	A-ZAC-WDEVO2	418	GZ-CRPA30-A1	318
A-TDEVO2-300-05	405	A-TDPRO-405-90	405	A-ZAT-TDEVO2	422	GZ-CRPA40-01	318
A-TDEVO2-300-90	405	A-TDPRO-600-05	405			GZ-CRPB20-01	318
A-TDEVO2-405-05	405	A-TDPRO-600-10	405	B		GZ-CRPB25-01	318
A-TDEVO2-405-90	405	A-TDPRO-600-20M	405	BP-SLZIGW-10	362	GZ-CRPB25-A1	318
A-TDEVO2-600-05	405	A-TDPRO-600-90	405	BP-SLZIGW-21	363	GZ-CRPB30-01	318
A-TDEVO2-600-90	405	A-TG-170-05	403			GZ-CRPB30-03	318
A-TDEVO-170-05	404	A-TG-170-10	403	E		GZ-CRPB30-A1	318
A-TDEVO-170-10	404	A-TG-170-20M	403	EM-SBL060-01	152	GZ-CRPB40-01	318
A-TDEVO-170-20M	404	A-TG-170-90	403	EM-SBL100-01	152	GZ-CRPB40-A1	318
A-TDEVO-170-90	404	A-TG-235-05	403	EM-SBL150-01	152	GZ-CRPC30-01	319
A-TDEVO-235-05	404	A-TG-235-10	403			GZ-CRPC30-A1	319
A-TDEVO-235-10	404	A-TG-235-20M	403	G		GZ-MILAN-32-01	258
A-TDEVO-235-20M	404	A-TG-235-90	403	GA-IMPER-1-02B	314	GZ-MILAN-32-05	258
A-TDEVO-235-90	404	A-TG-300-05	403	GA-IMPER-1-11	314	GZ-MILAN-32-06	258
A-TDEVO-300-05	404	A-TG-300-10	403	GA-IMPER-1-20M	314	GZ-MILAN-32-20M	258
A-TDEVO-300-10	404	A-TG-300-20M	403	GP-0728-J4-A-04	298	GZ-NORD-1-18	272
A-TDEVO-300-20M	404	A-TG-300-90	403	GP-0728-J4-A-07	298	GZ-NORD-1-20M	272

GZ-OLBIA-1-04	307	ID-RS-E-336256-06	282	KM-BH75MM-30	391	KO-6002MD-CR	220
GZ-PALER-1-07	300	ID-RS-E-336256-20M	282	KM-GREYROLL-50mm-BH	393	KO-6002MD-SR	220
GZ-ROYAL3-1-10-03	309	ID-RS-E-368288-06	282	KM-GREYROLL-50mm-ZH	393	KO-CMB150-PW-OC	221
GZ-TERNI-1-01	280	ID-RS-E-368288-20M	282	KM-GREYROLL-75mm-BH	393	KO-CMB200-PW-01	221
GZ-TERNI-1-02	280	ID-RS-E-400320-06	282	KM-GREYROLL-75mm-ZH	393	KO-CMB200-PW-10	221
GZ-TERNI-1-05	280	ID-RS-E-400320-20M	282	KM-RD-35-CF	391	KO-CMB200-PW-OC	221
GZ-TERNI-1-06	280			KM-RD-35-CF-20	391	KO-CMB300-PW-01	221
GZ-TERNI-1-09	280	K		KM-RD-35-SF	391	KO-CMB300-PW-10	221
GZ-TERNI-1-10	280	KK-D50-80-06	240	KM-RD-35-SF-20	391	KO-CMB300-PW-OC	221
GZ-TERNI-1-12	280	KK-D50100-06	240	KM-RD-50-CF	392	KO-SRH4550-40-OC	198
GZ-TERNI-1-15	280	KK-W60245-M0	239	KM-RD-50-CF-20	392	KO-SRH4550-50-OC	198
GZ-TERNI-1-16	280	KK-W60245-M1	239	KM-RD-50-SF	392	KO-SRH4550-60-OC	198
GZ-TERNI-1-20M	280	KK-W60245-M2	239	KM-RD-50-SF-20	392	KO-SRH45200-40-OC	198
GZ-UDINE-1-01	279	KK-W60245-M6	239	KM-RD-75-CF	392	KO-SRH45200-50-OC	198
GZ-UDINE-1-02	279	KK-W60800-M0	241	KM-RD-75-CF-20	392	KO-SRH45200-60-OC	198
GZ-UDINE-1-05	279	KK-W60800-M1	241	KM-RD-75-SF	392	KO-SRPR100-30-10	197, 199
GZ-UDINE-1-06	279	KK-W80800-D0	241	KM-RD-75-SF-20	392	KO-SRPR100-30-OC	197, 199
GZ-UDINE-1-10M	279	KK-W80800-D1	241	KM-SPAIN-40MM-18	393	KO-SRPR100-40-10	197, 199
GZ-UDINE-1-12N	279	KM-00-40-D20	388	KM-SPAIN-50MM-18	393	KO-SRPR100-40-OC	197, 199
GZ-UDINE-1-20M	279	KM-00-50-D20	388	KO-150BO-01	218	KO-SRPR100-50-10	197, 199
GZ-VENICE-1-20M	272	KM-0H-40-D20	388	KO-150BO-60	218	KO-SRPR100-50-OC	197, 199
GZ-VENICE-1-90	272	KM-0H-50-D20	388	KO-200BO-01	218	KO-SRPR100-60-10	197, 199
GZ-WP1136-04	310	KM-015030-10	388	KO-200BO-60	218	KO-SRPR100-60-OC	197, 199
GZ-WP1148-04	311	KM-015030-20	388	KO-1502BO-10	219	KO-SRPR150-30-10	197, 199
GZ-WP1152-04	311	KM-015038-10	388	KO-1502BO-CR	219	KO-SRPR150-30-OC	197, 199
GZ-WP1155-01	280	KM-015038-GM	389	KO-1502BO-SR	219	KO-SRPR150-40-10	197, 199
GZ-ZH-011-01A	281	KM-A035MM-00	389	KO-1502MD-CR	220	KO-SRPR150-40-OC	197, 199
GZ-ZH-011-05A	281	KM-A035MM-30	389	KO-1502MD-SR	220	KO-SRPR150-50-10	197, 199
		KM-A050MM-00	390	KO-2002BO-10	219	KO-SRPR150-50-OC	197, 199
		KM-A050MM-30	390	KO-2002BO-CR	219	KO-SRPR150-60-10	197, 199
HB-USB-4X-60	227	KM-AH35MM-00	389	KO-2002BO-SR	219	KO-SRPR150-60-OC	197, 199
		KM-AH35MM-30	389	KO-2002MD-CR	220	KO-SRPR200-30-10	197, 199
		KM-AH50MM-00	390	KO-2002MD-SR	220	KO-SRPR200-30-OC	197, 199
ID-RS-E-15696-20M	282	KM-AH50MM-30	390	KO-3002BO-10	219	KO-SRPR200-40-10	197, 199
ID-RS-E-188128-20M	282	KM-B050MM-00	390	KO-3002BO-SR	219	KO-SRPR200-40-OC	197, 199
ID-RS-E-220160-06	282	KM-B050MM-30	390	KO-3002MD-CR	220	KO-SRPR200-50-10	197, 199
ID-RS-E-220160-20M	282	KM-B075MM-00	391	KO-3002MD-SR	220	KO-SRPR200-50-OC	197, 199
ID-RS-E-272192-06	282	KM-B075MM-30	391	KO-4002MD-CR	220	KO-SRPR200-60-10	197, 199
ID-RS-E-272192-20M	282	KM-BH50MM-00	390	KO-4002MD-SR	220	KO-SRPR200-60-OC	197, 199
ID-RS-E-304224-06	282	KM-BH50MM-30	390	KO-5002MD-CR	220	KT-WP1147-04	312
ID-RS-E-304224-20M	282	KM-BH75MM-00	391	KO-5002MD-SR	220	KW-FS0125-01	144

KW-FS0140-01	144	LD-2835-600-20-NE4	434	LD-AB18ZB-53	484	LD-MAX60CB-40N	483
KW-FS0335-01	145	LD-2835-600-20-ZB	434	LD-AL24CB-53	476	LD-MAX60ZB-40N	483
KW-FS0350-01	145	LD-2835-600-65-CB	434	LD-AL24NE-53	476	LD-ML1000-00	489
KW-FS0375-01	145	LD-2835-600-65-NE4	434	LD-AL24ZB-53	476	LD-ML2000-00	489
KW-FS0425-03	145	LD-2835-600-65-ZB	434	LD-BOS1CBWB-53	487	LD-ML3000-00	490
KW-FS0450-03	145	LD-3014-1200-20-CB	435	LD-BOS1CBWG-53	487	LD-ML4000-00	490
KW-FS0650-01	146	LD-3014-1200-20-NE4	435	LD-CHIC16NE-10	487	LD-ML5000-00	491
		LD-3014-1200-20-ZB	435	LD-CHIC16NE-20	487	LD-NF12V6x12-65-CB	439
		LD-3528-300-20-CB	434	LD-COB12V-20-CB	438	LD-NF12V6x12-65-NE	439
LB-80X100-05	228	LD-3528-300-20-CB-50	436	LD-COB12V-20-NE	438	LD-NF12V6x12-65-ZB	439
LB-80X100-20	228	LD-3528-300-20-NE4P	434	LD-COB12V-20-ZB	438	LD-NKW18CB-40	486
LB-80X160-05	229	LD-3528-300-20-NE4P-50	436	LD-CS36CB-53	475	LD-NKW18ZB-40	486
LB-80X160-20	229	LD-3528-300-20-NI	434	LD-CS36NE-53	475	LD-NO24CB-00	485
LB-80X280-05	229	LD-3528-300-20-ZB	434	LD-CS36ZB-53	475	LD-NO24ZB-00	485
LB-80X280-20	229	LD-3528-300-20-ZB-50	436	LD-DIMLED-10	512	LD-OBP27CB-53	479
LB-80X500-05	230	LD-3528-300-65-CB	434	LD-EIW09CB-CZ	484	LD-OBP27ZB-53	479
LB-80X500-20	230	LD-3528-300-65-NE4	434	LD-FL36CB-00	485	LD-OJVCOB-CB	474
LB-K80X80-05	228	LD-3528-300-65-ZB	434	LD-FL36ZB-00	485	LD-OP408C-53	481
LB-K80X80-20	228	LD-3528-600-20-CB	434	LD-IRUSB-53	486	LD-OP456C-53	481
LD-3SKL-CBN	488	LD-3528-600-20-CB-50	436	LD-KABE2M-00	513	LD-OP609C-53	481
LD-3SKL-NBN	488	LD-3528-600-20-NE4	434	LD-KJVCOB-CB	472	LD-OPD5W0-CB	482
LD-3SKL-ZBN	488	LD-3528-600-20-NE4-50	436	LD-KJVCOB-ZB	472	LD-OPD9W0-CB	482
LD-2835-24V-300-20-CB	436	LD-3528-600-20-ZB	434	LD-KLPCB-00N	488	LD-OPT30S-53N	477
LD-2835-24V-300-20-NE4	436	LD-3528-600-20-ZB-50	436	LD-KLPNB-00N	488	LD-OPT60S-51N	477
LD-2835-24V-300-20-ZB	436	LD-3528-600-65-CB	434	LD-KLPZB-00N	488	LD-OPT60S-53N	477
LD-2835-24V-600-20-CB	436	LD-3528-600-65-NE4	434	LD-KONMINI-RGB	498	LD-PIRUSB-53	486
LD-2835-24V-600-20-NE4	436	LD-3528-600-65-ZB	434	LD-KONML-AD	503	LD-PJVCOB-CB	474
LD-2835-24V-600-20-ZB	436	LD-5050-300-20-CB	435	LD-KONML-MONO	500	LD-RA60CB-40N	483
LD-2835-60-60-20-CCT	435	LD-5050-300-20-NE4	435	LD-KONML-MONO-PAN	501	LD-RA60ZB-40N	483
LD-2835-300-20-CB	434	LD-5050-300-20-NE4-50	436	LD-KONML-MONO-PIL	500	LD-RGB-150-20	435
LD-2835-300-20-CB-50	436	LD-5050-300-20-ZB	435	LD-KONML-RGBW	501	LD-RGB-150-65	435
LD-2835-300-20-NE4P	434	LD-5050-300-65-CB	435	LD-KONML-RGBW-PIL	502	LD-RGBW-300-20	435
LD-2835-300-20-NE4P-50	436	LD-5050-300-65-NE4	435	LD-KONML-WRGB-PAN	502	LD-SR16CB-53	482
LD-2835-300-20-ZB	434	LD-5050-300-65-ZB	435	LD-KWP27CB-53	480	LD-SR16NE-53	482
LD-2835-300-20-ZB-50	436	LD-5630-300-20-CB	435	LD-KWP27ZB-53	480	LD-SR16ZB-53	482
LD-2835-300-65-CB	434	LD-5630-300-20-NE4	435	LD-LCG319-52	479	LD-TR24CB-53	477
LD-2835-300-65-ZB	434	LD-5630-300-20-NE4-50	436	LD-LU16CB-53	472	LD-TR24NE-53	477
LD-2835-600-5MM-20-CB	435	LD-5630-300-20-ZB	435	LD-LU16NE-53	472	LD-TR24ZB-53	477
LD-2835-600-5MM-20-NE4435	435	LD-5630-300-65-CB	435	LD-LU16ZB-53	472	LD-VA24CB-53	471
LD-2835-600-5MM-20-ZB	435	LD-5630-300-65-ZB	435	LD-LUG319-40	479	LD-VA24NE-53	471
LD-2835-600-20-CB	434	LD-AB18CB-53	484	LD-LUG319-52	479	LD-VA24ZB-53	471

L

LD-VE15CB-53	475	LD-ZTKTRGB-04N	516	MC-J01A-16-01	136	MP-150400-10	83
LD-VE15CBZB-53	476	LD-ZTL8MM-02N	515	MC-J01A-16-06	136	MP-150450-10	83
LD-VE15NE-53	475	LD-ZTL8MM-02N600	515	MC-J04A2-14-01	137	MP-150500-10	83
LD-VE15ZB-53	475	LD-ZTL8MMAMP-02N	517	MC-J04A2-14-05	137	MR-R0050-001	162
LD-WL2457-53	480	LD-ZTL8MMAMP-02N600	517	MC-J04A2-18-01	137	MR-RDRO-0000	160
LD-WZA20W-NW	495	LD-ZTL10MM-02N	515	MC-J04A2-22-01	137	MR-RS025-001	161
LD-WZA36W-NW	495	LD-ZTL82M-2N	517	MC-J60A27-01	137	MR-T1824-KPL	168
LD-WZA60W-NW	495	LD-ZTL82M-2N600	517	MC-J62-01	138	MR-TDL011-01	139
LD-WZA80W-NW	495	LD-ZTL102M-2N	517	MC-J63-01	134	MR-TH001-01	172
LD-WZA150W-NW	495	LD-ZTLRGB2M-4N	517	MC-J63-05	134	MR-TH002-L01	172
LD-Z3CSCB-53	478	LD-ZTLRGB-04N	515	MC-J65-08-01	135	MR-TH002-P01	172
LD-Z5CSCB-53	478	LD-ZTL8MM-02N	518	MC-J65-08-05	135	MR-TH004-001	167
LD-ZAC6WDE-RGB	498	LD-ZTL8MMAMP-02N	518	MC-J65-10-01	135	MR-TH005-001	166
LD-ZAS09WEC-30	494	LD-ZTL82M-2N	518	MC-J65-10-05	135	MR-TH009-001	169
LD-ZAS15WEC-30	494	LD-ZWND6W-10	497	MC-J65-12-01	135	MR-TH010-001	170
LD-ZAS20WEC-30	494	LD-ZWND12-10	497	MC-J65-12-05	135	MR-TH011-001	169
LD-ZAS24PRO80W-30	492	LD-ZZAS07PROKD6	493	MC-J123-01	135	MR-TH016-001	166
LD-ZAS30WEC-30	494	LD-ZZAS12PROKD6	493	MC-J123-05	135	MR-TH018-KPL	167
LD-ZAS60WEC-30	494	LD-ZZAS16PROKD6	493	MC-K135-06-01	136	MR-TH018-L01	173
LD-ZAS75W-30	492	LD-ZZAS24PROKD6	493	MG-MENSA-010	155	MR-TH018-P01	173
LD-ZAS150-NW	494	LD-ZZAS33PROKD6	493	MG-MENSA-030	155	MR-TH019-001	174
LD-ZAS350-NW	495	LMB-BOCZ38L-05	157	MM-FI20X6X7-PL10	152	MR-TH019-003	174
LD-ZASPRO07W-30	491	LMB-BOCZ38L-20M	157	MM-FI20X6X7-PL20	152	MR-TH024-KPL	168
LD-ZASPRO12W-30	491	LMB-BOCZ38P-05	157	MM-FI20X6X7-PL30	152	MR-TH035-KPL	170
LD-ZASPRO16W-30	491	LMB-BOCZ38P-20M	157	MM-FI20X6X7-PL80	152	MR-TH048-001	175
LD-ZASPRO24W-30	491	LMB-KAT38-05	158	MM-FI20X6X7-ZN	152	MR-THA12-001	164
LD-ZASPRO33W-30	491	LMB-KAT38-20M	158	MP-054350-10	83	MR-THB12-001	165
LD-ZASPRO54W-30	491	LMB-SZCZ38-05	159	MP-054400-10	83	MR-THQZ1-001	173
LD-ZASPRO65W-30	491	LMB-SZCZ38-20M	159	MP-054450-10	83	MR-WP-010-01	163
LD-ZASPRO80W-30	491	LO-00-00-001	157	MP-054450-80	83	MR-WP-011-01	164
LD-ZASPU15W-30N	496	LO-00-00-003	157	MP-054500-10	83	MR-WP013-001	165
LD-ZL5RGB150-00	437	LO-M2M-00-125	151	MP-054500-80	83	MR-WP-14-KPL	171
LD-ZLRGBW-300-20	437	LZ-AKZ312-10N	514	MP-086350-10	83	MR-WP-15-KPL	171
LD-ZSKL15-00	496	LZ-AKZ612-10N	515	MP-086350-80	83	MR-WP-028-01	160
LD-ZTK8MM-02N	516	LZ-KAPR2M-10	514	MP-086450-10	83	MR-WP2802-01	176
LD-ZTK8MM-02N600	516			MP-086450-80	83	MR-WP2804-01	177
LD-ZTK10MM-02N	516	M		MP-118350-10	83	MR-WP2806-01	177
LD-ZTK8MM-02N	518	MA-MATA-1-10	126	MP-118400-10	83	MR-WP2807-20	178
LD-ZTKT8MM-02N	516	MA-MATA-1-60	126	MP-118450-10	83	MR-WP2815-01	176
LD-ZTKT8MM-02N600	516	MC-J01A-12-01	136	MP-118500-10	83	MR-WPS01-001	179
LD-ZTKT10MM-02N	516	MC-J01A-12-06	136	MP-150350-10	83	MR-WPS03-001	179

MR-WPZ002-01	162	NM-A61100-06	371	NM-BD-712-M1	356	NM-G60820-05N	373
MR-WPZ003-01	163	NM-A61100-10N*	371	NM-BD727-100	353	NM-G60820-06N	373
MR-WPZ006-01	175	NM-A61100-20	371	NM-BD-739-05	354	NM-G60820-10N*	373
MR-WPZ023-01	178	NM-A80710-01	372	NM-BD-762-01	349	NM-G60820-20N	373
MR-ZSL011-01	139	NM-A80710-02	372	NM-BD-762-05	349	NM-G61100-01N	373
		NM-A80710-03	372	NM-BD-780-M1	347	NM-G61100-20N	373
		NM-A80710-05	372	NM-BD-780-M2	347	NM-INDUSTRIA-H20-710X820-20M	
NM-46R710-05	381	NM-A80710-06	372	NM-BD-780-M5	347		382
NM-46R820-05	381	NM-A80710-10	372	NM-BD867-100	349	NM-INDUSTRIA-H40-710X820-20M	
NM-60R710-05	381	NM-A80710-20	372	NM-BD868-100	350		382
NM-60R710-06	381	NM-A80710-80	372	NM-BD868-150	350	NM-INDUSTRIA-P20-710X820-20M	
NM-60R710-20	381	NM-A80870-01	372	NM-BD869-150	350		384
NM-60R820-05	381	NM-A80870-02	372	NM-DAK27-060	354	NM-INDUSTRIA-P40-710X820-20M	
NM-60R1100-05	381	NM-A80870-03	372	NM-DAK27-080	354		384
NM-60R1100-20	381	NM-A80870-05	372	NM-DAK27-100	354	NM-INDUSTRIA-P80-710X820-20M	
NM-380X730-01	387	NM-A80870-06	372	NM-DAK27-120	354		384
NM-480X730-01	387	NM-A80870-10	372	NM-DAK27-150	354	NM-INDUSTRIA-T20-710X820-20M	
NM-A60710-01	371	NM-A80870-20	372	NM-DAP77-60	351		385
NM-A60710-02	371	NM-A80870-80	372	NM-DAP77-100	351	NM-INDUSTRIA-T40-710X820-20M	
NM-A60710-05	371	NM-ARTO-10-2R304-20M	380	NM-DAP77-150	351		385
NM-A60710-06	371	NM-ARTO-10-2R406-20M	380	NM-DPA20-100	366	NM-INDUSTRIA-X20-710X820-20M	
NM-A60710-10N	371	NM-ARTO-10-2R711-20M	380	NM-DPA20-100W	366		386
NM-A60710-20	371	NM-ARTO-10-3R304-20M	378	NM-DPA20-150	366	NM-INDUSTRIA-X40-710X820-20M	
NM-A60710-80N	371	NM-ARTO-10-3R406-20M	378	NM-DPA20-150W	366		386
NM-A60820-01	371	NM-ARTO-10-3R711-20M	378	NM-DPD20-100	365	NM-INDUSTRIA-X80-710X820-20M	
NM-A60820-02	371	NM-ARTO-12-2R304-20M	380	NM-F50710-01	375		386
NM-A60820-05	371	NM-ARTO-12-2R406-20M	380	NM-F50710-06	375	NM-KL-DPA-20	366
NM-A60820-06	371	NM-ARTO-12-2R711-20M	380	NM-F50710-10	375	NM-KL-DPL-20	365
NM-A60820-10N*	371	NM-ARTO-12-3R304-20M	378	NM-F50710-20	375	NM-MDN926-01	360
NM-A60820-20	371	NM-ARTO-12-3R406-20M	378	NM-F50870-01	375	NM-MDN927-01	360
NM-A60820-80N	371	NM-ARTO-12-3R711-20M	378	NM-F50870-06	375	NM-MDN941-01	361
NM-A60870-01*	371	NM-BAHIA40-150-01	351	NM-F50870-10	375	NM-MDN-D4-01	358
NM-A60870-02*	371	NM-BD-001-M1B	356	NM-F50870-20	375	NM-MLA-50-75	367
NM-A60870-05*	371	NM-BD-003-01	346	NM-G60710-01N	373	NM-MLA-65-85	368
NM-A60870-06*	371	NM-BD-003-02	346	NM-G60710-02N	373	NM-MLA-85-125	368
NM-A60870-10N*	371	NM-BD-100-01	348	NM-G60710-05N	373	NM-MLA-95-145	369
NM-A60870-20*	371	NM-BD-100-02	348	NM-G60710-06N	373	NM-MLA-125-195	369
NM-A60870-80N*	371	NM-BD-100-05	348	NM-G60710-10N	373	NM-MLA-KL	370
NM-A61100-01	371	NM-BD-100-06	348	NM-G60710-20N	373	NM-MUFAWB-00	364
NM-A61100-02	371	NM-BD-150-01	346	NM-G60710-80N	373	NM-MUFAWK-00	364
NM-A61100-05	371	NM-BD-150-02	346	NM-G60820-01N	373	NM-NACK27651-06	355

NM-S60710-01A	374	NM-X-LINE40710-20	376	PA-CPGLAXAH-00	440, 442,	PA-GLAXMW-AL-20M	455
NM-S60710-02A	374	NM-X-LINE40820-20	376		444, 446, 448	PA-GLAXMW-AL-90	455
NM-S60710-05A	374	NM-X-LINE40870-20	376	PA-CPGLAXAV-00	440, 442,	PA-GLAXNBD3M16-AL	466
NM-S60710-06A	374	NM-X-LINE401100-20	376		444, 446, 448	PA-GLAXNBD3M19-AL	466
NM-S60710-10A	374			PA-CPGLAXL-00	440, 442,	PA-GLAXNBD3M-AL	466
NM-S60710-20A	374	O			444, 446, 448	PA-GLAXNBDW3M16-AL	467
NM-S60820-01A	374	OC-2PV340-02-18	223	PA-GLAX3M-AL	454	PA-GLAXNBDW3M19-AL	467
NM-S60820-02A	374	OC-2PV345-02-18	223	PA-GLAX-AL	454	PA-GLAXNBDW3M-AL	467
NM-S60820-05A	374	OC-2PV350-02-18	223	PA-GLAX-AL-10	454	PA-GLAXNB3M16-AL	464
NM-S60820-06A	374	OC-2PV360-02-18	223	PA-GLAX-AL-20M	454	PA-GLAXNB3M19-AL	464
NM-S60820-10A	374	OC-2PV360-02-18A	223	PA-GLAX-AL-90	454	PA-GLAXNB3M-AL	464
NM-S60820-20A	374	OC-2PV370-02-18	223	PA-GLAXDR-AL	456	PA-GLAXNB3M16-AL	465
NM-SQ40ADJ-060	352	OC-2PV380-02-18	223	PA-GLAXGKL3M-00C	440	PA-GLAXNB3M19-AL	465
NM-SQ40ADJ-100	352	OC-2PV380-02-18A	223	PA-GLAXGKS3M-00C	442	PA-GLAXNB3M-AL	465
NM-SQA100-01	353	OC-2PV390-02-18	223	PA-GLAXGKW3M-00C	444	PA-GLAXNK3M-AL	451
NM-SQA150-01	353	OC-A0150-06	222	PA-GLAXGKWK3M-00C	446	PA-GLAXNK-AL	451
NM-STGC50-95-01	357	OC-A0160-06	222	PA-GLAXGKZK3M-00C	448	PA-GLAXNKKT3M-AL	459
NM-STGY135-100-01	357	OC-A0170-06	222	PA-GLAXKT3M-AL	468	PA-GLAXNKKT-AL	459
NM-STGY135-130-01	357	OC-A0180-06	222	PA-GLAXKT-AL	468	PA-GLAXNKKT-AL-10	459
NM-STGY135-150-01	357	OC-A0190-06	222	PA-GLAXMIC3M-AL	453	PA-GLAXNKKT-AL-20M	459
NM-STOMP-100-01	358	OC-A0350K-06	224	PA-GLAXMIC-AL	453	PA-GLAXNKKT-AL-90	459
NM-STOMP-120-10	358	OC-A0450-06	224	PA-GLAXMICNK3M-AL	449	PA-GLAXRAD-AL	457
NM-STOMP-120-20	358	OC-A0460D-06	225	PA-GLAXMICNK-AL	449	PA-GLAXREG1-AL	463
NM-STOMP-130-01	358	OC-A0660-06	222	PA-GLAXMNBW3M19-AL	461	PA-GLAXREG2-AL	463
NM-STOMP-130-06	358	OC-A0680-06	222	PA-GLAXMNBW3M-AL	461	PA-GLAXWN3M-AL	458
NM-STOMP-130-20	358	OC-E0707D-CZ	225	PA-GLAXMNB3M19-AL	460	PA-GLAXWN3M-AL-06	458
NM-STOMP-150-01	358	OM-OBK150-20B	242	PA-GLAXMNB3M-AL	460	PA-GLAXWN3M-AL-10	458
NM-STOMP-160-01	358	OM-OBK175-20	242	PA-GLAXMNK3M-AL	450	PA-GLAXWN3M-AL-20M	458
NM-STOMP-160-06	358	OM-OBO300-05	242	PA-GLAXMNK3M-AL-10	450	PA-GLAXWN16-AL	458
NM-STOMP-160-20	358	OM-OBO400-05	242	PA-GLAXMNK3M-AL-20M	450	PA-GLAXWN19-AL	458
NM-STOPKA-M6	363			PA-GLAXMNK-AL	450	PA-GLAXWN-AL	458
NM-STOPKZESTK-M6	364	P		PA-GLAXMNK-AL-10	450	PA-GLAXWPKT-AL	469
NM-STR50-100-01	347	PA-0241-35-50	290	PA-GLAXMNK-AL-20M	450	PA-OSMLGLAX-00	451, 454,
NM-STR50-120-01	347	PA-0242-35-50	288	PA-GLAXMNK-AL-90	450		456, 457, 458, 459, 463,
NM-STR50-150-01	347	PA-0242-35-50-06	288	PA-GLAXMNKW-AL	452		468, 469
NM-STR60-80-01	348	PA-0242-35-50-20M	288	PA-GLAXMNKW-AL-10	452	PA-OSMLGLAX3M-00	451,
NM-STSL-170-60-01	361	PA-0243-35-50	288	PA-GLAXMNKW-AL-20M	452		454, 458, 459,
NM-TOKYO40-150-01	355	PA-0243-35-50-06	288	PA-GLAXMNKW-AL-90	452		464, 465, 466,
NM-WPJ22-D20	362	PA-0243-35-50-20M	288	PA-GLAXMPK-AL	462		467, 468
NM-X-LINE40710-01	376	PA-0244-35-50	289	PA-GLAXMW-AL	455	PA-OSMLGLAXM-00	450, 452,
NM-X-LINE40710-10	376	PA-0245-35-50	289	PA-GLAXMW-AL-10	455		455, 462

PA-OSMLGLAXM3M-00	PA-VELLO-L3M-05	292	PA-ZASVELLO-LNL-05	292	PB-3D0SHX18-450-H	59
440, 442, 444,	PA-VELLO-L3M-06	292	PA-ZASVELLO-LNL-06	292	PB-3D0SHX18-500-H	59
446, 448, 450,	PA-VELLO-L3M-10	292	PA-ZASVELLO-LNL-10	292	PB-3D0SHX18-550-H	59
460, 461	PA-VELLO-L3M-20M	292	PA-ZASVELLO-LNL-20M	292	PB-45-002X15-60A	210
PA-OSMLGLAXMIC-00N	PA-VELLO-TD3M-05	297	PA-ZASVELLO-LNP-05	292	PB-45-002X20-60A	208
449, 453	PA-VELLO-TD3M-06	297	PA-ZASVELLO-LNP-06	292	PB-45-0010X3-60A	207
PA-OSMLGLAXMIC3M-00N	PA-VELLO-TD3M-10	297	PA-ZASVELLO-LNP-10	292	PB-45-202X10-60A	208, 212
449, 453	PA-VELLO-TD3M-20M	297	PA-ZASVELLO-LNP-20M	292	PB-45-400MF-2X16-60A	206
PA-OSMLGLAXMK-00	PA-VELLO-TJ3M-05	296	PA-ZASVELLO-LPL-05	292	PB-45-450-2X20-60A	212
450, 455	PA-VELLO-TJ3M-06	296	PA-ZASVELLO-LPL-06	292	PB-45-450MF202X10-60A	213
PA-OSMLGLAXMK3M-00	PA-VELLO-TJ3M-10	296	PA-ZASVELLO-LPL-10	292	PB-45-600MF-2X27-60A	215
442, 444, 446, 448	PA-VELLO-TJ3M-20M	296	PA-ZASVELLO-LPL-20M	292	PB-45-002010-60A	207
PA-OSMLGLAXMO-00	PA-ZASGLAX-00	454	PA-ZASVELLO-LPP-05	292	PB-45-MF2X15-60A	211
450	PA-ZASGLAX-10	454	PA-ZASVELLO-LPP-06	292	PB-45-MF002X20-60A	209, 213
PA-OSMLGLAXMO3M-00	PA-ZASGLAX-20M	454	PA-ZASVELLO-LPP-10	292	PB-45-MF2X34-60A	214
440, 442, 444, 446, 448	PA-ZASGLAX-90	454	PA-ZASVELLO-LPP-20M	292	PB-45-MF202X10-60A	209
PA-OSMLGLAXSO-00	PA-ZASGLAXDR-00	456	PA-ZAWGLAXDR-00	456, 457	PB-45-MF342X17-60A	214
457	PA-ZASGLAXKT-00	468	PA-ZGLAXKTOMZ-00	471	PB-91024160V	215
PA-OSMLGLAXT-00	PA-ZASGLAXMIC-00	453	PA-ZGLAXMNKOMZ-00	470	PB-91104100B5-A	216
459	PA-ZASGLAXMICNK-00	449	PA-ZGLAXOMZ-00	470	PB-91114100B5-A	216
PA-OSMLGLAXT3M-00	PA-ZASGLAXMNK-00	450	PB-0FPO-250	61	PB-91164100B5-A	216
440, 442, 444, 446, 448	PA-ZASGLAXMNK-20M	450	PB-0FPO-270	61	PB-91634100B5V-A	216
PA-OSTRGLAX-00	PA-ZASGLAXMNK-90	450	PB-0FPO-300	61	PB-91644100B5V-A	216
451, 454, 456, 457,	PA-ZASGLAXMNKK-00	450	PB-0FPO-350	61	PB-AXISPRO-KPL69-450-10	89
458, 459, 463,	PA-ZASGLAXMNKO-00	450	PB-0FPO-400	61	PB-AXISPRO-KPL69-450-60	89
468, 469	PA-ZASGLAXMNKW-00	452	PB-0FPO-450	61	PB-AXISPRO-KPL69-500-10	89
PA-OSTRGLAX3M-00	PA-ZASGLAXMNKW-10	452	PB-0FPO-500	61	PB-AXISPRO-KPL69-500-60	89
451, 454, 458, 459,	PA-ZASGLAXMNKW-20M	452	PB-0FPO-550	61	PB-AXISPRO-KPL300A	87
464, 465, 466,	PA-ZASGLAXMW-00	455	PB-0FPO-600	61	PB-AXISPRO-KPL300A1	87
467, 468	PA-ZASGLAXMW-10	455	PB-0SHX-250-A	58	PB-AXISPRO-KPL300B	87
PA-OSTRGLAXM3M-00	PA-ZASGLAXMW-20M	455	PB-0SHX-270-A	58	PB-AXISPRO-KPL300B1	87
450, 440, 461	PA-ZASGLAXMW-90	455	PB-0SHX-300-A	58	PB-AXISPRO-KPL300C	88
PA-ROZGLAX-53	PA-ZASGLAXMWK-00	455	PB-0SHX-350-A	58	PB-AXISPRO-KPL300C1	88
456	PA-ZASGLAXNK-00	451	PB-0SHX-400-A	58	PB-AXISPRO-KPL300D	88
PA-ROZGLAXP-53	PA-ZASGLAXNKKT-00	459	PB-0SHX-450-A	58	PB-AXISPRO-KPL300D1	88
456	PA-ZASGLAXNKKT-10	459	PB-0SHX-500-A	58	PB-AXISPRO-KPL350A	87
PA-SPRGLAXM-00	PA-ZASGLAXNKKT-20M	459	PB-0SHX-550-A	58	PB-AXISPRO-KPL350A1	87
450, 452, 457	PA-ZASGLAXNKKT-90	459	PB-0SHX-600-A	58	PB-AXISPRO-KPL350B	87
PA-SPRGLAXMIC-00	PA-ZASGLAXNKKT-00	459	PB-3D0SHX18-300-H	59	PB-AXISPRO-KPL350B1	87
449, 459	PA-ZASGLAXNKKT-10	459	PB-3D0SHX18-350-H	59	PB-AXISPRO-KPL350C	88
PA-USZGLAX-00N	PA-ZASGLAXRAD-00	457	PB-3D0SHX18-400-H	59	PB-AXISPRO-KPL350C1	88
458						
PA-USZGLAX-10N						
458						
PA-VELLO-C3M-05						
294						
PA-VELLO-C3M-06						
294						
PA-VELLO-C3M-10						
294						
PA-VELLO-C3M-20M						
294						

PB-AXISPRO-KPL350D	88	PB-AXISPRO-RELKW450-1093	PB-D-BXSIDEKW30C-10	102	PB-D-KPL400A	107
PB-AXISPRO-KPL350D1	88	PB-AXISPRO-RELKW500	PB-D-BXSIDEKW30C-60	102	PB-D-KPL400A1	107
PB-AXISPRO-KPL400A	87	PB-AXISPRO-RELKW500-1093	PB-D-BXSIDEKW35C	102	PB-D-KPL400B	108
PB-AXISPRO-KPL400A1	87	PB-AXISPRO-RELKW550	PB-D-BXSIDEKW35C-10	102	PB-D-KPL400C	108
PB-AXISPRO-KPL400B	87	PB-AXISPRO-RELKW550-1093	PB-D-BXSIDEKW35C-60	102	PB-D-KPL400C1	108
PB-AXISPRO-KPL400B1	87	PB-AXISPRO-WEWMOCA	PB-D-BXSIDEKW40C	102	PB-D-KPL450A	107
PB-AXISPRO-KPL400C	88	PB-AXISPRO-WEWMOCA1	PB-D-BXSIDEKW40C-10	102	PB-D-KPL450A1	107
PB-AXISPRO-KPL400C1	88	PB-AXISPRO-WEWMOCB	PB-D-BXSIDEKW40C-60	102	PB-D-KPL450B	108
PB-AXISPRO-KPL400D	88	PB-AXISPRO-WEWMOCB1	PB-D-BXSIDEKW45C	102	PB-D-KPL450C	108
PB-AXISPRO-KPL400D1	88	PB-AXISPRO-WEWMOCC	PB-D-BXSIDEKW45C-10	102	PB-D-KPL450C1	108
PB-AXISPRO-KPL450A	87	PB-AXISPRO-WEWMOCC1	PB-D-BXSIDEKW45C-60	102	PB-D-KPL500A	107
PB-AXISPRO-KPL450A1	87	PB-AXISPRO-WEWMOCD	PB-D-BXSIDEKW50C	102	PB-D-KPL500A1	107
PB-AXISPRO-KPL450B	87	PB-AXISPRO-WEWMOCD1	PB-D-BXSIDEKW50C-10	102	PB-D-KPL500B	108
PB-AXISPRO-KPL450B1	87	PB-AXISPRO-ZESWEW-A1	PB-D-BXSIDEKW50C-60	102	PB-D-KPL500C	108
PB-AXISPRO-KPL450C	88	AXISPRO	PB-D-CONBXSID	115	PB-D-KPL500C1	108
PB-AXISPRO-KPL450C1	88	PB-AXISPRO-ZESWEW-A	PB-D-CONBXSIDE-10	115	PB-D-KPL550A	107
PB-AXISPRO-KPL450D	88	AXISPRO	PB-D-CONREL	115	PB-D-KPL550A1	107
PB-AXISPRO-KPL450D1	88	PB-AXISPRO-ZESWEW-B1	PB-D-CONREL-10	115	PB-D-KPL550B	108
PB-AXISPRO-KPL500A	87	AXISPRO	PB-D-CONREL-KW	100	PB-D-KPL550C	108
PB-AXISPRO-KPL500A1	87	PB-AXISPRO-ZESWEW-B	PB-D-CONREL-KW-10	100	PB-D-KPL550C1	108
PB-AXISPRO-KPL500B	87	AXISPRO	PB-D-CONREL-KW-60	100	PB-D-LR-00-0	113
PB-AXISPRO-KPL500B1	87	PB-AXISPRO-ZESWEW-C1	PB-D-D2R0-00	101, 119	PB-D-LR-00-10	113
PB-AXISPRO-KPL500C	88	AXISPRO	PB-D-D2R0-01	101, 119	PB-D-MATRYCA	105, 119
PB-AXISPRO-KPL500C1	88	PB-AXISPRO-ZESWEW-C	PB-D-KPL68-450-10	121	PB-D-MBSTAB-00	121
PB-AXISPRO-KPL500D	88	AXISPRO	PB-D-KPL68-450-80	121	PB-D-MHG04	120
PB-AXISPRO-KPL500D1	88	PB-AXISPRO-ZESWEW-D1	PB-D-KPL68-500-10	121	PB-D-MHG04-KW	104
PB-AXISPRO-KPL550A	87	AXISPRO	PB-D-KPL68-500-80	121	PB-D-N2R0-00	103, 117
PB-AXISPRO-KPL550A1	87	PB-AXISPRO-ZESWEW-D	PB-D-KPL250A	107	PB-D-N2R0-01	103, 117
PB-AXISPRO-KPL550B	87	AXISPRO	PB-D-KPL250A1	107	PB-D-P20250A	107
PB-AXISPRO-KPL550B1	87	PB-D-BXSIDE45B	PB-D-KPL250C	108	PB-D-P20300A	107
PB-AXISPRO-KPL550C	88	PB-D-BXSIDE45B-10	PB-D-KPL250C1	108	PB-D-P20300C	108
PB-AXISPRO-KPL550C1	88	PB-D-BXSIDE45C	PB-D-KPL300A	107	PB-D-P20350A	107
PB-AXISPRO-KPL550D	88	PB-D-BXSIDE45C-10	PB-D-KPL300A1	107	PB-D-P20350C	108
PB-AXISPRO-KPL550D1	88	PB-D-BXSIDE50B	PB-D-KPL300B	108	PB-D-P20400A	107
PB-AXISPRO-RELKW300	93	PB-D-BXSIDE50B-10	PB-D-KPL300C	108	PB-D-P20400C	108
PB-AXISPRO-RELKW300-10	93	PB-D-BXSIDE50C	PB-D-KPL300C1	108	PB-D-P20450A	107
PB-AXISPRO-RELKW350	93	PB-D-BXSIDE50C-10	PB-D-KPL350A	107	PB-D-P20450C	108
PB-AXISPRO-RELKW350-1093		PB-D-BXSIDEKW25C	PB-D-KPL350A1	107	PB-D-P20500A	107
PB-AXISPRO-RELKW400	93	PB-D-BXSIDEKW25C-10	PB-D-KPL350B	108	PB-D-P20500C	108
PB-AXISPRO-RELKW400-1093		PB-D-BXSIDEKW25C-60	PB-D-KPL350C	108	PB-D-P20550C	108
PB-AXISPRO-RELKW450	93	PB-D-BXSIDEKW30C	PB-D-KPL350C1	108	PB-D-P20STAB	85

PB-D-PRZEGLP	116	PB-D-WEWMOCB-KW	97	PB-KW-KPL250A2	95	PB-KW-KPL450C2	96
PB-D-PRZEGLP-10	116	PB-D-WEWMOCB-KW-10	97	PB-KW-KPL250B	95	PB-KW-KPL500A	95
PB-D-PRZEGLP-KW	101	PB-D-WEWMOCC	111	PB-KW-KPL250B1	95	PB-KW-KPL500A1	95
PB-D-PRZEGLP-KW-10	101	PB-D-WEWMOCC1	111	PB-KW-KPL250B2	95	PB-KW-KPL500A2	95
PB-D-REL450-10	109	PB-D-WEWMOCC-KW	98	PB-KW-KPL250C	96	PB-KW-KPL500B	95
PB-D-REL500-10	109	PB-D-WEWMOCC-KW-10	98	PB-KW-KPL250C1	96	PB-KW-KPL500B1	95
PB-D-REL550-10	109	PB-D-WEWMOCC-KW-60	98	PB-KW-KPL250C2	96	PB-KW-KPL500B2	95
PB-D-REL2500	109	PB-D-WEWORG-B	114	PB-KW-KPL300A	95	PB-KW-KPL500C	96
PB-D-REL3000	109	PB-D-WEWORG-B-10	114	PB-KW-KPL300A1	95	PB-KW-KPL500C1	96
PB-D-REL3500	109	PB-D-WEWORGKW-A	99	PB-KW-KPL300A2	95	PB-KW-KPL500C2	96
PB-D-REL4000	109	PB-D-WEWORGKW-A-10	99	PB-KW-KPL300B1	95	PB-KW-KPL550A	95
PB-D-REL4500	109	PB-D-WEWORGKW-A-60	99	PB-KW-KPL300B2	95	PB-KW-KPL550A1	95
PB-D-REL5000	109	PB-D-WEWORGKW-B	100	PB-KW-KPL300C	96	PB-KW-KPL550A2	95
PB-D-REL5500	109	PB-D-WEWORGKW-B-10	100	PB-KW-KPL300C1	96	PB-KW-KPL550B	95
PB-D-RELCOV	114	PB-D-WEWORGKW-B-60	100	PB-KW-KPL300C2	96	PB-KW-KPL550B1	95
PB-D-RELCOV-10	114	PB-D-WEWSZKLC	110	PB-KW-KPL350A	95	PB-KW-KPL550B2	95
PB-D-RELKW350	96	PB-D-WEWSZKLC-10	110	PB-KW-KPL350A1	95	PB-KW-KPL550C	96
PB-D-RELKW350-10	96	PB-D-ZESWEW-C	111	PB-KW-KPL350A2	95	PB-KW-KPL550C1	96
PB-D-RELKW400	96	PB-D-ZESWEW-C-10	111	PB-KW-KPL350B	95	PB-KW-KPL550C2	96
PB-D-RELKW400-10	96	PB-D-ZESWEWKW-C	98	PB-KW-KPL350B1	95	PD-ECGDL-060	57
PB-D-RELKW450	96	PB-D-ZESWEWKW-C-10	98	PB-KW-KPL350B2	95	PD-ECGDL-080	57
PB-D-RELKW450-10	96	PB-D-ZESWEWKW-C-60	98	PB-KW-KPL350C	96	PD-ECGDL-150	57
PB-D-RELKW500	96	PB-D-ZLE-450	122	PB-KW-KPL350C1	96	PD-G0050-N02	51
PB-D-RELKW500-10	96	PB-D-ZLE-500	122	PB-KW-KPL350C2	96	PD-G0060-N02	51
PB-D-RELKW550	96	PB-D-ZNACZ-0	105, 120	PB-KW-KPL400A	95	PD-G0080-N02	51
PB-D-RELKW550-10	96	PB-D-ZR-00-0	112	PB-KW-KPL400A1	95	PD-G0100-N02	51
PB-D-RP-1100	112	PB-D-ZR-00-10	112	PB-KW-KPL400A2	95	PD-G0120-N02	51
PB-D-RP-1100-10	112	PB-D-ZR-KW-00	99	PB-KW-KPL400B	95	PD-G0150-N02	51
PB-D-S2R0-00	103, 118	PB-D-ZR-KW-10	99	PB-KW-KPL400B1	95	PD-G60160-02	52
PB-D-S2R0-01	103, 118	PB-D-ZR-KW-60	99	PB-KW-KPL400B2	95	PD-G80160-02	52
PB-D-UCHWEW	113	PB-G10HX-350	62	PB-KW-KPL400C	96	PD-GAM050-N02	50
PB-D-UCHWEW-10	113	PB-G10HX-450	62	PB-KW-KPL400C1	96	PD-GAM050-N10	50
PB-D-ULE-500	122	PB-G10HX-500	62	PB-KW-KPL400C2	96	PD-GAM050-N60	50
PB-D-W2R0-00	104, 118	PB-G10HX-550	62	PB-KW-KPL450A	95	PD-GAM060-N02	50
PB-D-W2R0-01	104, 118	PB-GCHX-300-H	60	PB-KW-KPL450A1	95	PD-GAM060-N10	50
PB-D-WEWMOCA	109	PB-GCHX-350-H	60	PB-KW-KPL450A2	95	PD-GAM060-N60	50
PB-D-WEWMOCA1	109	PB-GCHX-400-H	60	PB-KW-KPL450B	95	PD-GAM080-N02	50
PB-D-WEWMOCA-KW	97	PB-GCHX-450-H	60	PB-KW-KPL450B1	95	PD-GAM080-N10	50
PB-D-WEWMOCA-KW-10	97	PB-GCHX-500-H	60	PB-KW-KPL450B2	95	PD-GAM080-N60	50
PB-D-WEWMOCB	110	PB-GCHX-550-H	60	PB-KW-KPL450C	96	PD-GAM100-N02	50
PB-D-WEWMOCB1	110	PB-KW-KPL250A1	95	PB-KW-KPL450C1	96	PD-GAM100-N10	50

PD-GAM100-N60	50	PD-LIFT-P20-STRONG-80	48	PK-0H35-2500	76	PK-0H45450GX1	75	
PD-GAM120-N02	50	PD-LIFT-P20-STRONG-PLUS-10		PK-0H35-3000	76	PK-0H45500GX1	75	
PD-GAM120-N10	50		48	PK-0H35-3500	76	PK-0H45550GX1	75	
PD-GAM120-N60	50	PD-LIFT-P20-STRONG-PLUS-80		PK-0H35-4000	76	PK-0H45600GX1	75	
PD-GAM150-N02	50		48	PK-0H35-4500	76	PK-0H45650GX1	75	
PD-GAM150-N10	50	PD-MDLIFT-P1-D	55	PK-0H35-5000	76	PK-0H45700GX1	75	
PD-GAM150-N60	50	PD-MDLIFT-P2-D	56	PK-0-H45-250	74	PK-L-H45-250	66	
PD-GNEO12-50-10M	49	PD-MD-ZB-01-KPL	41	PK-0-H45-300	74	PK-L-H45-250-A	68	
PD-GNEO12-50-60	49	PD-MD-ZB-04-KPL	41	PK-0-H45-350	74	PK-L-H45-300	66	
PD-GNEO12-60-10M	49	PD-PD000-001	54	PK-0-H45-400	74	PK-L-H45-300-A	68	
PD-GNEO12-60-60	49	PG-AL4560-20	204	PK-0-H45-450	74	PK-L-H45-300-GX	69	
PD-GNEO12-80-10M	49	PG-AL6083-20	204	PK-0-H45-500	74	PK-L-H45-350	66	
PD-GNEO12-80-60	49	PG-AL8311520	204	PK-0-H45-550	74	PK-L-H45-350-A	68	
PD-GNEO15-50-10M	49	PG-GA4560-10	203	PK-0-H45-600	74	PK-L-H45-350-GX	69	
PD-GNEO15-50-60	49	PG-GA4560-20	203	PK-0-H45-700	74	PK-L-H45-400	66	
PD-GNEO15-60-10M	49	PG-GA6083-10	203	PK-0-H53-300	63	PK-L-H45-400-A	68	
PD-GNEO15-60-60	49	PG-GA6083-20	203	PK-0-H53-350	63	PK-L-H45-400-GX	69	
PD-GNEO15-80-10M	49	PG-GA83115-10	203	PK-0-H53-400	63	PK-L-H45-450	66	
PD-GNEO15-80-60	49	PG-GA8311520	203	PK-0-H53-450	63	PK-L-H45-450-A	68	
PD-GNEO15-100-10M	49	PG-ST4560-10	204	PK-0-H53-500	63	PK-L-H45-450-GX	69	
PD-GNEO15-100-60	49	PG-ST4560-10A	188	PK-0-H53-550	63	PK-L-H45-500	66	
PD-GNEO15-120-10M	49	PG-ST4560-20	204	PK-0-H53-600	63	PK-L-H45-500-A	68	
PD-GNEO15-120-60	49	PG-ST4560-60	188	PK-0-H53-650	63	PK-L-H45-500-GX	69	
PD-GNEO15-150-10M	49	PG-ST6083-10	204	PK-0-H53-700	63	PK-L-H45-550	66	
PD-GNEO15-150-60	49	PG-ST6083-10A	188	PK-0-H53-750	63	PK-L-H45-550-A	68	
PD-GPD01-001	53	PG-ST6083-20	204	PK-0-H53-800	63	PK-L-H45-550-GX	69	
PD-GPD02-002	53	PG-ST6083-60	188	PK-0-H53-900	63	PK-L-H45-600	66	
PD-GPD03-005	53	PG-ST83115-10	204	PK-0-H53-1000	63	PK-L-H45-600-A	68	
PD-LIFTNEW-LIGHT-10	48	PG-ST83115-10A	188	PK-0-H53-1100	63	PK-L-H45-600-GX	69	
PD-LIFTNEW-LIGHT-80	48	PG-ST83115-60	188	PK-0H17182XP	80	PK-L-P20-H45-300	64	
PD-LIFTNEW-MEDIUM-10	48	PG-ST8311520	204	PK-0H17214XP	80	PK-L-P20-H45-350	64	
PD-LIFTNEW-MEDIUM-80	48	PK-0-000-027	79	PK-0H17246XP	80	PK-L-P20-H45-400	64	
PD-LIFTNEW-STRONG-10	48	PK-0H27-3000	78	PK-0H17278XP	80	PK-L-P20-H45-450	64	
PD-LIFTNEW-STRONG-80	48	PK-0H27-3500	78	PK-0H17310XP	80	PK-L-P20-H45-500	64	
PD-LIFTNEW-STRONG-PLUS-10		PK-0H27-4000	78	PK-0H17342XP	80	PK-L-P20-H45-550	64	
		48	PK-0H27-4500	78	PK-0H17406XP	80	PK-L-P20-H45-600	64
PD-LIFT-P20-LIGHT-10	48	PK-0H27-5000	78	PK-0H17438XP	80	PK-P-H45-300-GX	71	
PD-LIFT-P20-LIGHT-80	48	PK-0H30-2500	77	PK-0H45250GX1	75	PK-P-H45-350-GX	71	
PD-LIFT-P20-MEDIUM-10	48	PK-0H30-3000	77	PK-0H45300GX1	75	PK-P-H45-400-GX	71	
PD-LIFT-P20-MEDIUM-80	48	PK-0H30-3500	77	PK-0H45350GX1	75	PK-P-H45-450-GX	71	
PD-LIFT-P20-STRONG-10	48	PK-0H30-4000	77	PK-0H45400GX1	75	PK-P-H45-500-GX	71	

PK-P-H45-550-GX	71	PM-NAR1004-680	148	PP-GINO-20M	340	PP-WIRE-20M	345
PK-P-H45-600-GX	71	PM-NAR1004-695	148	PP-GL-A48-01	130	PR-0B-250-10	81
PK-PRO-H45-250	72	PM-NAR1004-725	148	PP-GL-B48-01	130	PR-0B-250-18	81
PK-PRO-H45-300	72	PM-NAR1004-728	148	PP-GL-CGP-01	131	PR-0B-250-30	81
PK-PRO-H45-350	72	PM-NAR1004-732	148	PP-GL-DR5-01	138	PR-0B-300-10	81
PK-PRO-H45-400	72	PM-PFMH50-24	156	PP-GL-E410-01	131	PR-0B-300-18	81
PK-PRO-H45-450	72	PM-PFMH50-25	156	PP-HS0006-01	133	PR-0B-300-30	81
PK-PRO-H45-500	72	PM-PFMH51-10	156	PP-HS2710-01	134	PR-0B-350-10	81
PK-PRO-H45-550	72	PM-PFMH55-25	156	PP-INGRID-20M	342	PR-0B-350-18	81
PK-PRO-H45-600	72	PM-PFMH61-10	156	PP-LUK-00-01	141	PR-0B-350-30	81
PK-PRO-H45-650	72	PM-PFMH64-25	156	PP-LUK-00-02	141	PR-0B-400-10	81
PK-S-H45-250	70	PM-PLFI60-05	231	PP-LUK-00-05	141	PR-0B-400-18	81
PK-S-H45-300	70	PM-PLFI60-10	231	PP-MP0055-01	127	PR-0B-400-30	81
PK-S-H45-350	70	PM-PLFI60-20	231	PP-MP0055-02	127	PR-0B-450-10	81
PK-S-H45-400	70	PM-PLFI60-30	231	PP-MP0055-05	127	PR-0B-450-18	81
PK-S-H45-450	70	PM-PLFI60-43	231	PP-MP0055-06	127	PR-0B-450-30	81
PK-S-H45-500	70	PM-PLFI60-45	231	PP-NEO-20M	342	PR-0B-500-10	81
PK-S-H45-550	70	PM-PLFI60-47	231	PP-NW09X90B	140	PR-0B-500-18	81
PK-S-H45-600	70	PM-PLFI60-49	231	PP-NW10X100B	140	PR-0B-500-30	81
PK-S-H45-650	70	PM-PLFI60-50	231	PP-NW10X145B	140	PR-0B-550-10	81
PK-S-H45-700	70	PM-PLFI60-51	231	PP-NW12X120B	140	PR-0B-550-18	81
PM-LBFI60-01	230	PP-00GS02-01	128	PP-NW14X120B	140	PR-0B-600-10	81
PM-LBFI60-02	230	PP-00GS02-02	128	PP-NW14X140B	140	PR-0B-600-18	81
PM-LBFI60-05	230	PP-00GS02-05	128	PP-NW14X165B	140	PU-KEY027-20	226
PM-LBFI60-06	230	PP-00GS02-06	128	PP-P04570-20	202	PU-KEY027-60	226
PM-LBFI80-01	230	PP-00GS03-01	129	PP-P80110-20	202	PU-KEYM27-20	226
PM-LBFI80-02	230	PP-00GS03-02	129	PP-PMONT0D-22	147	PU-KEYM27-60	226
PM-LBFI80-05	230	PP-00GS03-05	129	PP-PMONT0M-01	146	PU-PKO-00-20	227
PM-LBFI80-06	230	PP-00GS03-06	129	PP-PMONT0M-07	146	PU-PKO-00-60	227
PM-NAR1003-512	147	PP-00GS04-01	129	PP-PMONT0M-08	146		
PM-NAR1003-645	147	PP-00GS04-02	129	PP-PMONT0M-22	146	R	
PM-NAR1003-677	147	PP-00GS04-05	129	PP-ROD-20M	344	RR-161030H01	161
PM-NAR1003-680	147	PP-00GS04-06	129	PP-S0L003-01T	132	RR-161230H01	161
PM-NAR1003-695	147	PP-BAR-20M	344	PP-S0L012-01T	133	RR-250730H01	161
PM-NAR1003-725	147	PP-BELT-20M	339	PP-SMART-000	140	RR-250830H01	161
PM-NAR1003-728	147	PP-DP0105-06	128	PP-SP0075-01	127	RR-250930H01	161
PM-NAR1003-732	147	PP-DP0105-01	128	PP-SP0075-02	127	RR-251030H01	161
PM-NAR1003-771	147	PP-DP0105-02	128	PP-SP0075-05	127	RR-401230H01	161
PM-NAR1004-512	148	PP-DP0105-05	128	PP-SP0075-06	127	RR-501030H01	161
PM-NAR1004-645	148	PP-FLAT-20M	339	PP-SPL001-01	139	RR-501230H01	161
PM-NAR1004-677	148	PP-GALA-20M	340	PP-TREE-20M	345	RR-CH-OW-000	159

RS-156096-01	282	RS-528448-02*	282	UA-00-337192-20M	268	UA-ARS128-20	249
RS-156096-02	282	RS-528448-05	282	UA-00-337224	268	UA-ARS160-20	249
RS-156096-05	282	RS528448-06*	282	UA-00-337224-20M	268	UA-ARS192-20	249
RS-156096-06	282	RS-528448-14*	282	UA-00-337256	268	UA-ARS224-20	249
RS-156096-14	282	RS-SZ-400-10	84	UA-00-337256-20M	268	UA-ARS256-20	249
RS-188128-01	282	RS-SZ-450-10	84	UA-00-337320	268	UA-ARS320-20	249
RS-188128-02	282	RS-SZ-500-10	84	UA-00-337320-20M	268	UA-ARSG30-20	249
RS-188128-05	282	RS-TRIES-96-06	281	UA-00-338128	268	UA-B0-311096	262
RS-188128-06	282	RS-TRIES-128-06	281	UA-00-338160	268	UA-B0-311096-20M	262
RS-188128-14	282	RS-TRIES-160-06	281	UA-00-340128	269	UA-B0-311128	262
RS-220160-01	282	RS-TRIES-192-06	281	UA-00-340160	269	UA-B0-311128-20M	262
RS-220160-02	282	RS-TRIES-256-06	281	UA-00-340192	269	UA-B0-311160	262
RS-220160-05	282	RS-TRIES-320-06	281	UA-00-340224	269	UA-B0-311160-20M	262
RS-220160-06	282			UA-00-340256	269	UA-B0-311192	262
RS-220160-14	282	S		UA-00-340320	269	UA-B0-311192-20M	262
RS-272192-01	282	SB-A60X72-80	387	UA-00-347128	269	UA-B0-311224	262
RS-272192-02	282	SZ-005-00-01-A	153	UA-00-347160	269	UA-B0-311224-20M	262
RS-272192-05	282	SZ-005-00-01T	153	UA-00-347192	269	UA-B0-311256	262
RS-272192-06	282	SZ-008-00-01-A	153	UA-00-347224	269	UA-B0-311256-20M	262
RS-272192-14	282	SZ-008-00-01T	153	UA-00-347256	269	UA-B0-311288	262
RS-304224-01	282			UA-00-347320	269	UA-B0-311288-20M*	262
RS-304224-02	282	T		UA-01-326096-V1	284	UA-B0-311320	262
RS-304224-05	282	TE-600000-30	497, 504	UA-01-326128-V1	284	UA-B0-311320-20M	262
RS-304224-06	282			UA-01-326160	284	UA-B0-311480	262
RS-304224-14	282	U		UA-18-128146	264	UA-B0-311480-20M*	262
RS-336256-01	282	UA-00-313128	264	UA-18-160178	264	UA-B0-337128	263
RS-336256-02	282	UA-00-313160	264	UA-18-192210	264	UA-B0-337160	263
RS-336256-05	282	UA-00-313192	264	UA-18-224242	264	UA-B0-337192	263
RS-336256-06	282	UA-00-319096	265	UA-18-256274	264	UA-B0-337224	263
RS-336256-14	282	UA-00-319128	265	UA-18-320338	264	UA-B0-337256	263
RS-368288-01	282	UA-00-319160	265	UA-18-400418	264	UA-B0-337320	263
RS-368288-02	282	UA-00-326096-20M	284	UA-A3-096128	262	UA-B31109601*	262
RS-368288-05	282	UA-00-326128-20M	284	UA-A3-128160	262	UA-B31112801	262
RS-368288-06	282	UA-00-326160-20M	284	UA-A18128-01	264	UA-B31116001	262
RS-368288-14	282	UA-00-337096	268	UA-A18160-01	264	UA-B31119201	262
RS-400320-01	282	UA-00-337096-20M	268	UA-A18192-01	264	UA-B31122401	262
RS-400320-02	282	UA-00-337128	268	UA-A18224-01	264	UA-B31125601	262
RS-400320-05	282	UA-00-337128-20M	268	UA-A18256-01	264	UA-B31128801*	262
RS-400320-06	282	UA-00-337160	268	UA-A18320-01	264	UA-B31132001	262
RS-400320-14	282	UA-00-337160-20M	268	UA-AA-114-05	263	UA-B31148001*	262
RS-528448-01	282	UA-00-337192	268	UA-ARS096-20	249	UA-DOPPI0192-01	265

UA-DOPPIO416-01	265	UA-PAXO-32-50-05	287	UM-KID-C-001	322	UZ-01-128-01	275
UA-HEXI-01	286	UA-PAXO-96-150-05	287	UM-KID-D-001	322	UZ-01-128-02	275
UA-HEXI-05	286	UA-PAXO-224-250-05	287	UM-KID-E-001	322	UZ-01-128-05	275
UA-HEXI-10M	286	UA-PAXO-320-350-05	287	UM-KID-I-002	322	UZ-02C064-01	315
UA-HEXI-18	286	UA-PAXO-3500-05	287	UM-KID-P-001	322	UZ-02C096-01	315
UA-HEXI-20M	286	UA-PICADO-224-496-01	291	UM-KID-Q-001	322	UZ-02CF27-01	315
UA-HEXI-60	286	UA-PICADO-224-496-05	291	UM-KID-U-001	322	UZ-05-096-01	275
UA-HEXI96-01	286	UA-PICADO-224-496-20M	291	UM-KID-W-001	323	UZ-05-096-02	275
UA-HEXI96-05	286	UA-PICADO-256-296-01	291	UM-KID-X-001	323	UZ-05-096-05	275
UA-HEXI96-10M	286	UA-PICADO-256-296-05	291	UM-KID-Z-001	323	UZ-05-128-01	275
UA-HEXI96-18	286	UA-PICADO-256-296-20M	291	UM-STAR-NB	320	UZ-05-128-02	275
UA-HEXI96-20M	286	UA-PICADO-256-596-01	291	UM-STAR-RZ	320	UZ-05-128-05	275
UA-HEXI96-60	286	UA-PICADO-256-596-05	291	UM-STAR-ZT	320	UZ-06-128-01	276
UA-HEXI192-01	286	UA-PICADO-256-596-20M	291	UM-TWITT-SZ	320	UZ-06-128-02	276
UA-HEXI192-05	286	UA-PICADO-320-396-01	291	UM-TWITT-ZL	320	UZ-06-128-05	276
UA-HEXI192-10M	286	UA-PICADO-320-396-05	291	UM-UNICORN-RZ	323	UZ-07-096-01	276
UA-HEXI192-18	286	UA-PICADO-320-396-20M	291	UP-WP0728-BB	298	UZ-07-096-02	276
UA-HEXI192-20M	286	UA-PICADO-352-796-01	291	UP-WP0728-BK	298	UZ-07-096-05	276
UA-HEXI192-60	286	UA-PICADO-352-796-05	291	UP-WP0728-BR	298	UZ-10-096-N04	301
UA-HEXI-3500-05	286	UA-PICADO-352-796-20M	291	UP-WP0728-BX	298	UZ-12-096-04	301
UA-HEXI-3500-20M	286	UA-TREX-32-50-05	287	UP-WP0728-P0	299	UZ-12-096-04N	301
UA-LIND-224-496-01	290	UA-TREX-32-50-20M	287	UP-WP0728-PA-04	299	UZ-12-096-20M	301
UA-LIND-224-496-05	290	UA-TREX-96-150-05	287	UP-WP0728-PA-07	299	UZ-13-096-01	277
UA-LIND-224-496-18	290	UA-TREX-96-150-20M	287	UP-WP0728-PB	299	UZ-13-096-02	277
UA-LIND-224-496-20M	290	UA-TREX-224-250-05	287	UP-WP0728-PC-04	299	UZ-13-096-05	277
UA-LIND-256-296-01	290	UA-TREX-224-250-20M	287	UP-WP0728-PK	299	UZ-14-096-01	278
UA-LIND-256-296-05	290	UA-TREX-320-350-05	287	UP-WP0728-PR	299	UZ-14-096-02	278
UA-LIND-256-296-18	290	UA-TREX-320-350-20M	287	UP-WP0728-PX	299	UZ-14-096-05	278
UA-LIND-256-296-20M	290	UA-TREX-3500-05	287	UZ-00B224-01	285	UZ-14-128-01	278
UA-LIND-256-596-01	290	UA-TREX-3500-20M	287	UZ-00B224-02	285	UZ-14-128-02	278
UA-LIND-256-596-05	290	UM-BLOCK-CZ	320	UZ-00B224-05	285	UZ-14-128-05	278
UA-LIND-256-596-18	290	UM-BLOCK-NB	320	UZ-00B224-10	285	UZ-40-032-01	253
UA-LIND-256-596-20M	290	UM-BLOCK-ZL	320	UZ-00B224-20	285	UZ-40-032-02	253
UA-LIND-320-396-01	290	UM-BUTTON-NB	320	UZ-00B226-01	285	UZ-40-032-05	253
UA-LIND-320-396-05	290	UM-BUTTON-SZ	320	UZ-00B226-02	285	UZ-40-032-06	253
UA-LIND-320-396-18	290	UM-CLOUD-NB	320	UZ-00B226-05	285	UZ-40-032-20M	253
UA-LIND-320-396-20M	290	UM-CLOUD-SZ	320	UZ-00B226-10	285	UZ-55-025-01	253
UA-LIND-352-796-01	290	UM-CROWN-RZ	320	UZ-00B226-20	285	UZ-55-025-05	253
UA-LIND-352-796-05	290	UM-FLAMING-RZ	320	UZ-01-096-01	275	UZ-60-032-01	254
UA-LIND-352-796-18	290	UM- FLAMING-SZ	320	UZ-01-096-02	275	UZ-60-032-02	254
UA-LIND-352-796-20M	290	UM-HEART-RZ	320	UZ-01-096-05	275	UZ-60-032-05	254

UZ-60-032-06	254	UZ-819128-02	260	UZ-819256-16	260	UZ-BAGIO-160-05	251
UZ-71C096-01	314	UZ-819128-05	260	UZ-819256-20	260	UZ-BAGIO-160-06	251
UZ-133128-01	254	UZ-819128-06	260	UZ-819320-01	260	UZ-BAGIO-160-07	251
UZ-133128-02	254	UZ-819128-07	260	UZ-819320-02	260	UZ-BAGIO-160-11	251
UZ-133128-05	254	UZ-819128-10	260	UZ-819320-05	260	UZ-BAGIO-160-20M	251
UZ-133128-06	254	UZ-819128-12	260	UZ-819320-06	260	UZ-BAGIO-192-01	251
UZ-133128-20M	254	UZ-819128-14	260	UZ-819320-07	260	UZ-BAGIO-192-04	251
UZ-334128-06	256	UZ-819128-15	260	UZ-819320-10	260	UZ-BAGIO-192-05	251
UZ-334160-06	256	UZ-819128-16	260	UZ-819320-12	260	UZ-BAGIO-192-06	251
UZ-334192-06	256	UZ-819128-20	260	UZ-819320-14	260	UZ-BAGIO-192-07	251
UZ-334256-06	256	UZ-819160-01	260	UZ-819320-20	260	UZ-BAGIO-192-11	251
UZ-334320-06	256	UZ-819160-02	260	UZ-ABIAT-128-04	305	UZ-BAGIO-192-20M	251
UZ-335128-06	256	UZ-819160-05	260	UZ-ACERA-96-04	306	UZ-BAGIO-320-01	251
UZ-335160-06	256	UZ-819160-06	260	UZ-ADRIN-96-04	306	UZ-BAGIO-320-04	251
UZ-335192-06	256	UZ-819160-07	260	UZ-ALATR-128-04	299	UZ-BAGIO-320-05	251
UZ-335256-06	256	UZ-819160-10	260	UZ-ANCON-128-01	252	UZ-BAGIO-320-06	251
UZ-336128-06	257	UZ-819160-12	260	UZ-ANCON-128-05	252	UZ-BAGIO-320-07	251
UZ-336160-06	257	UZ-819160-14	260	UZ-ANCON-128-06	252	UZ-BAGIO-320-11	251
UZ-336192-06	257	UZ-819160-15	260	UZ-ANCON-192-01	252	UZ-BAGIO-320-20M	251
UZ-336256-06	257	UZ-819160-16	260	UZ-ANCON-192-05	252	UZ-BIANC-96-01	317
UZ-336320-06	257	UZ-819160-20	260	UZ-ANCON-192-06	252	UZ-BIANC-128-01	317
UZ-336416-06	257	UZ-819192-01	260	UZ-ANCON-256-01	252	UZ-CALABRIA160-01	270
UZ-336480-06	257	UZ-819192-02	260	UZ-ANCON-256-05	252	UZ-CALABRIA160-06	270
UZ-682128-06	257	UZ-819192-05	260	UZ-ANCON-256-06	252	UZ-CALABRIA192-01	270
UZ-682160-06	257	UZ-819192-06	260	UZ-ARCH096-AEB	304	UZ-CALABRIA192-06	270
UZ-682192-06	257	UZ-819192-07	260	UZ-ARDEA-96-09	302	UZ-CALABRIA224-01	270
UZ-682224-06	257	UZ-819192-10	260	UZ-AREZO-96-04	305	UZ-CALABRIA224-06	270
UZ-682256-06	257	UZ-819192-12	260	UZ-ASTI096/128-01	248	UZ-CAMAI-96-01	278
UZ-682320-06	257	UZ-819192-14	260	UZ-ASTI1192/224-01	248	UZ-CAMAI-96-02	278
UZ-682416-06	257	UZ-819192-15	260	UZ-ASTI288/320-01	248	UZ-CAMAI-96-06	278
UZ-682480-06	257	UZ-819192-16	260	UZ-AZ-012-04	307	UZ-CAMAI-96-09	278
UZ-819096-01	260	UZ-819192-20	260	UZ-AZ-128-04	307	UZ-CAMAI-96-10M	278
UZ-819096-02	260	UZ-819256-01	260	UZ-BAGIO-128-01	251	UZ-CAMAI-96-12	278
UZ-819096-05	260	UZ-819256-02	260	UZ-BAGIO-128-04	251	UZ-CAMAI-96-20M	278
UZ-819096-06	260	UZ-819256-05	260	UZ-BAGIO-128-05	251	UZ-CAMAI-128-01	278
UZ-819096-07	260	UZ-819256-06	260	UZ-BAGIO-128-06	251	UZ-CAMAI-128-02	278
UZ-819096-10	260	UZ-819256-07	260	UZ-BAGIO-128-07	251	UZ-CAMAI-128-06	278
UZ-819096-12	260	UZ-819256-10	260	UZ-BAGIO-128-11	251	UZ-CAMAI-128-09	278
UZ-819096-14	260	UZ-819256-12	260	UZ-BAGIO-128-20M	251	UZ-CAMAI-128-10M	278
UZ-819096-20	260	UZ-819256-14	260	UZ-BAGIO-160-01	251	UZ-CAMAI-128-12	278
UZ-819128-01	260	UZ-819256-15	260	UZ-BAGIO-160-04	251	UZ-CAMAI-128-20M	278

UZ-CAPRI-96-01	259	UZ-COMO160-01	316	UZ-G0-192-06	271	UZ-GENUA128-20M	270
UZ-CAPRI-96-02	259	UZ-CRA14-128	315	UZ-G0-256-01	271	UZ-GENUA160-01	270
UZ-CAPRI-96-05	259	UZ-CRA14-192	315	UZ-G0-256-05	271	UZ-GENUA160-02	270
UZ-CAPRI-96-06	259	UZ-CRA14-320	315	UZ-G0-256-06	271	UZ-GENUA160-05	270
UZ-CAPRI-96-20M	259	UZ-E6-096-01	284	UZ-G1-128-01	271	UZ-GENUA160-20M	270
UZ-CAPRI-128-01	259	UZ-E6-096-05	284	UZ-G1-128-05	271	UZ-KATAN-320-01	252
UZ-CAPRI-128-02	259	UZ-E6-096-06	284	UZ-G1-128-06	271	UZ-KATAN-320-12	252
UZ-CAPRI-128-05	259	UZ-E6-128-01	284	UZ-G1-128-13	271	UZ-LUCCA128-01	317
UZ-CAPRI-128-06	259	UZ-E6-128-05	284	UZ-G1-128-20M	271	UZ-LUCCA160-01	317
UZ-CAPRI-128-20M	259	UZ-E6-128-06	284	UZ-G1-160-01	271	UZ-LUCCA192-01	317
UZ-CAPRI-160-01	259	UZ-E6-160-01	284	UZ-G1-160-05	271	UZ-LUCCA224-01	317
UZ-CAPRI-160-02	259	UZ-E6-160-05	284	UZ-G1-160-06	271	UZ-MARSA-64-07	308
UZ-CAPRI-160-05	259	UZ-E6-160-06	284	UZ-G1-160-13	271	UZ-MARSA-64-09	308
UZ-CAPRI-160-06	259	UZ-EVER-128-20M	273	UZ-G1-160-20M	271	UZ-MARSA-64-10M	308
UZ-CAPRI-160-20M	259	UZ-EVER-128-90	273	UZ-G1-192-01	271	UZ-MARSA-64-11	308
UZ-CAPRI-192-01	259	UZ-FLAVIO-96-01	267	UZ-G1-192-05	271	UZ-MARSA-64-15	308
UZ-CAPRI-192-02	259	UZ-FLAVIO-96-06	267	UZ-G1-192-06	271	UZ-MARSA-64-18	308
UZ-CAPRI-192-05	259	UZ-FLAVIO-96-16	267	UZ-G1-192-13	271	UZ-MARSA-64-20M	308
UZ-CAPRI-192-06	259	UZ-FLAVIO-96-20M	267	UZ-G1-192-20M	271	UZ-MILAN-128-01	258
UZ-CAPRI-192-20M	259	UZ-FLAVIO-128-01	267	UZ-G1-256-01	271	UZ-MILAN-128-05	258
UZ-CAPRI-256-01	259	UZ-FLAVIO-128-06	267	UZ-G1-256-05	271	UZ-MILAN-128-06	258
UZ-CAPRI-256-02	259	UZ-FLAVIO-128-16	267	UZ-G1-256-06	271	UZ-MILAN-128-20M	258
UZ-CAPRI-256-05	259	UZ-FLAVIO-128-20M	267	UZ-G1-256-13	271	UZ-MILAN-256-01	258
UZ-CAPRI-256-06	259	UZ-FLAVIO-160-01	267	UZ-G1-256-20M	271	UZ-MILAN-256-05	258
UZ-CAPRI-256-20M	259	UZ-FLAVIO-160-06	267	UZ-G1-320-01	271	UZ-MILAN-256-06	258
UZ-CAPRI-320-01	259	UZ-FLAVIO-160-16	267	UZ-G1-320-05	271	UZ-MILAN-256-20M	258
UZ-CAPRI-320-02	259	UZ-FLAVIO-160-20M	267	UZ-G1-320-06	271	UZ-MODEN-128-01	255
UZ-CAPRI-320-05	259	UZ-FLOW-128-06	274	UZ-G1-320-13	271	UZ-MODEN-128-05	255
UZ-CAPRI-320-06	259	UZ-FLOW-128-20M	274	UZ-G1-320-20M	271	UZ-MODEN-128-06	255
UZ-CAPRI-320-20M	259	UZ-FLOW-128-90	274	UZ-G1-416-01	271	UZ-MODEN-128-20M	255
UZ-CLEO-128-01	246	UZ-FLOW-192-06	274	UZ-G1-416-05	271	UZ-MODEN-160-01	255
UZ-CLEO-128-05	246	UZ-FLOW-192-20M	274	UZ-G1-416-06	271	UZ-MODEN-160-05	255
UZ-CLEO-128-06	246	UZ-FLOW-192-90	274	UZ-G2-160-01	248	UZ-MODEN-160-06	255
UZ-CLEO-160-01	246	UZ-G0-128-01	271	UZ-G2-160-06	248	UZ-MODEN-160-20M	255
UZ-CLEO-160-05	246	UZ-G0-128-05	271	UZ-G2-160-20M	248	UZ-MODEN-192-01	255
UZ-CLEO-160-06	246	UZ-G0-128-06	271	UZ-G2-224-01	248	UZ-MODEN-192-05	255
UZ-CLEO-192-01	246	UZ-G0-160-01	271	UZ-G2-224-06	248	UZ-MODEN-192-06	255
UZ-CLEO-192-05	246	UZ-G0-160-05	271	UZ-G2-224-20M	248	UZ-MODEN-192-20M	255
UZ-CLEO-192-06	246	UZ-G0-160-06	271	UZ-GENUA128-01	270	UZ-MONA-128-01-10	247
UZ-COMO096-01	316	UZ-G0-192-01	271	UZ-GENUA128-02	270	UZ-MONA-128-01-20	247
UZ-COMO128-01	316	UZ-G0-192-05	271	UZ-GENUA128-05	270	UZ-MONA-192-01-10	247

UZ-MONA-192-01-20	247	UZ-PRATO-320-01	250	UZ-VETA-320-01	246	WB-073024-06	141
UZ-MONA-256-01-10	247	UZ-PRATO-320-06	250	UZ-VETA-320-05	246	WB-073025-01	142
UZ-MONA-256-01-20	247	UZ-REN096-04A	312	UZ-VETA-320-12	246	WB-073025-06	142
UZ-MONZA16-10	247	UZ-RETRIS-128-04	302	UZ-VITO-160-01	266	WB-073026-01	142
UZ-MONZA160-06	247	UZ-RETRIS-128-07	302	UZ-VITO-160-05	266	WB-073026-06	142
UZ-MONZA160-10	247	UZ-RETRIS-128-20M	302	UZ-VITO-160-07	266	WB-WS-12-010	143
UZ-MONZA160-20	247	UZ-ROYAL1-96-10-03	309	UZ-VITO-160-12	266	WB-WS-18-010	143
UZ-MONZA256-06	247	UZ-ROYAL2-96-10-03	309	UZ-VITO-160-16	266	WB-WS-18-020	143
UZ-MONZA256-10	247	UZ-ROYAL3-96-10-03	309	UZ-VITO-160-20M	266	WB-WS-18-060	143
UZ-MONZA256-20	247	UZ-ROYAL4-96-03	309	UZ-VITO-288-01	266	WB-WS-24-010	144
UZ-MONZA384-06	247	UZ-ROYAL5-96-10-03	309	UZ-VITO-288-05	266	WB-WS-24-020	144
UZ-MONZA384-10	247	UZ-ROYAL5-128-10-03	309	UZ-VITO-288-07	266	W-CUSTOMI-60L450	124
UZ-MONZA384-20	247	UZ-SIENNA096-01	316	UZ-VITO-288-12	266	W-CUSTOMI-60L500	124
UZ-NORD-128-18	272	UZ-SIENNA128-01	316	UZ-VITO-288-16	266	W-CUSTOMI-80L450	125
UZ-NORD-128-20M	272	UZ-SIENNA160-01	316	UZ-VITO-288-20M	266	W-CUSTOMI-80L500	125
UZ-NORD-192-18	272	UZ-STEP-160-07	274	UZ-WERON-96-04	304	WG-KOSZ60-10	181
UZ-NORD-192-20M	272	UZ-STEP-160-20M	274	UZ-WERON-96-09	304	WG-KOSZ60-60	181
UZ-OCTAVIO-128-01	258	UZ-TH096128-01	267	UZ-WERON-96-12	304	WG-KOSZ70-10	181
UZ-OCTAVIO-128-06	258	UZ-TH096128-05	267	UZ-WERON-128-04	304	WG-KOSZ70-60	181
UZ-OCTAVIO-128-18	258	UZ-TH096128-06	267	UZ-WERON-128-09	304	WG-KOSZ80-10	181
UZ-OCTAVIO-128-20M	258	UZ-TH160192-01	267	UZ-WERON-128-12	304	WG-KOSZ80-60	181
UZ-OCTAVIO-160-01	258	UZ-TH160192-05	267	UZ-WP1146-04	310	WG-KOSZ90-10	181
UZ-OCTAVIO-160-06	258	UZ-TH160192-06	267	UZ-Z10096-01	277	WG-KOSZ90-60	181
UZ-OCTAVIO-160-18	258	UZ-TH288320-01	267	UZ-Z10096-02	277	WG-KOSZM60-10	180
UZ-OCTAVIO-160-20M	258	UZ-TH288320-06	267	UZ-Z10096-05	277	WG-KOSZM60-60	180
UZ-OCTAVIO-192-01	258	UZ-TIVOL-192-01	250	UZ-Z10096-20M	277	WG-KOSZM70-10	180
UZ-OCTAVIO-192-06	258	UZ-TIVOL-192-12	250	UZ-Z10128-01	277	WG-KOSZM70-60	180
UZ-OCTAVIO-192-18	258	UZ-TIVOL-192-13	250	UZ-Z10128-02	277	WG-KOSZM80-10	180
UZ-OCTAVIO-192-20M	258	UZ-TIVOL-320-01	250	UZ-Z10128-05	277	WG-KOSZM80-60	180
UZ-OLBIA-96-04	307	UZ-TIVOL-320-12	250	UZ-Z10128-20M	277	WG-KOSZM90-10	180
UZ-OLBIA-128-04	307	UZ-TIVOL-320-13	250			WG-KOSZM90-60	180
UZ-OTTO-128-06	273	UZ-VASTO-96-09	300	W		WG-KOSZR60-10	182
UZ-OTTO-128-20M	273	UZ-VASTO-128-09	300	WA-MALAG-A0-01	332	WG-KOSZR60-60	182
UZ-OTTO-128-90	273	UZ-VENICE-128-20M	272	WA-MALAG-A0-02	332	WG-KOSZR70-10	182
UZ-OTTO-160-06	273	UZ-VENICE-128-90	272	WA-MALAG-A0-05	332	WG-KOSZR70-60	182
UZ-OTTO-160-20M	273	UZ-VETA-128-01	246	WA-MALAG-A0-20	332	WG-KOSZR80-10	182
UZ-OTTO-160-90	273	UZ-VETA-128-05	246	WA-MALAG-B0-01	333	WG-KOSZR80-60	182
UZ-PALER-96-07	300	UZ-VETA-128-12	246	WA-MALAG-B0-02	333	WG-KOSZR90-10	182
UZ-PALER-128-07	300	UZ-VETA-160-01	246	WA-MALAG-B0-05	333	WG-KOSZR90-60	182
UZ-PRATO-160-01	250	UZ-VETA-160-05	246	WA-MALAG-B0-20	333	WG-POBUW60-10	183
UZ-PRATO-160-06	250	UZ-VETA-160-12	246	WB-073024-01	141	WG-POBUW60-60	183

WG-POBUW70-10	183	WK-D0320-001*	153	W-WKRP-BP-60	196	WW-WSL300-01	201
WG-POBUW70-60	183	WK-D0325-001*	153	W-WKRP-VE-10	196	WW-WSL350-01	201
WG-POBUW80-10	183	WK-D0330-001*	153	W-WKRP-VE-60	196	WW-WSL400-01	201
WG-POBUW80-60	183	WK-D0416-001	153	W-WOBU60-BP-10	191	WW-WSL450-01	201
WG-POBUW90-10	183	WK-D0425-001*	153	W-WOBU60-BP-60	190	WW-WSL500-01	201
WG-POBUW90-60	183	WK-D0430-001	153	W-WOBU60-VE-10	191	WW-WSL000-01	200
WG-POBUWM60-10	184	WK-D0440-001	153	W-WOBU60-VE-60	190	WW-WSP000-01	200
WG-POBUWM60-60	184	WK-D0460-001	153	W-WOBU70-BP-10	191	WW-WSP00-01	200
WG-POBUWM70-10	184	WK-D3516-001	153	W-WOBU70-BP-60	190	WW-WUBR00-01	201
WG-POBUWM70-60	184	WK-D3530-001	153	W-WOBU70-VE-10	191	WW-ZWBUT2-10	203
WG-POBUWM80-10	184	WK-DOW63X31G-D	154	W-WOBU70-VE-60	190	WW-ZWBUT2-20	203
WG-POBUWM80-60	184	WK-DOW63X35B-D	154	W-WOBU80-BP-10	191	WZ-00-K24-04	338
WG-POBUWM90-10	184	WK-DOW63X39-D	154	W-WOBU80-BP-60	190	WZ-804-20-01	323
WG-POBUWM90-60	184	WK-DOW63X45B-D	154	W-WOBU80-VE-10	191	WZ-804-20-05	323
WG-PRZEG60-10	185	WK-SZ-AS-400-10	126	W-WOBU80-VE-60	190	WZ-804-20-06	323
WG-PRZEG60-60	185	WK-SZ-AS-400-60	126	W-WOBU90-BP-10	191	WZ-A0-K23-01	328
WG-PRZEG70-10	185	WK-SZ-AS-500-10	126	W-WOBU90-BP-60	190	WZ-A0-K23-02	328
WG-PRZEG70-60	185	WK-SZ-AS-500-60	126	W-WOBU90-VE-10	191	WZ-A0-K23-03	328
WG-PRZEG80-10	185	WK-SZ-AS-600-10	126	W-WOBU90-VE-60	190	WZ-A0-K23-04	328
WG-PRZEG80-60	185	WK-SZ-AS-600-60	126	W-WSPD60-BP-10	193	WZ-A0-K23-05	328
WG-PRZEG90-10	185	WK-SZ-AS-800-10	126	W-WSPD60-BP-60	192	WZ-A0-K23-06	328
WG-PRZEG90-60	185	WK-SZ-AS-800-60	126	W-WSPD60-VE-10	193	WZ-A0-K23-07	328
WG-RDR0-10	187	WK-SZ-AS-900-10	126	W-WSPD60-VE-60	192	WZ-A0-K23-20	328
WG-RDR0-60	187	WK-SZ-AS-900-60	126	W-WSPD70-BP-10	193	WZ-A0-K24-01	330
WG-RDRP-10	187	W-WKO60-BP-10	195	W-WSPD70-BP-60	192	WZ-A0-K24-02	330
WG-RDRP-60	187	W-WKO60-BP-60	194	W-WSPD70-VE-60	192, 193	WZ-A0-K24-03	330
WG-RRPSET-A-10	187	W-WKO60-VE-10	195	W-WSPD80-BP-10	193	WZ-A0-K24-04	330
WG-RRPSET-A-60	187	W-WKO60-VE-60	194	W-WSPD80-BP-60	192	WZ-A0-K24-05	330
WG-RRPSET-B-10	187	W-WKO70-BP-10	195	W-WSPD80-VE-10	193	WZ-A0-K24-07	330
WG-RRPSET-B-60	187	W-WKO70-BP-60	194	W-WSPD80-VE-60	192	WZ-A0-K24-20	330
WG-WSP0D60-10	186	W-WKO70-VE-10	195	W-WSPD90-BP-10	193	WZ-B0-K23-01	328
WG-WSP0D60-60	186	W-WKO70-VE-60	194	W-WSPD90-BP-60	192	WZ-B0-K23-02	328
WG-WSP0D70-10	186	W-WKO80-BP-10	195	W-WSPD90-VE-10	193	WZ-B0-K23-03	328
WG-WSP0D70-60	186	W-WKO80-BP-60	194	W-WSPD90-VE-60	192	WZ-B0-K23-04	328
WG-WSP0D80-10	186	W-WKO80-VE-10	195	WW-WSD250-01B	202	WZ-B0-K23-05	328
WG-WSP0D80-60	186	W-WKO80-VE-60	194	WW-WSD300-01B	202	WZ-B0-K23-06	328
WG-WSP0D90-10	186	W-WKO90-BP-10	195	WW-WSD350-01B	202	WZ-B0-K23-07	328
WG-WSP0D90-60	186	W-WKO90-BP-60	194	WW-WSD400-01B	202	WZ-B0-K23-20	328
WK-CAM-15-12-D	154	W-WKO90-VE-10	195	WW-WSD450-01B	202	WZ-B0-K24-01	330
WK-CF0750-01	155	W-WKO90-VE-60	194	WW-WSD500-01B	202	WZ-B0-K24-02	330
WK-CF6450-01	155	W-WKRP-BP-10	196	WW-WSL250-01	201	WZ-B0-K24-03	330

WZ-B0-K24-04	330	WZ-K2201-06	327	ZK-STRONG-KPL	150	ZM-INHC080BEO	18
WZ-B0-K24-05	330	WZ-K2201-CZ	327	ZK-ZAS-KPL-10	151	ZM-INHC080ZEO	18
WZ-B0-K24-07	330	WZ-K2202-01	327	ZK-ZAS-KPL-31	151	ZM-INHC090BEO	18
WZ-B0-K24-20	330	WZ-K2202-06	327	ZK-ZAS-KPL-32	151	ZM-INHC090ZEO	18
WZ-C0-K24-01	332	WZ-K2202-CZ	327	ZK-ZAW-R0-10	149	ZM-KT45H2-BE	28
WZ-C0-K24-02	332	WZ-MADRYT-04	336	ZK-ZAW-R0-30	149	ZP-BICN070BEO	27
WZ-C0-K24-03	332	WZ-MADRYT-07	336	ZM-CNHC07BR2	17	ZP-BICN070ZEO	27
WZ-C0-K24-04	332	WZ-MADRYT-15	336	ZM-CNHC08BR2	17	ZP-BICN072BEO	27
WZ-C0-K24-05	332	WZ-MADRYT-20M	336	ZM-CNHC09BR2	16	ZP-BICN072ZEO	27
WZ-C0-K24-20	332	WZ-MALAG-C0-01	333	ZM-DCHC07-3DBEO	10	ZP-BICN080BEO	27
WZ-CORDOBA-01	326	WZ-MALAG-C0-02	333	ZM-DCHC07-3DZEO	10	ZP-BICN080ZEO	27
WZ-CORDOBA-06	326	WZ-MALAG-C0-05	333	ZM-DCHC08-3DBEO	9	ZP-BICN082BEO	27
WZ-CORDOBA-20M	326	WZ-MALAG-C0-20	333	ZM-DCHC08-3DZEO	9	ZP-BICN082ZEO	27
WZ-CORUNA-D-04	335	WZ-ORVIE-A0-09	337	ZM-DCHC09-3DBEO	9	ZP-BICN090BEO	26
WZ-CORUNA-D-07	335	WZ-ORVIE-B0-09	337	ZM-DCHC09-3DZEO	9	ZP-BICN090ZEO	26
WZ-CORUNA-D-17	335	WZ-SCTYLPR-BWK	148	ZM-ECHC07-3DBEO	15	ZP-BICN092BEO	26
WZ-CORUNA-D-20M	335	WZ-SCTYLPR-WK	148	ZM-ECHC07BEO	12	ZP-BICN092ZEO	26
WZ-CORUNA-M-04	335	WZ-TOLED-A0-01	324	ZM-ECHC07ZEO	12	ZP-BIDI07-3DBEO	24
WZ-CORUNA-M-07	335	WZ-TOLED-A0-02	324	ZM-ECHC08-3DBEO	15	ZP-BIDI08-3DBEO	24
WZ-CORUNA-M-17	335	WZ-TOLED-A0-05	324	ZM-ECHC08BEO	12	ZP-BIDI09-3DBEO	23
WZ-CORUNA-M-20M	335	WZ-TOLED-A0-06	324	ZM-ECHC08ZEO	12	ZP-CIBI7H0ZE	35
WZ-CRAFT-04	336	WZ-TOLED-A0-20M	324	ZM-ECHC09-3DBEO	14	ZP-CIBI8H0ZE	35
WZ-CRAFT-07	336	WZ-TOLED-B0-01	324	ZM-ECHC09BEO	10	ZP-CIBI9H0ZE	34
WZ-CRAFT-15	336	WZ-TOLED-B0-02	324	ZM-ECHC09H04-BE	13	ZP-CIG-070ZE	36
WZ-CRAFT-20M	336	WZ-TOLED-B0-05	324	ZM-ECHC09ZEO	10	ZP-CIG-07UZE	36
WZ-D-892-02	334	WZ-TOLED-B0-06	324	ZM-HCKT30-BE-S	19	ZP-CIG-090ZE	36
WZ-D-892-05	334	WZ-TOLED-B0-20M	324	ZM-HCKT30-ZE-S	19	ZP-CIG-09UBE	36
WZ-E-018-01	334	WZ-TOLED-C0-01	325	ZM-HCKT45-3DBEO-S	20	ZP-CIG-09UZC	36
WZ-E-018-02	334	WZ-TOLED-C0-02	325	ZM-HCKT45-BE-S	20	ZP-CIG-09UZE	36
WZ-E-018-05	334	WZ-TOLED-C0-05	325	ZM-HCKT45-ZE-S	20	ZP-CIG-170ZE	36
WZ-E-018-06	334	WZ-TOLED-C0-06	325	ZM-HCKT90-3DBEO-S	21	ZP-CIG-17UZE	36
WZ-E-018-20M	334	WZ-TOLED-C0-20M	325	ZM-HCKT90-BE-S	21	ZP-CIG-190ZE	36
WZ-K23-D1-01	329	WZ-WALENCIA-01	326	ZM-HCKT90-ZE-S	21	ZP-CIG-19UZE	36
WZ-K23-D1-02	329	WZ-WALENCIA-06	326	ZM-HCKT155BE	22	ZP-CIHC070ZE	34
WZ-K23-D1-05	329	WZ-WALENCIA-20M	326	ZM-HCKT155ZE	22	ZP-CIHC080ZE	33
WZ-K23-D1-06	329			ZM-HCKT165-3DBEO-S	23	ZP-CIHC090ZE	33
WZ-K23-E1-01	329	Z		ZM-HCKT165BE-S	22	ZP-COCA450-BE	31
WZ-K23-E1-02	329	ZC-GTV-12-00	40	ZM-HCKT165ZE-S	22	ZP-COCA450-ZE	31
WZ-K23-E1-05	329	ZC-GTV-14-00	40	ZM-HCRALU9BE	37	ZP-COCA7450-BE	31
WZ-K23-E1-06	329	ZK-FORCE-KPL	149	ZM-INHC070BEO	19	ZP-CONL07-BE	26
WZ-K2201-01	327	ZK-R1-KPL-10	150	ZM-INHC070ZEO	19	ZP-CONL07-ZE	26

ZP-CONL08-BE	25	ZP-KT165H2BE	30	ZZ-16-103-01	235	ZZ-G0-328-01	237
ZP-CONL08-ZE	25	ZP-KT165H2ZE	30	ZZ-20-103-01	235	ZZ-KLMASTER	233
ZP-CONL09-BE	25	ZP-KT0270-BE	38	ZZ-30-103-01	235	ZZ-KM-138-01	232
ZP-CONL09-ZE	25	ZP-KTK90H6BE	29	ZZ-B0-105-01	234	ZZ-M0-201-01	236
ZP-JUNIOR-00	39	ZP-KTK90H6ZE	29	ZZ-BA-SK0-01	237	ZZ-SP-105-05	238, 425
ZP-KT30H2-BE	28	ZP-PO7H045BE	32	ZZ-BA-SK0-PR	237	ZZ-SP-KLMASTER	238
ZP-KT45H2-ZE	28	ZP-POH045BE0	32	ZZ-C1-288-01	238	ZZ-SZ-409-01	235
ZP-KT90H2-BE	29	ZP-POH045ZE0	32	ZZ-C5-288-01	238	ZZ-Z0-202-01	236
ZP-KT90H2-ZE	29	ZP-RALUH2-00	37	ZZ-C6-288-01	238	ZZ-ZN-138-01	232
ZP-KT135H2BE	30	ZP-SKR-00-80	40	ZZ-C8-288-01	238	ZZ-ZN-338-01	234
ZP-KT135H2ZE	30	ZT-HF-01-D00	38, 39	ZZ-CF-138-01	233		

Niniejszy katalog produktów został przygotowany przez GTV Poland. Poprzez ciągłe udoskonalanie swojej oferty, zgodnie z wymogami rynkowymi i prawnymi, GTV Poland zastrzega sobie prawo do wprowadzania zmian w przedstawionym asortymencie. Prezentowana publikacja nie jest ofertą w rozumieniu Kodeksu Cywilnego. Rzeczywiste produkty mogą odbiegać od poglądowych zdjęć i rysunków zamieszczonych w publikacji. GTV Poland zastrzega sobie prawo do zmian i błędów w druku.

This product catalogue has been prepared by GTV Poland. Constantly improving its products so as to follow market and legal requirements, GTV Poland reserves the right to introduce changes in the presented product range. The present publication does not constitute an offer within the meaning of the Civil Code. The real products can differ from the example photographs and drawings in the publication. GTV Poland reserves the right to make changes and printing errors.

Данный каталог был создан компанией GTV Poland. В соответствии с действующим законодательством и требованиями рынка, компания GTV Poland оставляет за собой право вносить изменения в ассортимент предлагаемого товара. Данная публикация носит информационно-ознакомительный характер и не является коммерческим предложением в понимании права. Компания не несет ответственности за возможные цветовые расхождения, опечатки и неточности.



GTV

ul. Przejazdowa 21
05-800 Pruszków
Poland

 +48 22 44 47 272

 +48 22 44 47 366

+48 22 44 47 331

 +48 22 44 47 391

 + 48 22 44 47 379

 + 420 591 160 091

 +48 22 444 73 24

+48 22 444 73 07

 +375 291 504 626

+48 22 44 47 523

 +48 22 44 47 524

+48 735 201 464

 +48 22 4447 525

 +48 22 44 47 277

+48 539 770 636

 ООО «ГТВ РУС»
140073 Московская область
город Люберцы, рабочий посёлок Томилино
мкрн. Птицефабрика, Литер 7А

 GTV Croatia d.o.o
Kovinska 4a, 10000 Zagreb
Hrvatska
+ 385 1798 8089

 GTV Czech Distribution s.r.o.
CTPark Ostrava, Na Rovince 879
720 00 Ostrava-Hrabová
Česká republika
+420 591 160 092
+420 727 800 362
+420 725 715 142

 GTV España Herrajes e Iluminación,
S.L., Avenida Aragón 30, Planta 8
46021 Valencia (España)
+ 34 960 468 666
+ 48 22 444 73 77

fax: +48 22 444 75 01
e-mail: info@gtv.com.pl
www.gtv.com.pl

